

GL·iNet



User Manual

GL-MT3600BE / Beryl 7

Dual-Band Wi-Fi 7 Travel Router

About This Manual

This manual is your go-to resource for getting started with your device, covering basic product information, hardware connections, web management interface login, initial setup, and detailed instructions for all software features in the web admin panel.

With this guide, you will be able to:

- Understand key product details
- Choose a suitable location for the device
- Complete hardware connections via step-by-step guidance
- Log into the web management interface with ease
- Configure initial settings and master all software features in the web admin panel

Format Conventions

These symbols/colors help you follow steps faster.

Convention	What It Means
Underlined teal text	Clickable link which can open a web page or a specific section
Bold text	Emphasize or mark some key information in this document, such as titles, hyperlinks, and exact menu/item names on the device's web interface
>	The path to load the corresponding page (e.g., System > Firmware)
Note	Key information for setup, operations, and safety. Ignoring this might result in setup failure, device malfunction or damage
Tips	Advice to help you use your device better

Note:

- Device features may vary by model and firmware version.
- Product availability is subject to regional differences or ISP specifications.
- All images, procedures, and descriptions in this guide are for illustrative purposes only and may differ from your actual usage experience.

Need More Help or Info?

- Firmware Update: [GL.iNet Firmware Download Center | Router](#)
- Community: Discuss our products and share insights at [GL.iNet Community Forum](#)
- Technical Support: Contact our Technical Support at [Contact page](#)

Copyright © 2026 GL.iNet Technology (HK) Ltd. All rights reserved.

No part of this manual may be reproduced, transcribed, translated, or distributed in any form or by any means, without the prior written permission of GL.iNet Technology (HK) Ltd. GL.iNet is a registered trademark of GL.iNet Technology (Hong Kong) Ltd. in China and/or other countries and regions. All other brand and product names mentioned herein are trademarks or registered trademarks of their respective owners.

The content of this document is subject to change without notice due to product version upgrades or other reasons. Unless otherwise agreed, this document is provided for informational purposes only, and all statements, information, and recommendations contained herein do not constitute any form of warranty.

GL Tech (HK) Ltd: #601, 5W, Hong Kong Science Park, N.T. Hong Kong

GL Intelligence, Inc.: 10400 Eaton Place, Suite 215, Fairfax, VA 22030

Contents

Chapter 1 Get To Know Your Router	6
1.1 Product Overview	7
1.1.1 Appearance	7
1.1.2 Interface and Button	8
1.1.3 LED	9
1.2 Specifications	9
1.3 Package Contents	10
Chapter 2 Hardware Connection	11
2.1 Choosing a Location	12
2.2 Connecting the Router	12
Chapter 3 Log In To Your Router	13
Chapter 4 Set Up Internet Connection	15
4.1 Quick Setup Wizard	16
4.2 Manually Set Up Internet Connection	17
4.2.1 Connect to the Internet via Ethernet Cable	18
4.2.2 Connect to the Internet via an Existing Wi-Fi	23
4.2.3 Connect to the Internet via USB Tethering	29
4.2.4 Connect to the Internet via USB Modem	34
Chapter 5 Wireless	36
5.1 Wi-Fi Status Display	37
5.2 Wireless Settings	38
5.2.1 MLO Wi-Fi	38
5.2.2 5GHz Wi-Fi	40
5.2.3 2.4GHz Wi-Fi	42
5.2.4 Randomized BSSID	44
Chapter 6 Clients	46
6.1 Device Details	48
6.2 Action	50
6.3 Remove Clients	53
6.4 Sort	54
Chapter 7 Cloud Services	55

7.1 GoodCloud	56
7.1.1 Enable GoodCloud	57
7.1.2 Manage Your Router	59
7.1.3 Unbind Device	64
7.1.4 Disable GoodCloud	64
7.2 AstroWarp	65
Chapter 8 Get To Know VPN	66
8.1 Introduction	67
8.2 Application Scenarios	68
Chapter 9 VPN Dashboard	70
9.1 VPN Setup Wizard	71
9.2 VPN Mode	74
9.2.1 Global Mode	75
9.2.2 Policy Mode	77
Chapter 10 Set Up VPN Server	86
10.1 Set Up OpenVPN Server	87
10.1.1 Preparation	87
10.1.2 Setup Steps	88
10.1.3 Troubleshooting	90
10.2 Set Up WireGuard Server	91
10.2.1 Preparation	91
10.2.2 Setup Steps	92
10.2.3 Troubleshooting	95
Chapter 11 Set Up VPN Client	96
11.1 Set Up OpenVPN Client	97
11.1.1 Preparation	97
11.1.2 Set Up NordVPN	97
11.1.3 Set Up OpenVPN Client Manually (for other providers)	103
11.2 Set Up WireGuard Client	106
11.2.1 Preparation	106
11.2.2 Set Up AzireVPN	107
11.2.3 Set Up Hide.me	111
11.2.4 Set Up IPVanish	114
11.2.5 Set Up Mullvad	118

11.2.6 Set Up NordVPN	122
11.2.7 Set Up PIA (Private Internet Access)	127
11.2.8 Set Up PureVPN	131
11.2.9 Set Up Surfshark	134
11.2.10 Set Up Windscribe	138
11.2.11 Set Up WireGuard Client Manually (for other providers)	143
Chapter 12 Tor	148
Chapter 13 Applications	150
13.1 Plug-ins	151
13.2 Dynamic DNS	152
13.2.1 Enable DDNS	152
13.2.2 Check if DDNS Works	155
13.2.3 HTTPS Remote Access	157
13.2.4 SSH Remote Access	160
13.3 Network Storage	162
13.3.1 Connect Storage	162
13.3.2 Set Up Samba	163
13.3.3 Set Up WebDAV	166
13.3.4 Set Up DLNA	169
13.4 AdGuard Home	170
13.5 Parental Control	172
13.5.1 Quick Setup	172
13.5.2 Troubleshooting	180
13.6 Tailscale	181
13.6.1 Set Up Tailscale	182
13.6.2 Allow Remote Access WAN	185
13.6.3 Allow Remote Access LAN	185
13.6.4 Custom Exit Nodes	186
13.7 ZeroTier	187
13.7.1 Set Up ZeroTier	188
13.7.2 Allow Remote Access WAN	192
13.7.3 Allow Remote Access LAN	193
Chapter 14 Network	194
14.1 Port Forwarding	195

14.1.1 DMZ	195
14.1.2 Port Forwarding	196
14.2 Multi-WAN	198
14.2.1 Interface Status Track	198
14.2.2 Multi-WAN Mode	201
14.3 LAN	204
14.3.1 Basic Settings	204
14.3.2 DHCP Server	205
14.3.3 Address Reservation	207
14.4 Guest Network	208
14.4.1 Basic Settings	208
14.4.2 DHCP Server	209
14.5 DNS	211
14.5.1 DNS Server Settings	212
14.5.2 Edit Hosts	214
14.6 Ethernet Port	216
14.7 Network Mode	217
14.8 IPv6	219
14.8.1 IPv6 Mode	220
14.8.2 DNS acquisition method	220
14.9 Drop-in Gateway	221
14.10 IGMP Snooping	223
14.11 Network Acceleration	224
14.12 NAT Settings	225
Chapter 15 System	226
15.1 Overview	227
15.2 Upgrade	228
15.2.1 Online Upgrade	228
15.2.2 Local Upgrade	229
15.3 Scheduled Tasks	230
15.3.1 LED Display Schedule	230
15.3.2 Schedule Reboot	231
15.3.3 MLO Wi-Fi Schedule	231
15.3.4 5GHz Wi-Fi Schedule	232

15.3.5 2.4GHz Wi-Fi Schedule	234
15.4 Time Zone	237
15.5 Toggle Button Settings	238
15.6 Log	239
15.7 Security	241
15.7.1 Admin Password	241
15.7.2 Access Control	242
15.7.3 Remote Access Control	244
15.7.4 Open Ports on Router	245
15.8 Reset Firmware	246
15.9 Advanced Settings	247
Regulatory and Legal	249

Chapter 1

Get To Know Your Router

This chapter covers the router overview, specifications, and package contents.

1.1 Product Overview

Beryl 7 is a compact dual-band Wi-Fi 7 travel router that delivers super fast VPN speeds (up to 1100 Mbps via WireGuard®) in GL.iNet's travel router lineup. With PD compatibility, it can be powered using a standard phone charger cable, reducing the weight and clutter in your luggage. Capable of supporting 120+ devices concurrently-all in a sleek, portable design built for life on the go.

1.1.1 Appearance



1.1.2 Interface and Button

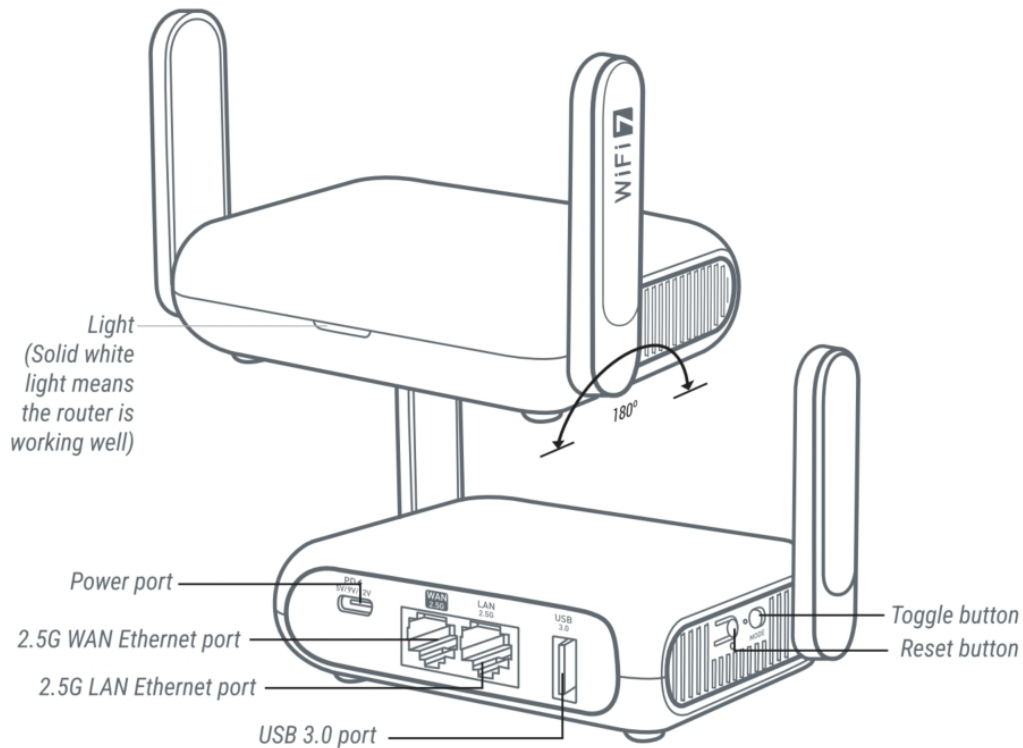

Item	Description
Power Port	For connecting the power adapter.
2.5G WAN Port	For connecting to a modem or an Ethernet outlet.
2.5G LAN Port	For connecting wired devices to the router.
USB 3.0 Port	For connecting a USB storage device to the router.
Reset Button	Press and hold for 4 seconds to repair your network; Press and hold for 10 seconds and then release to reset the router to factory default.
Toggle Button	A physical switch that toggles selected router settings with a flip. You can configure it in the web admin panel to enable one-click switching of specific features.

1.1.3 LED

Status	Indication
Solid Blue	Starting up
Pulsing Blue Slowly	Started but no Internet connection
Solid White	Connected to Internet
Flashing Blue Quickly	Resetting

1.2 Specifications

Interface	1 x 2.5G WAN Ethernet port 1 x 2.5G LAN Ethernet port 1 x Type-C Power port 1 x USB 3.0 port 1 x Reset Button 1 x Toggle button
CPU	MediaTek, Quad-core @2.0GHz
Memory / Storage	DDR4 512MB / NAND Flash 512MB
Protocol	IEEE 802.11a/b/g/n/ac/ax/be
Wi-Fi Speed	688Mbps (2.4GHz), 2882Mbps (5GHz)
Antennas	2 x Foldable External Wi-Fi Antennas
Ethernet Speed	10/100/1000/2500Mbps
Power Input	Type-C, 5V/3A, 9V/3A, 12V/2.5A
Power Consumption	<12W (without USB load)
Operating Temperature	0 ~ 40°C (32 ~ 104°F)
Storage Temperature	-20 ~ 70°C (-4 ~ 158°F)
Dimension / Weight	120 x 83 x 34mm / 205g
Other Tools	Datasheet / Firmware / App / Unboxing / Tutorials

*Wireless speeds are based on IEEE 802.11 standards (e.g., 802.11be for Wi-Fi 7). Actual throughput and range may be lower due to environmental obstacles (walls, metal), network congestion, or client device capabilities.

*Use of Wi-Fi 7 (802.11be) and its features (OFDMA, MU-MIMO, 4096-QAM, MLO) requires client devices to support the corresponding technologies.

1.3 Package Contents

The package includes:

- 1 x Beryl 7 (GL-MT3600BE)
- 1 x Quick Start Guide
- 1 x Ethernet Cable
- 1 x Thank You Card
- 1 x Power Adapter
- 3 x Converters (EU, UK, and AU Plugs)

Chapter 2

Hardware Connection

This chapter covers router location selection and connection steps.

2.1 Choosing a Location

Follow these tips to choose a location for best performance.

- **Avoid moisture and heat:** Do not place the router in areas exposed to water, humidity, or high temperatures (e.g., sinks, radiators).
- **Ventilation and cooling:** Place the router in a cool, well-ventilated area for proper heat dissipation.
- **Central placement:** Position the router where it can connect to power and multiple devices easily (e.g., living room central zone).
- **Cable convenience:** Route cables and the power cord safely to prevent tripping hazards.
- **Stable surface:** Place the router on a horizontal, flat surface (shelf, desktop) for stability.
- **EMI avoidance:** Keep the router away from electromagnetic interference sources (Bluetooth devices, microwaves) to minimize signal interference.

2.2 Connecting the Router

1. Power on

Put the two-piece power adapter together. Connect it to the router and plug it into an outlet. It will start up automatically.

2. Connect a device to the router

Connect a device (e.g., laptop or smartphone) to the router via Wi-Fi or an Ethernet cable.

- **Wi-Fi:** On your device, go to Settings -> WLAN, locate the router's Wi-Fi network name in the available networks list and enter the password. You can find the default network name and password printed on your router's label.
- **Ethernet:** Connect your device to the router's LAN port via an Ethernet cable.

3. Log in to the router

The Internet is unavailable when connecting to the router for the first time. Please log in to the router as instructed in Chapter 3 to complete the initial setup before accessing the Internet.

Chapter 3

Log In To Your Router

This chapter guides you to log in to your router via web admin panel.

Configure and manage your router through a web-based management interface, which can be accessed on any Windows, Mac OS or Linux OS with a web browser, such as Microsoft Edge, Google Chrome, Mozilla Firefox or Apple Safari.

Note: If you prefer using the GL.iNet app instead of the web admin panel, [download the app](#) and follow the on-screen prompts.

Follow the steps below to log in to your router via the web admin panel.

1. Connect a device (e.g., a computer or laptop) to the router via Wi-Fi or an Ethernet cable.
2. Open a web browser (Chrome and Edge are recommended) and visit <http://192.168.8.1>. You will be directed to the login page of the web admin panel. If you fail to access the web admin panel, see [here](#) for troubleshooting.
3. Set up your admin password. A strong password is recommended for security. Then click **Next** to continue.
4. You will then enter the router's web admin panel.

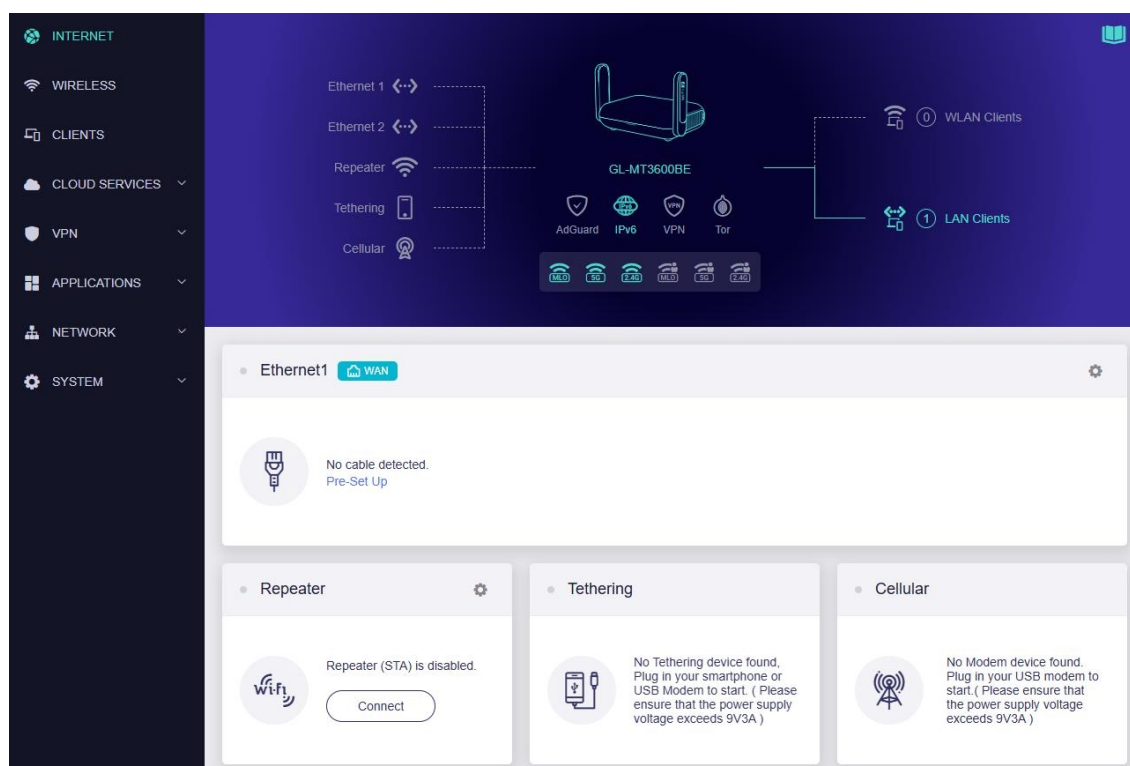

Chapter 4

Set Up Internet Connection

This chapter introduces multiple Internet connection methods for the router to adapt to diverse network environments.

4.1 Quick Setup Wizard

The Web-based Setup Wizard will guide you through the router network configuration.

Follow the steps below to start the wizard.

1. Log in to the router's web admin panel as instructed in [Chapter 3](#).
2. On the homepage, click the book icon in the top right corner.

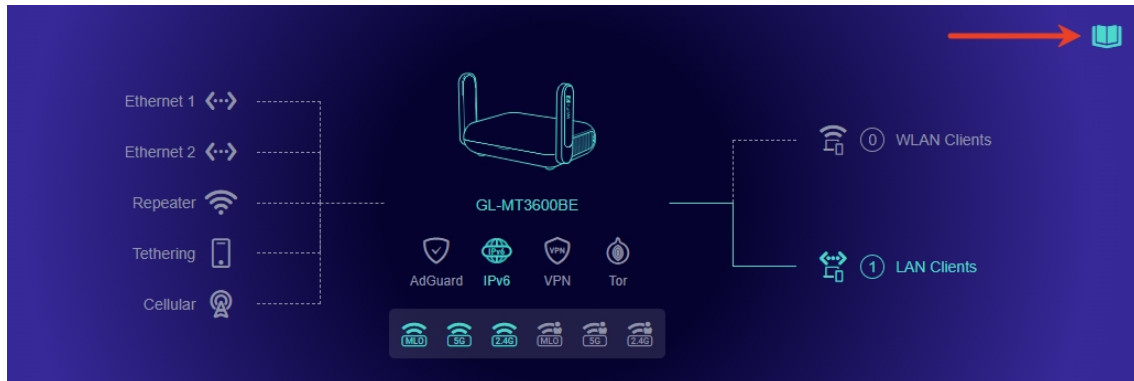

3. Follow the Setup Wizard to configure your router and establish an internet connection.

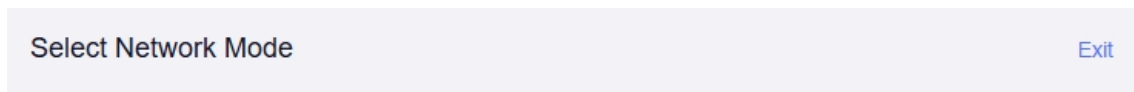

Network Guide

The Network guide helps you configure your router network for fast Internet access in no time.

Suggest

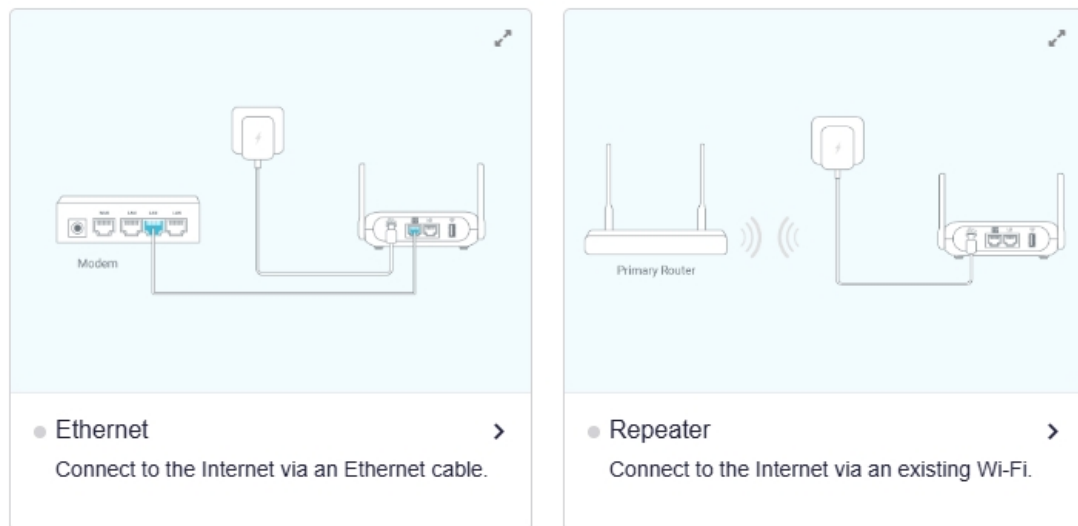

If using the [GL.iNet app](#), follow the on-screen prompts to set up internet access.

4.2 Manually Set Up Internet Connection

While the Setup Wizard is convenient for quick network setup, manual setup allows you to adjust advanced network settings for specific requirements, and check or modify existing connections as needed.

Beryl 7 supports four internet connection methods: Ethernet, Repeater, USB Tethering, and USB Modem. Choose the appropriate method based on your usage needs.

1. **Ethernet:** Connect the router to a broadband network using an Ethernet cable plugged into the WAN port. The router typically obtains an IP address automatically via DHCP. Users can also manually configure a static IP or PPPoE settings. This method delivers high stability and fast speed, making it ideal for home and office environments with fixed broadband access.
2. **Repeater:** This mode enables the router to connect to an existing Wi-Fi network to extend the Wi-Fi signal and create a separate, secure local network. Note that transmission speeds may be reduced to some extent. It is ideal for Wi-Fi dead zones that require signal extension, or public locations where enhanced network security is needed.
3. **USB Tethering:** Connect a smartphone or other compatible device to the router via a USB cable to share the device's mobile data connection (e.g., 4G/5G) with the router. This is a convenient solution for temporary internet access, especially when outdoors or in areas without fixed broadband.
4. **USB Modem:** Insert a USB cellular modem with a pre-installed SIM card into the router. The router will then connect to the internet via 4G/5G mobile networks, providing connectivity independent of fixed-line broadband. This method offers high mobility and is suitable for scenarios such as in-vehicle use or outdoor activities.

4.2.1 Connect to the Internet via Ethernet Cable

Connect the router to a broadband network using an Ethernet cable plugged into the WAN port. The router typically obtains an IP address automatically via DHCP. Users can also manually configure a static IP or PPPoE settings. This method delivers high stability and fast speed, making it ideal for home and office environments with fixed broadband access.



Basic Setup

Follow the steps below to connect your router to the Internet via an Ethernet cable.

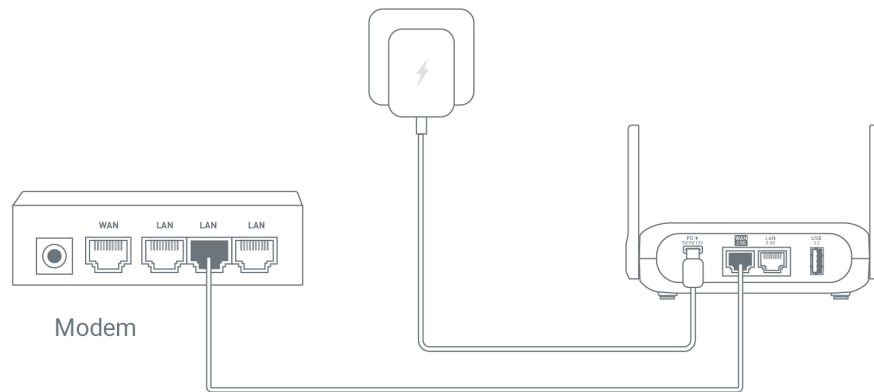
1. Connect the **WAN** port of your router to the upstream device (e.g., an ISP modem, primary router, network switch or an Ethernet jack) via an Ethernet cable.



2. Log in to the router's web admin panel and navigate to **INTERNET > Ethernet**. If the connection is successful, the Ethernet section will display network details, including Protocol, IP Address, Gateway, and DNS Server.

● Ethernet 1  

Protocol	DHCP
IP Address	192.168.11.163
Gateway	192.168.11.1
DNS Server	192.168.11.1



[Modify](#)

Protocol

There are three types of protocols: DHCP, Static and PPPoE. Click **Modify** to change.

Ethernet 1 WAN ⚙️

Protocol	DHCP
IP Address	192.168.11.163
Gateway	192.168.11.1
DNS Server	192.168.11.1

🔌

➡️ Modify

- **DHCP**

DHCP is the default and most common network protocol, which automatically assigns IP addresses and other network configuration parameters to devices on an IP network via a client-server model.

Ethernet Settings

Protocol DHCP Static PPPoE

ℹ️ IP address is assigned by higher network machine.

IPv4

IP Address	192.168.116.215
Netmask	255.255.255.0
Gateway	192.168.116.254
DNS Server 1	223.5.5.5
DNS Server 2	223.6.6.6

Cancel Apply

- **Static**

A static IP address is required if your ISP (Internet Service Provider) assigns a fixed public IP address, or if you need to manually configure network parameters (e.g., IP address, gateway, subnet mask).

Ethernet Settings

Protocol DHCP **Static** PPPoE

IPv4

IP Address

Netmask

Gateway

DNS Server 1

DNS Server 2

VLAN ID ⓘ

Cancel Apply

- **PPPoE**

PPPoE (Point-to-Point Protocol over Ethernet) is a network protocol widely used by ISPs. Typically, they will provide a modem along with a unique username and password, which are required to set up an internet connection.

Ethernet Settings

Protocol DHCP Static **PPPoE**

PPPoE Setting

Username

Password

VLAN ID ⓘ

TTL ⓘ

HL ⓘ

MTU ⓘ

Cancel Apply

Advanced Settings

In addition to the essential settings, there are also some optional advanced settings for the above three protocols.

The screenshot shows the 'Ethernet Settings' configuration page. Under the 'IPv4' section, the following fields are visible:

IP Address	192.168.116.221
Netmask	255.255.255.0
Gateway	192.168.116.254
DNS Server 1	223.5.5.5
DNS Server 2	223.6.6.6

Below these are the advanced settings, which are highlighted with a red box in the image:

VLAN ID ⓘ	Optional (1 ~ 4094)
TTL ⓘ	Optional
HL ⓘ	Optional
MTU ⓘ	1500

At the bottom of the settings panel are 'Cancel' and 'Apply' buttons.

- **VLAN ID**
This setting is needed only if the provider's server requires the interface to use a specific tagged VLAN ID.
- **TTL**
TTL (Time To Live) defines the maximum time packets can survive in the network. By default, the router decrements the TTL of incoming packets from client devices by 1 before forwarding them. If you need to override it, you can set a fixed value here. The TTL setting is valid only for IPv4.
- **HL**
In IPv6, the HL (Hop Limit) field limits the number of transmission hops for data packets in the network, serving as the equivalent of TTL in IPv4.
- **MTU**
The default MTU value is 1500 bytes.

4.2.2 Connect to the Internet via an Existing Wi-Fi

Connect the router as a repeater to the existing wireless network to boost Wi-Fi signals and create a local network isolated from the primary network. When in hotels or cafes with free public hotspots, using a repeater not only strengthens Wi-Fi signals, but also provides wired and wireless access for multiple devices, and safeguards your network security.

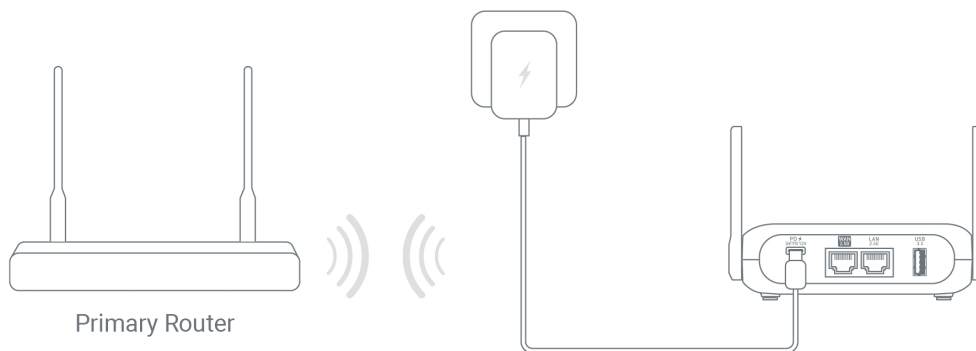

GL.iNet repeater feature works in WISP (Wireless Internet Service Provider) mode by default, which means that the router will create its own subnet and act as a firewall to protect you from the public network.

Basic Setup

Follow the steps below to connect your router to an existing Wi-Fi as a repeater.



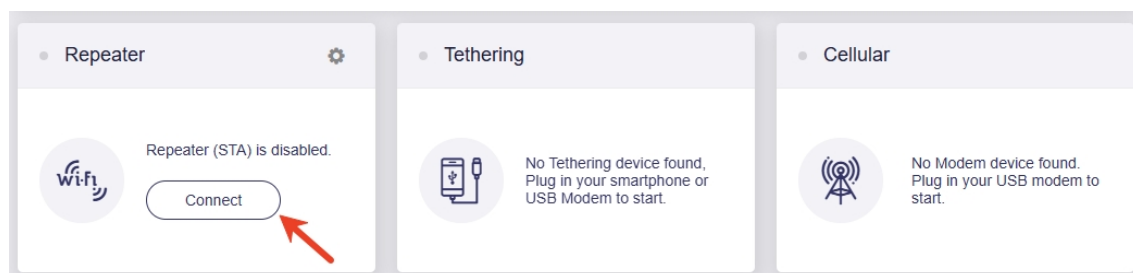





1. Log in to the router's web admin panel, and navigate to **INTERNET** -> **Repeater**. Click **Connect**.



2. In the pop-up window, choose the Wi-Fi network you want to connect from the available network list.

Join Wi-Fi ↻ ×

Available Networks ⓘ Join Other Network

 GL-BE9300-e52	2.4G
 GL-MT6000-787	2.4G
 GL-MT300N-V2-184	2.4G
 GL-MT6000-787-5G	5G
 GL-XE300-407	2.4G
 GL-AX1800-f4e	2.4G
 GL-AX1800-f4e-5G	5G
 GL-MT6000-27b	2.4G
 GL-BE9300-f58-MLO	Mixed

3. Enter the correct Wi-Fi password and click **Apply**.

Join Network ×

SSID

Password

Auto-Enable Login Mode for Public Hotspots ⓘ

Enable Camouflage ⓘ

MAC Mode

MAC Address 6E:FD:E3:24:2A:EF [Random](#)

Auto Update MAC ⓘ

[Advanced Settings](#)

If the target Wi-Fi SSID is not in the Available Network list, click **Join Other Network** in the top right corner, manually input the Wi-Fi SSID and other info required, and click **Apply**.

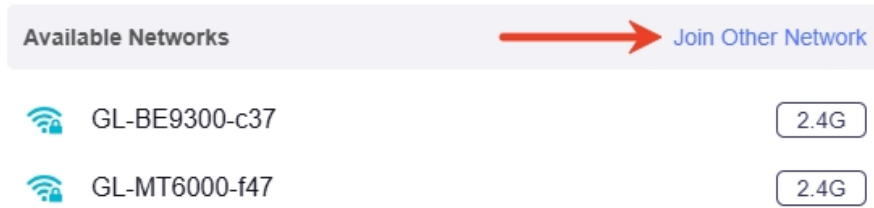

4. Wait a minute for the router to connect. Once connected, the page displays as below.

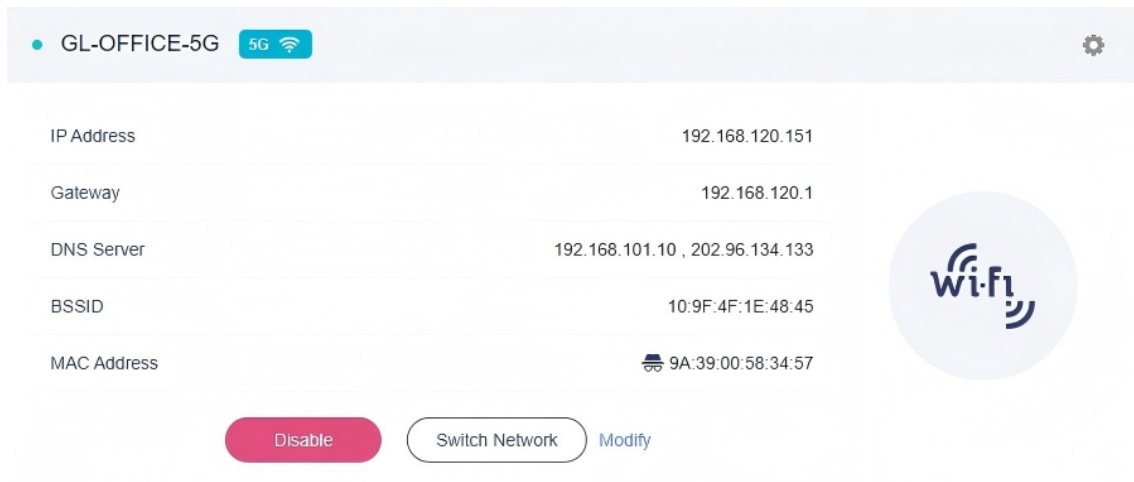

Public Hotspot Settings

When connecting the router to a public hotspot with a captive portal, it is recommended to enable the following features to improve the connection success rate.

Join Network Exit

SSID

Password

Auto-Enable Login Mode for Public Hotspots

Enable Camouflage

MAC Mode

MAC Address 7A:55:9A:AE:2E:20 [Random](#)

Auto Update MAC

[Advanced Settings](#)

Back Apply

- **Auto-Enable Login Mode for Public Hotspots**

If enabled, the router automatically enters Public Hotspot Login Mode when it is connected to a hotspot but not the Internet. In this mode, some services will be suspended while DNS mode switches to automatic, which may leak your network activity to the network provider (e.g., hotel, shopping mall). Even if disabled, the router will prompt you to enter this mode if it detects a hotspot captive portal or fails to log in.

● portal--GL-MT3000-a80-5G 5G 📶

⚠ Can't access the internet via the repeated hotspot. Try to enter [Login Mode for Public Hotspots](#) to fix the issue.

IP Address	192.168.20.226
Gateway	192.168.20.1

- **Enable Camouflage**

If enabled, the router will masquerade as the client device you use to access the admin panel by emulating that device's MAC address.

- **MAC Mode**

Choose which MAC address the router uses to connect to the public hotspot.

Factory: Uses the device's original factory-assigned MAC address.

Clone: Clones a client device's MAC address for connection.

If the desired MAC isn't listed, manually enter the MAC address you want to clone. Note:

Many devices use randomized MAC addresses (often called Private Wi-Fi Address or random hardware address) when connecting to Wi-Fi networks. As a result, the MAC address displayed here may not match the device's actual physical MAC.

Random: Automatically generates a random MAC address for connection.

- **Auto Update MAC**

If this option is enabled, the MAC address will be updated automatically.

When saving the network configuration, the MAC Mode, including any cloned or randomized MAC address, will be tied to the specific SSID you save. You can manually change these settings for each SSID at any time.

Advanced Settings

When joining the network, there are some optional advanced settings.

Join Network ✕

MAC Mode Random ▼

MAC Address 52:E2:A5:85:9D:96 Random

Auto Update MAC i

Remember

Lock BSSID i

Manually Set Static IP

TTL i

HL i

MTU i

Back Apply

- **Remember:** Enable this to remember the current repeated Wi-Fi network. This is available in firmware v4.7 and later.
- **Lock BSSID:** If this option is enabled, the router will only connect to the AP corresponding to the BSSID you selected when switching to a network using this SSID.
- **Manually Set static IP:** This is available in firmware v4.7 and later.
- **TTL:** TTL (Time To Live) sets the maximum time for packets to survive in the network, and is filled in according to the requirements of the operator. By default, the router forwards the TTL of the incoming client device minus one. If you need to camouflage, you can set a fixed value here. the TTL is valid only for IPv4.
- **HL:** In IPv6, the HL (Hop Limit) field is used to limit the number of transmission hops of data packets in the network, which is equivalent to the TTL in IPv4.
- **MTU:** The default value is 1500.

4.2.3 Connect to the Internet via USB Tethering

Connecting a smartphone to the router through a USB cable is called Tethering, which can share the device's mobile data network (e.g., 4G/5G) with the router. This is a convenient method for temporary internet access, especially when outdoors or in areas without fixed broadband.

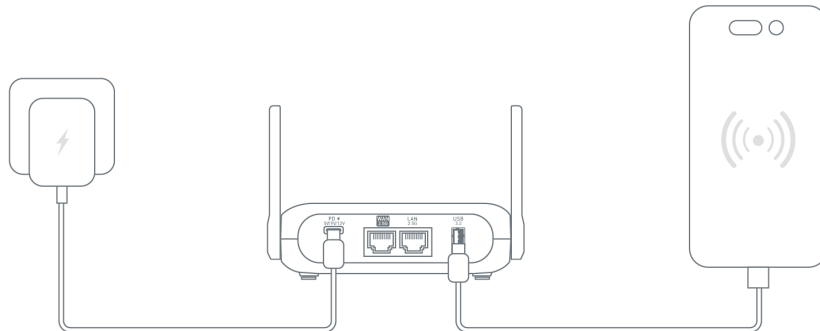

Host-less modem works in Tethering as well during the setup of the modem.

Note: Some mobile carriers limit or charge extra for tethering. We recommend checking with your carrier.

iPhone Tethering

1. Connect an iPhone to the router's USB port using a USB cable. A system dialog will appear asking whether to trust the device. Tap **Trust** to proceed.

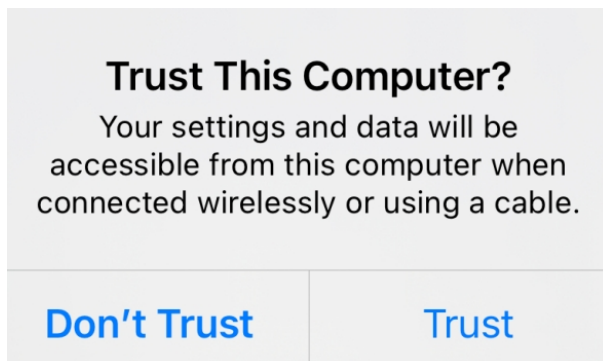

2. Go to iPhone **Settings** > **Personal Hotspot**. Enable **Allow Others to Join**.

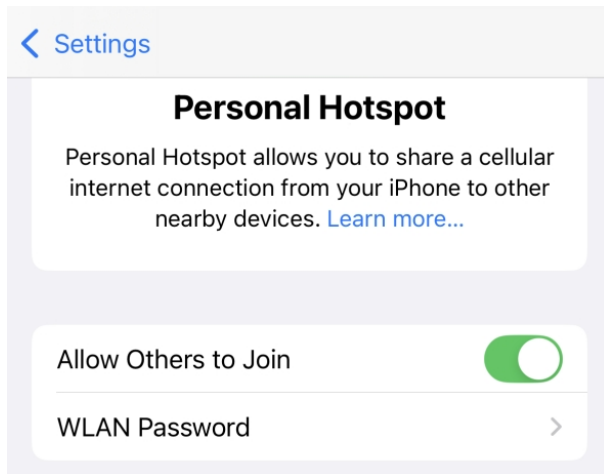

3. Connect a computer or another phone to the router. Log in to the router's web admin panel and navigate to **INTERNET > Tethering**, then click **Connect**.

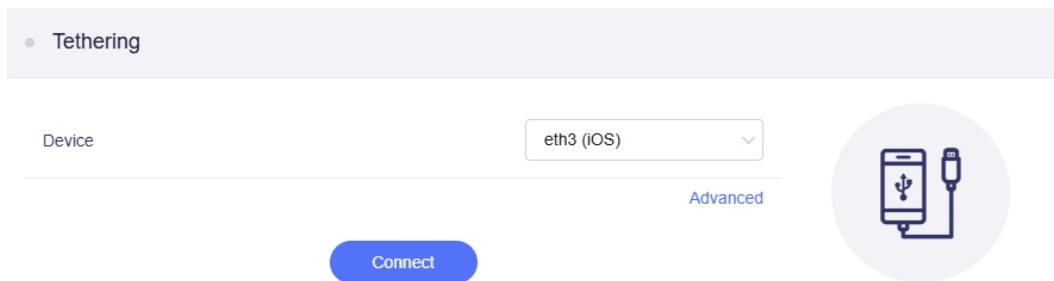

If you need to set advanced settings, such as TTL, HL, and MTU, click **Advanced** to customize these settings before clicking **Connect**.

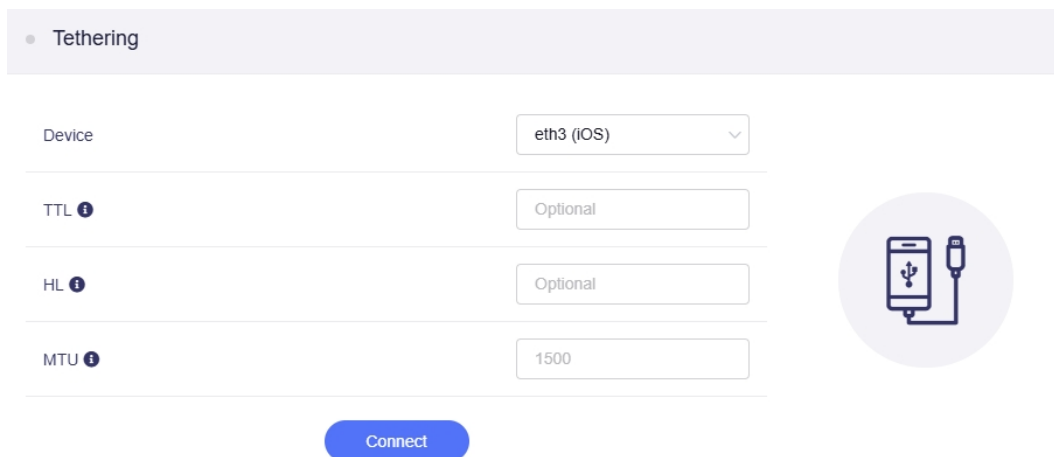

4. It will start connecting.

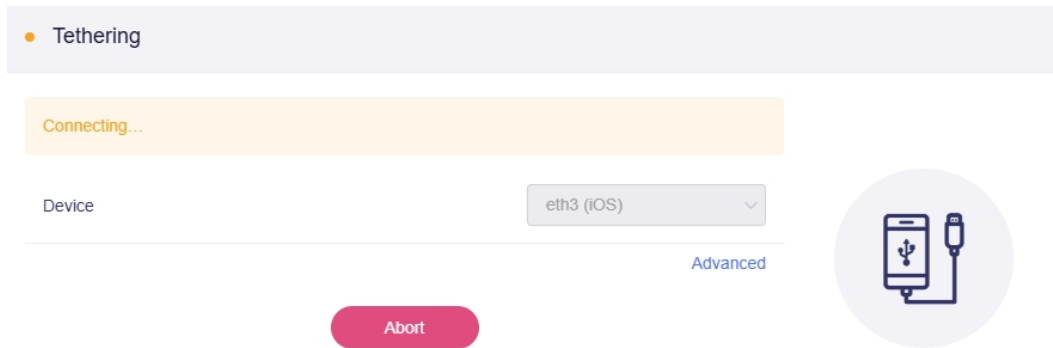

Once connected, this page will display the Tethering connection details.

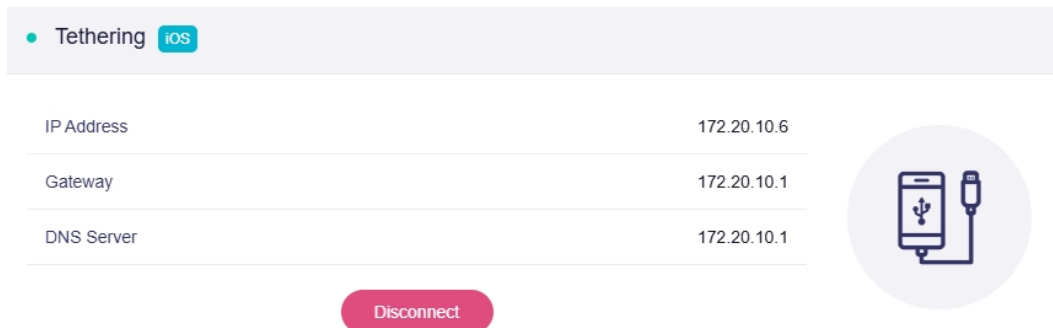

Android Tethering

1. Connect an Android phone to the router's USB port using a USB cable. A system dialog may appear asking USB preferences. Select **USB Tethering** or **File Transfer** if prompted.

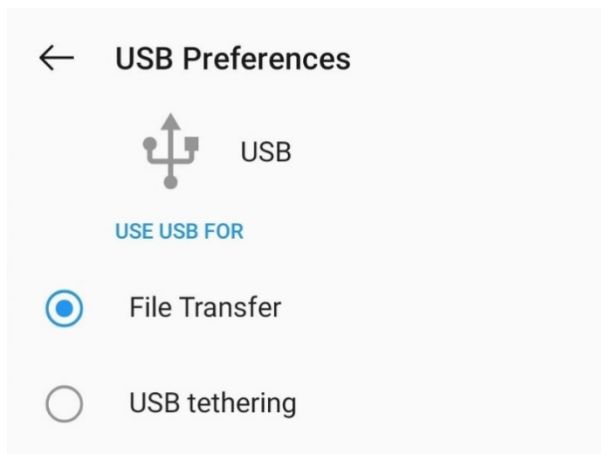

2. Go to your phone's **Settings > Network & Internet > Personal Hotspot**. Enable **Personal Hotspot** or **USB Tethering**.

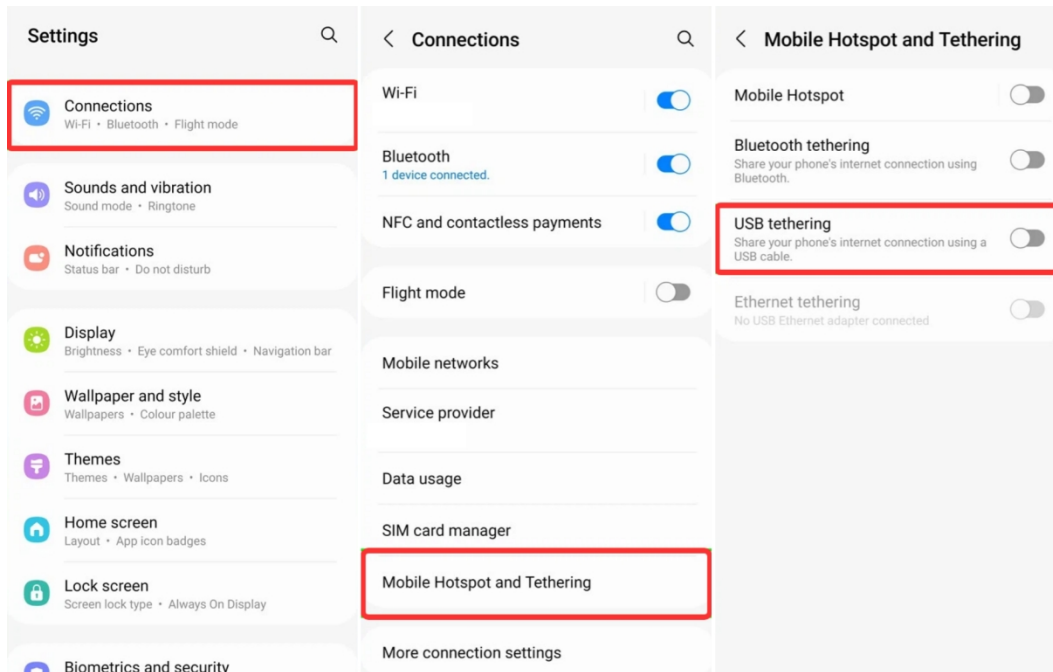

(The steps to enable USB Tethering vary by brand. Check your device's settings for the exact location, and contact your manufacturer's support if needed.)

3. Connect a computer or another phone to the router, then log in to the router's web admin panel, navigate to **INTERNET > Tethering**. Click **Connect**.

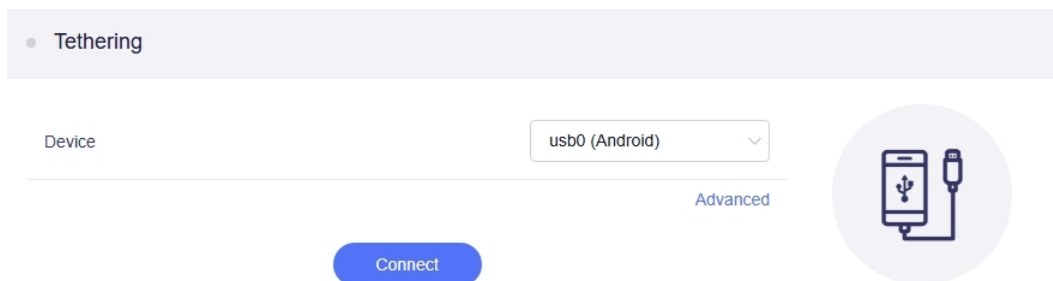

If you need to set advanced settings such as TTL, HL, and MTU, click **Advanced** to customize these settings before clicking **Connect**.

● Tethering

Device	usb0 (Android) ▾
TTL ⓘ	Optional
HL ⓘ	Optional
MTU ⓘ	1500

Connect



4. It will start connecting. Once connected, this page will display the Tethering connection status.

● Tethering **Android**

IP Address	192.168.11.9
Gateway	192.168.11.1
DNS Server	192.168.11.1

Disconnect



Troubleshooting

If the Tethering connection fails, try these troubleshooting steps:

- Use the original power supply for the router.
- Unplug and re-plug the USB cable.
- Use another USB cable. Ensure it supports data transfer (not just charging).
- Turn off and turn on "USB Tethering" for a few times (for Android Phone).
- Turn off and turn on "Allow Others to Join" for a few times (for iPhone).
- Restart your smartphone and try again.

If problem persists, contact our technical support at support@gl-inet.com.

4.2.4 Connect to the Internet via USB Modem

Connect the router to the internet by inserting a cellular-enabled USB modem into its USB port. This allows the router to connect to the Internet via 4G/5G networks, providing connectivity without relying on fixed-line broadband. It is suitable for in-vehicle use or outdoor activities. Note that this connection is implemented through the router's Tethering or Cellular interface.

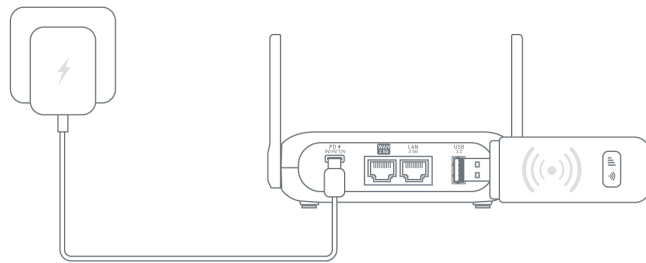

Follow the steps below to connect your router to the Internet via a USB modem.

1. Plug a USB modem with a pre-installed SIM card into the router's USB port before powering it on.
2. Log in to the router's web admin panel, navigate to **INTERNET > Tethering**, then click **Connect**.

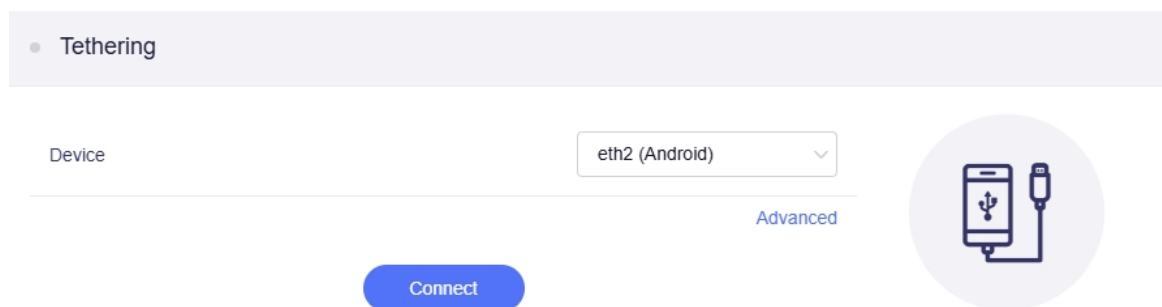

If you need to set advanced settings, such as TTL, HL, and MTU, click **Advanced** to customize these settings, then click **Connect**.

● Tethering

Device

TTL ⓘ

HL ⓘ

MTU ⓘ



3. It will start connecting. Once connected, this page will display the network details.

● Tethering Android

IP Address 192.168.1.100

Gateway 192.168.1.1

DNS Server 192.168.1.1, 192.168.1.1



Tips:

1. After initial setup, if you restart the router with the USB modem still connected, or re-insert the modem into the router, the USB modem will be automatically recognized, and a network connection will establish without re-clicking "Connect".
2. If you unplug the USB modem, the page will display the status shown below, indicating "No Tethering device found", while the Tethering interface will remain in the "Connecting" state.

● Tethering

Connecting...

 No Tethering device found. Plug in your smartphone or USB Modem to start.

Chapter 5

Wireless

This chapter guides you to check Wi-Fi status and configure wireless settings.

5.1 Wi-Fi Status Display

The router's Wi-Fi networks are enabled by default, and the corresponding Wi-Fi icon will light up below the device model image on the INTERNET page.



If the cursor hovers over the enabled Wi-Fi icon, a Wi-Fi QR code will be displayed as follows. You can scan the Wi-Fi QR code to quickly connect to the corresponding Wi-Fi.



5.2 Wireless Settings

Log in to the router's web admin panel and navigate to **WIRELESS**.

The wireless page displays the router's 2.4GHz, 5GHz, and MLO Wi-Fi settings, with each further divided into main Wi-Fi and guest Wi-Fi networks for flexible management.

5.2.1 MLO Wi-Fi

MLO (Multi-Link Operation) is one of the core features of Wi-Fi 7 (802.11be), designed to improve network performance, significantly reduce latency, and enhance connection stability by utilizing multiple frequency bands simultaneously.

The MLO Main Wi-Fi allows you to configure multiple settings, including enabling/disabling Wi-Fi, enabling/disabling randomized BSSID, setting the Wi-Fi name (SSID), security, password, and SSID visibility.

MLO Wi-Fi MLO Guest Wi-Fi

i Wi-Fi 7 clients are recommended to connect with MLO Wi-Fi, which can greatly improve the network transmission rate and reliability through multi-band connection.

Enable Wi-Fi

Wi-Fi Name (SSID)

Enable Randomized BSSID

Wi-Fi Security

Wi-Fi Password

SSID Visibility

The MLO Guest Wi-Fi allows you to configure simplified settings, including enabling/disabling Wi-Fi, setting the Wi-Fi name (SSID), security, password, and SSID visibility.

MLO Wi-Fi MLO Guest Wi-Fi

Wi-Fi 7 clients are recommended to connect with MLO Wi-Fi, which can greatly improve the network transmission rate and reliability through multi-band connection.

Enable Wi-Fi OFF

Wi-Fi Name (SSID) GL-MT3600BE-122-MLO-G

Wi-Fi Security ⓘ WPA2-PSK/WPA3-SAE

Wi-Fi Password

SSID Visibility Shown

Modify

5.2.2 5GHz Wi-Fi

The 5GHz Main Wi-Fi allows you to configure multiple settings, including enabling/disabling Wi-Fi, setting TX power, enabling/disabling randomized BSSID, setting Wi-Fi name (SSID), security, password, SSID visibility, mode, bandwidth, and channel.

● 5 GHz Wi-Fi ● 5 GHz Guest Wi-Fi

Enable Wi-Fi ON

TX Power Max

Wi-Fi Name (SSID) GL-MT3600BE-122-5G

Enable Randomized BSSID ON

Wi-Fi Security WPA2-PSK/WPA3-SAE

Wi-Fi Password

SSID Visibility Shown

Wi-Fi Mode 11a/n/ac/ax/be

Bandwidth 80 MHz

Channel Auto

Modify

Note:

1. **Randomized BSSID** is enabled by default. It aims to prevent the client vendors from collecting nearby Wi-Fi BSSIDs and client devices' GPS coordinates to their servers.
2. The **Bandwidth** and **Channel** cannot be modified when the router is configured as a repeater, as they follow that of the repeated network.
3. When **Channel** is set to **Auto**, the router's Wi-Fi will not automatically switch to the DFS channel.

- When the **Bandwidth** is set to **160 MHz** (available on selected models only), the Wi-Fi will always use the DFS channel, even if you select a non-DFS channel or set it to Auto.

The 5GHz Guest Wi-Fi allows you to configure simplified settings, including enabling/disabling Wi-Fi, setting Wi-Fi name (SSID), security, password, and SSID visibility.

5 GHz Wi-Fi 5 GHz Guest Wi-Fi

Enable Wi-Fi OFF

Wi-Fi Name (SSID) GL-MT3600BE-122-5G-Gu

Wi-Fi Security WPA2-PSK/WPA3-SAE ▾

Wi-Fi Password

SSID Visibility Shown ▾

[Modify](#)

5.2.3 2.4GHz Wi-Fi

The 2.4GHz Main Wi-Fi allows you to configure multiple settings, including enabling/disabling Wi-Fi, setting TX power, enabling/disabling randomized BSSID, setting Wi-Fi name (SSID), security, password, SSID visibility, mode, bandwidth, and channel.

● 2.4 GHz Wi-Fi ● 2.4 GHz Guest Wi-Fi

Enable Wi-Fi

TX Power Max

Wi-Fi Name (SSID) GL-MT3600BE-122

Enable Randomized BSSID

Wi-Fi Security WPA2-PSK

Wi-Fi Password

SSID Visibility Shown

Wi-Fi Mode 11b/g/n/ax/be

Bandwidth 20/40 MHz

Channel Auto

Modify

Note:

1. **Randomized BSSID** is enabled by default. It aims to prevent the client vendors from collecting nearby Wi-Fi BSSIDs and client devices' GPS coordinates to their servers.
2. The **Bandwidth** and **Channel** cannot be modified when the router is configured as a repeater, as they follow that of the repeated network.
3. When **Channel** is set to **Auto**, the router's Wi-Fi will not automatically switch to the DFS channel.

The 2.4GHz Guest Wi-Fi allows you to configure simplified settings, including enabling/disabling Wi-Fi, setting Wi-Fi name (SSID), security, password, and SSID visibility.

● 2.4 GHz Wi-Fi ● 2.4 GHz Guest Wi-Fi

Enable Wi-Fi OFF

Wi-Fi Name (SSID) GL-MT3600BE-122-Guest

Wi-Fi Security WPA2-PSK

Wi-Fi Password

SSID Visibility Shown

Modify

5.2.4 Randomized BSSID

Randomized BSSID feature has been available since firmware v4.6. It aims to prevent the client vendors from collecting nearby Wi-Fi BSSIDs and client devices' GPS coordinates to their servers.

How Client Vendors Collect Location Data

Client vendors usually collect the geographical location data of Wi-Fi access points by leveraging their unique BSSIDs to locate devices. When client devices (e.g., mobile phones, computers) scan or connect to a router:

- If other devices are within the router's Wi-Fi signal coverage, their location and movement trajectories may be exposed.
- If a device uses GPS for positioning, it periodically uploads nearby Wi-Fi BSSIDs and corresponding GPS coordinates to the vendor's server.

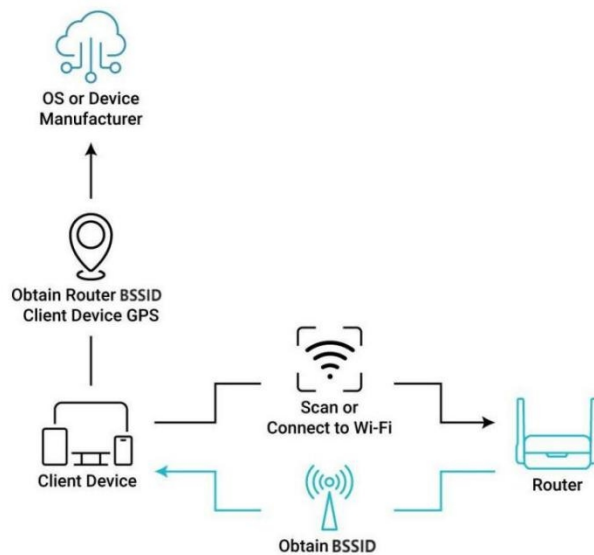

Security Risks of Crowdsourced Tracking

Even devices without GPS (or with GPS disabled) can estimate their location by querying visible BSSID info. However, this crowd-sourced location tracking system has security vulnerabilities. Attackers can use it to accumulate a global database of Wi-Fi access point locations and continuously track the movement trajectories of devices, posing a threat to user privacy and security.

How Randomized BSSID Protects Your Privacy

To address these vulnerabilities, GL.iNet routers implement the Randomized BSSID feature as a privacy safeguard.

In the router's web admin panel, go to **WIRELESS** -> **5GHz Wi-Fi** or **2.4GHz Wi-Fi**, the BSSID option is enabled by default. With this setting, the device uses a randomly generated BSSID and renews it each time it boots. If you disable the random BSSID, the router reverts to using the real MAC address.

Note: For Guest Wi-Fi, the BSSID remains consistent with the Main Wi-Fi BSSID within the same frequency band.

Chapter 6

Clients

This chapter guides you to view details of connected devices and manage their connections.

Log in to the router's web admin panel and navigate to **CLIENTS**.

The Clients page displays information about connected devices, including device name, connection type, IP and MAC address, speed, and traffic, arranged left to right. It also provides quick access to reserve IP, block client or perform other actions.

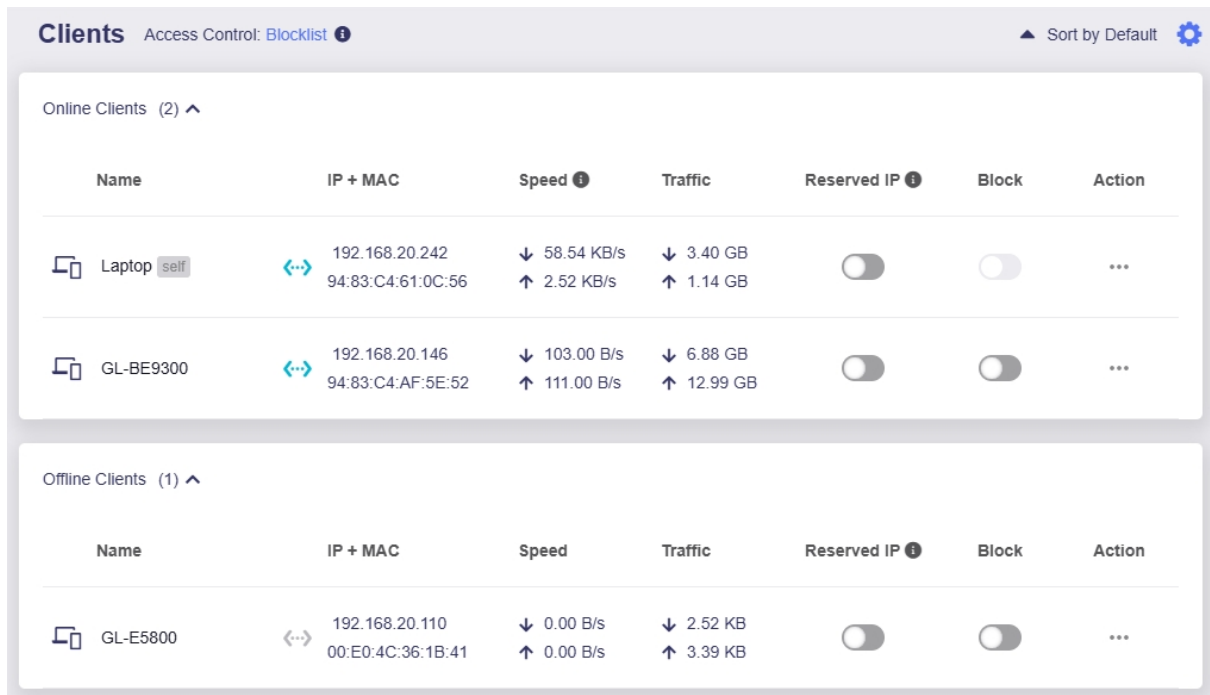

The screenshot shows the 'Clients' page in a router's web admin panel. The page title is 'Clients' with a sub-header 'Access Control: Blocklist'. There are two sections: 'Online Clients (2)' and 'Offline Clients (1)'. Each section contains a table with columns for Name, IP + MAC, Speed, Traffic, Reserved IP, Block, and Action.

Online Clients (2) ^						
Name	IP + MAC	Speed	Traffic	Reserved IP	Block	Action
Laptop self	192.168.20.242 94:83:C4:61:0C:56	↓ 58.54 KB/s ↑ 2.52 KB/s	↓ 3.40 GB ↑ 1.14 GB	<input type="checkbox"/>	<input type="checkbox"/>	...
GL-BE9300	192.168.20.146 94:83:C4:AF:5E:52	↓ 103.00 B/s ↑ 111.00 B/s	↓ 6.88 GB ↑ 12.99 GB	<input type="checkbox"/>	<input checked="" type="checkbox"/>	...

Offline Clients (1) ^						
Name	IP + MAC	Speed	Traffic	Reserved IP	Block	Action
GL-E5800	192.168.20.110 00:E0:4C:36:1B:41	↓ 0.00 B/s ↑ 0.00 B/s	↓ 2.52 KB ↑ 3.39 KB	<input type="checkbox"/>	<input checked="" type="checkbox"/>	...

- **Online Clients:** It refers to devices currently connected to the router's network.
- **Offline Clients:** It refers to devices that have previously connected to the router but are now disconnected from the network.

6.1 Device Details

Name	IP + MAC	Speed	Traffic	Reserved IP	Block	Action
Laptop <small>self</small>	192.168.20.242 94:83:C4:61:0C:56	↓ 7.54 KB/s ↑ 1.74 KB/s	↓ 3.60 GB ↑ 1.17 GB	<input type="checkbox"/>	<input type="checkbox"/>	...
GL-BE9300	192.168.20.146 94:83:C4:AF:5E:52	↓ 200.00 B/s ↑ 179.00 B/s	↓ 7.17 GB ↑ 13.84 GB	<input type="checkbox"/>	<input type="checkbox"/>	...

1. Device Name

The first column displays the device name and type, which depends on the hostname of the device operator. The blue icon next to the device name represents the connection method, indicating that the device is connected to the router via an Ethernet cable.

2. IP and MAC Address

The second column lists the IP and MAC addresses of the connected device. If the connected devices use randomized MAC addresses, a prompt will appear, indicating that this is a randomized MAC address.



If the second character of the MAC address is 2, 6, A or E (Ignore case), it is considered as a randomized MAC address. However, some devices may use a different rule to generate a randomized MAC address, so this detection method may not be accurate.

3. Speed

The third column displays the internet speed of the connected device. This speed represents the average speed over the past 3 minutes. The system starts calculating the average speed when this page is opened (e.g., if the page has only been open for 10 seconds, the average speed will be based on just 10 seconds of data).

4. **Traffic:** The fourth column displays the internet traffic of the connected device.

5. Reserve IP

In the fifth column, you can reserve IP address for connected device with one click. When you specify a reserved IP address for a client within the local area network, it will always receive the same IP address each time it connects to the router.

6. Blocklist

In the sixth column, you can block specific connected devices with one click.

The Access Control rule is Blocklist by default, and you can switch it to Allowlist from the top as needed.

The screenshot shows the 'Clients' page in a router's web interface. At the top, there's a header 'Clients' with a sub-header 'Access Control: Blocklist' highlighted by a red box. To the right, there are options for 'Sort by Default' and a settings gear icon. Below the header, it says 'Online Clients (2) ^'. A table lists two online clients:

Name	IP + MAC	Speed	Traffic	Reserved IP	Block	Action
Laptop <small>Self</small>	192.168.20.242 94:83:C4:61:0C:56	↓ 6.70 KB/s ↑ 2.09 KB/s	↓ 3.37 GB ↑ 1.14 GB	<input type="checkbox"/>	<input type="checkbox"/>	...
GL-BE9300	192.168.20.146 94:83:C4:AF:5E:52	↓ 109.00 B/s ↑ 112.00 B/s	↓ 6.88 GB ↑ 12.99 GB	<input type="checkbox"/>	<input type="checkbox"/>	...

Below the table, there's a section titled 'Access Control'. It has a 'Mode' dropdown menu currently set to 'Blocklist'. A dropdown menu is open, showing 'Blocklist' (highlighted in blue) and 'Allowlist'. Below the mode selection, there's a 'Self MAC' field with a value '1' and an example 'e.g. 11:22:33:44:55:66'.

- **Blocklist:** Devices with MAC addresses in the blacklist are not allowed to connect to this router. Please note that blocking client is based on the MAC address of the device. If the blocked device uses different MAC address next time, it can still be able to connect to router.
- **Allowlist:** Only devices with specific MAC addresses are allowed to connect to this router, suitable for IoT devices and enterprise network management.

6.2 Action

1. View Details

Click the three-dot icon in the **Action** column, and click **View Details** from the drop-down menu to view the device details on a single page.

The screenshot shows the 'Clients' management interface. At the top, it says 'Clients' and 'Access Control: Blocklist'. There is a 'Sort by Default' button with a gear icon. Below this is a section for 'Online Clients (2)'. A table lists two clients: 'Laptop' and 'GL-BE9300'. The table columns are Name, IP + MAC, Speed, Traffic, Reserved IP, Block, and Action. For the 'Laptop' client, the Action column has a three-dot menu open, with 'View Details' highlighted in a red box. Other options in the menu are 'Modify' and 'Limit Speed'.

Name	IP + MAC	Speed	Traffic	Reserved IP	Block	Action
Laptop	192.168.20.242 94:83:C4:61:0C:56	↓ 52.29 KB/s ↑ 5.27 KB/s	↓ 3.42 GB ↑ 1.14 GB	<input type="checkbox"/>	<input type="checkbox"/>	⋮ View Details Modify Limit Speed
GL-BE9300	192.168.20.146 94:83:C4:AF:5E:52	↓ 144.96 KB/s ↑ 101.17 KB/s	↓ 7.00 GB ↑ 13.03 GB	<input type="checkbox"/>	<input type="checkbox"/>	

The screenshot shows the 'Client Details' page for the 'Laptop' client. The page title is 'Clients / Client Details'. Below the title, there is a section for 'Laptop' with a 'self' tag. The details are presented in a key-value format:

Hostname	GL-AXT1800
Connection Method	Ethernet
MAC	94:83:C4:61:0C:56
Speed	↓ 5.58 KB/s ↑ 1.24 KB/s
Traffic	↓ 3.42 GB ↑ 1.14 GB
Reserved IP	OFF
Block	OFF
IP Address	192.168.20.242

2. Modify

Click the three-dot icon in the **Action** column, and click **Modify** from the drop-down menu to modify the device name and type.

Clients Access Control: Blocklist Sort by Default

Online Clients (2) ^

Name	IP + MAC	Speed	Traffic	Reserved IP	Block	Action
Laptop <small>self</small>	192.168.20.242 94:83:C4:61:0C:56	↓ 5.48 KB/s ↑ 1.14 KB/s	↓ 3.42 GB ↑ 1.14 GB	<input type="checkbox"/>	<input type="checkbox"/>	⋮
GL-BE9300	192.168.20.146 94:83:C4:AF:5E:52	↓ 17.39 KB/s ↑ 13.84 KB/s	↓ 7.03 GB ↑ 13.07 GB	<input type="checkbox"/>	<input type="checkbox"/>	⋮

- View Details
- Modify**
- Limit Speed

Modify Client Device

Name

Auto

Device Type

Optional ^

- Desktop
- Phone
- Tablet PC
- Camera
- Wearable device
- Laptop
- Printer

Cancel

3. Limit Speed

Click the three-dot icon in the **Action** column, and click **Limit Speed** from the drop-down menu.

The screenshot shows the 'Clients' interface with the following data:

Name	IP + MAC	Speed	Traffic	Reserved IP	Block	Action
Laptop <small>self</small>	192.168.20.242 94:83:C4:61:0C:56	↓ 80.17 KB/s ↑ 2.72 KB/s	↓ 3.44 GB ↑ 1.15 GB	<input type="checkbox"/>	<input type="checkbox"/>	⋮
GL-BE9300	192.168.20.146 94:83:C4:AF:5E:52	↓ 5.05 KB/s ↑ 12.38 KB/s	↓ 7.03 GB ↑ 13.10 GB	<input type="checkbox"/>	<input type="checkbox"/>	⋮

The dropdown menu for the 'GL-BE9300' client is open, showing options: View Details, Modify, and Limit Speed (highlighted with a red box).

You will be able to limit the speed of a connected device, with the unit set to KB/s.

The 'Limit Speed Settings' dialog box contains the following information:

- Download: KB/s
- Upload: KB/s
- Buttons: Cancel, Apply

If speed limitation has been applied to a device, the upload/download speed arrows will turn yellow.

The screenshot shows the 'Clients' interface with the following data:

Name	IP + MAC	Speed	Traffic	Reserved IP	Block	Action
Laptop <small>self</small>	192.168.20.242 94:83:C4:61:0C:56	↓ 8.73 KB/s ↑ 3.92 KB/s	↓ 3.44 GB ↑ 1.15 GB	<input type="checkbox"/>	<input type="checkbox"/>	⋮
GL-BE9300	192.168.20.146 94:83:C4:AF:5E:52	↓ 5.04 KB/s ↑ 20.27 KB/s	↓ 7.03 GB ↑ 13.10 GB	<input type="checkbox"/>	<input type="checkbox"/>	⋮







The 'Speed' column for the 'GL-BE9300' client now shows yellow arrows, indicating that speed limitation has been applied. The 'Limit Speed' option in the previous screenshot is highlighted with a red box.

Tip: If the Limit Speed option is not visible, go to **NETWORK > Network Acceleration** and disable it. The Limit Speed option will then become available.

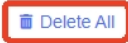
6.3 Remove Clients







In the **Offline Clients** section, you can click **Delete All** in the top right corner to delete all offline clients.





Offline Clients (5) ^ Delete All

Name	IP + MAC	Speed	Traffic	Reserved IP ⓘ	Block	Action
 glkvm	 192.168.8.117 94:83:C4:B7:20:01	↓ 0.00 B/s ↑ 0.00 B/s	↓ 104.06 MB ↑ 119.73 MB	<input type="checkbox"/>	<input type="checkbox"/>	...
 iPhone	 192.168.8.129 FE:84:B8:54:1B:8A ⓘ	↓ 0.00 B/s ↑ 0.00 B/s	↓ 51.94 MB ↑ 482.53 KB	<input type="checkbox"/>	<input type="checkbox"/>	...
 Unknown	 192.168.8.168 BA:0A:6E:DC:7C:BE ⓘ	↓ 0.00 B/s ↑ 0.00 B/s	↓ 0.00 B ↑ 10.11 KB	<input type="checkbox"/>	<input type="checkbox"/>	...

If you want to remove a specific client, click the three-dot icon in the **Action** column, then click **Remove Client** from the drop-down menu.

Offline Clients (5) ^ Delete All

Name	IP + MAC	Speed	Traffic	Reserved IP ⓘ	Block	Action
 glkvm	 192.168.8.117 94:83:C4:B7:20:01	↓ 0.00 B/s ↑ 0.00 B/s	↓ 104.06 MB ↑ 119.73 MB	<input type="checkbox"/>	<input type="checkbox"/>	...
 iPhone	 192.168.8.129 FE:84:B8:54:1B:8A ⓘ	↓ 0.00 B/s ↑ 0.00 B/s	↓ 51.94 MB ↑ 482.53 KB	<input type="checkbox"/>	<input type="checkbox"/>	...
 Unknown	 192.168.8.168 BA:0A:6E:DC:7C:BE ⓘ	↓ 0.00 B/s ↑ 0.00 B/s	↓ 0.00 B ↑ 10.11 KB	<input type="checkbox"/>	<input type="checkbox"/>	...

-  View Details
-  Modify
-  Limit Speed
-  Remove Client

6.4 Sort

You can set the device sorting rule for the Client page in the top right corner.

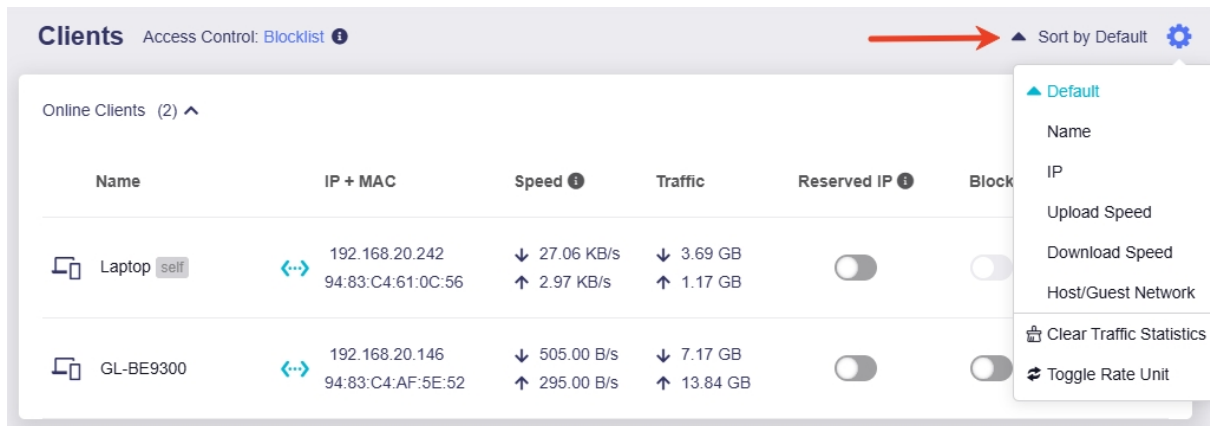

Online Clients (2) ^

Name	IP + MAC	Speed ⓘ	Traffic	Reserved IP ⓘ	Block
Laptop self	192.168.20.242 94:83:C4:61:0C:56	↓ 27.06 KB/s ↑ 2.97 KB/s	↓ 3.69 GB ↑ 1.17 GB	<input type="checkbox"/>	<input type="checkbox"/>
GL-BE9300	192.168.20.146 94:83:C4:AF:5E:52	↓ 505.00 B/s ↑ 295.00 B/s	↓ 7.17 GB ↑ 13.84 GB	<input type="checkbox"/>	<input type="checkbox"/>

The default sorting rules are as follows:

- The self device (i.e., the device used to access the router's web admin panel) is always listed first.
- In the **Online Clients** section, devices are listed higher if they connected earlier.
- In the **Offline Clients** section, devices are listed higher if they disconnected earlier.

Chapter 7

Cloud Services

This chapter introduces two cloud services: GoodCloud and AstroWarp.

7.1 GoodCloud

GL.iNet GoodCloud is a platform designed to simplify the remote deployment and management of connected devices. It provides an easy way to remotely access and manage GL.iNet routers. By centralizing network devices on the cloud, users can efficiently perform batch management tasks, such as deploying network configurations and performing software upgrades. They can also remotely access the router's web admin panel or connect to the router's terminal via SSH, achieving cross-regional and end-to-end network device management.

With GoodCloud, you can:

- Check your router's status in real-time
- Manage groups of routers
- Set up routers remotely
- Monitor connected clients
- Operate routers in batch
- Establish Site-to-Site connection

Some features are available in Enterprise Plan and VAR (Value Added Reseller) Plan. See [here](#) for details.

7.1.1 Enable GoodCloud

1. Log in to your router's web admin panel, navigate to **CLOUD SERVICE > GoodCloud**, and click **Get Started**.

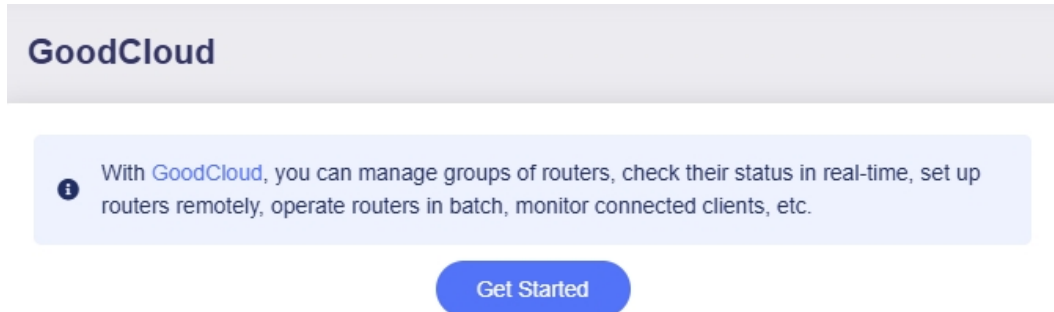

2. A drop-down window will appear in the upper right corner. Click **Enable**.

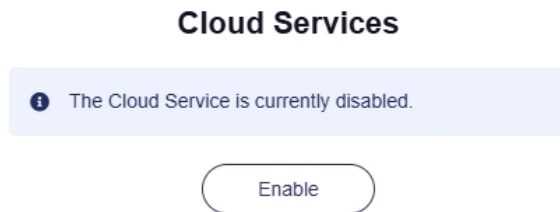

3. Log in with your GL.iNet Cloud account. If you don't have an account, sign up for one and log in. Once logged in, the router will be bound to your account automatically.

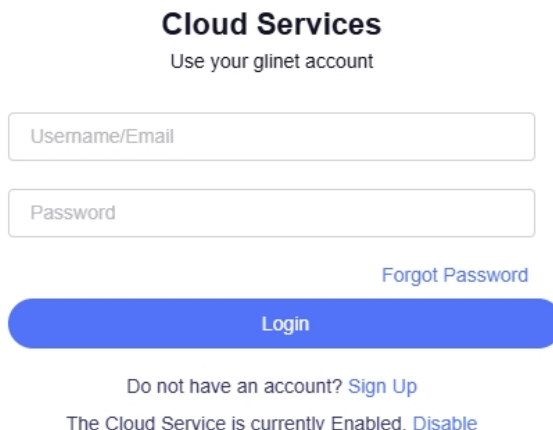

Tips:

- The GoodCloud binding steps differ by firmware version.
- If you fail to receive the verification email, check your spam folder or try again later.

For further assistance, contact us at support@gl-inet.com.

4. After binding successfully, click the **Cloud icon** in the upper right corner of the web admin panel. You will then see the bound device details, including the bound account, binding date, Device ID, Device MAC, and Device S/N.

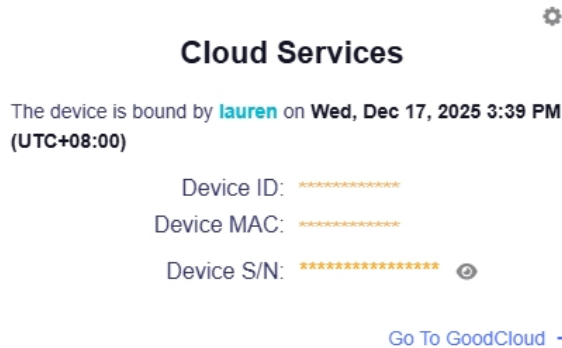

The screenshot shows the 'Cloud Services' section of a web admin panel. At the top right is a gear icon. The title 'Cloud Services' is centered. Below it, a message states: 'The device is bound by **lauren** on **Wed, Dec 17, 2025 3:39 PM (UTC+08:00)**'. Underneath, three fields are listed: 'Device ID: *****', 'Device MAC: *****', and 'Device S/N: *****' with a small eye icon to its right. At the bottom, there is a blue link 'Go To GoodCloud' with a right-pointing arrow.

5. Navigate to **CLOUD SERVICES > GoodCloud** and enable remote access. GoodCloud enables remote access to the bound router's web admin panel and terminal. This is particularly useful for remote management, network configuration, and troubleshooting. You can enable or disable the remote access for your router here.

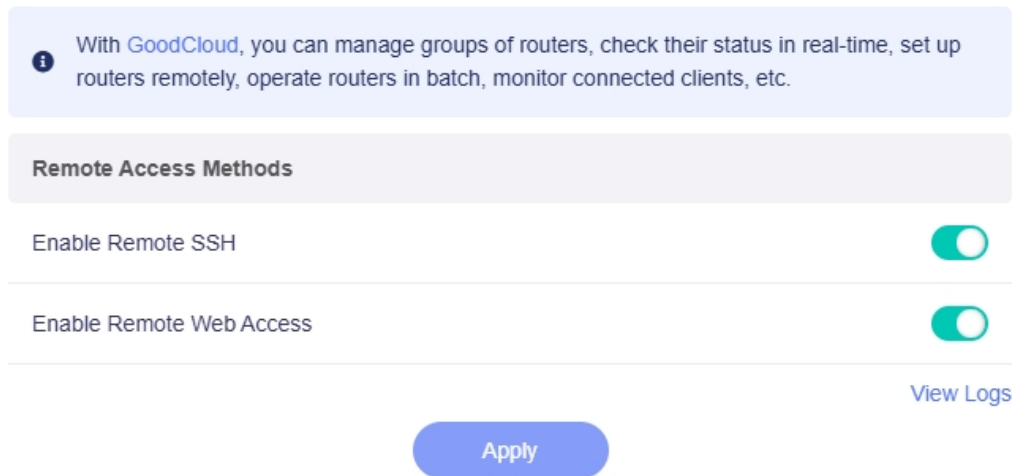

The screenshot shows the 'Remote Access Methods' configuration page. At the top, a light blue information box contains an 'i' icon and the text: 'With GoodCloud, you can manage groups of routers, check their status in real-time, set up routers remotely, operate routers in batch, monitor connected clients, etc.'. Below this is a section titled 'Remote Access Methods' with a light grey background. It contains two rows: 'Enable Remote SSH' with a green toggle switch turned on, and 'Enable Remote Web Access' with a green toggle switch turned on. At the bottom right, there is a blue link 'View Logs'. At the bottom center, there is a blue rounded button labeled 'Apply'.

- **Remote SSH:** Remotely access the router's terminal from GoodCloud using SSH.
- **Remote Web Access:** Remotely access to the router's web admin panel from GoodCloud via HTTP/HTTPS.
- **View Logs:** Redirect to the Log page and display Cloud log.

7.1.2 Manage Your Router

Check Device Details

Log in to the [GoodCloud](#) platform and navigate to **Device > Bound Devices**. You can view the device's basic information, such as host name, status (online/offline), model, firmware version, and MAC address.

<input type="text" value="Q Name / MAC / IP / SN / IMEI"/>	<input type="button" value="Filter"/>					
<hr/>						
<input type="checkbox"/>	Name	Status	Model	Version	MAC	IP
<input type="checkbox"/>	MT3600BE_122	Online	MT3600BE	4.8.7	94:83:C4:BE:E1:22	183.178.54.242

Click the device name to enter the device details page, which displays basic information, statistical data, network overview, client list, and timeline. You can also perform advanced operations, such as remotely accessing the router, and rebooting the device.

Bound Devices / Edit Device

MT3600BE_122

Basic Info

Update Time: 05-11 12:16:56

Status: Online

Type: Router

Model: MT3600BE

Firmware: 4.8.7

MAC Address: 94:83:C4:BE:E1:22

IP Address: 183.178.54.242

SN: 055a*****g994

Compile Time: 2026-04-15 14:02:39

Statistical Data

Update Time: 05-11 12:17:04

Network Latency

239.09 ms Latency, 9.21 ms Jitter, 0 % Packet Loss

Memory Usage

Up Time

0 days : 2 hrs : 28 mins

Ethernet1

Update Time: 05-11 12:16:58

Network Condition: Online

Status: Connected

Ethernet2

Update Time: 05-11 12:16:58

Network Condition: Offline

Status: Disconnected

Tethering

Update Time: 05-11 12:16:58

Status: Disconnected

Device List: [Details](#)

Repeater

Update Time: 05-11 12:16:58

Status: Not Connected

59

Remote Access Web

1. Log in to the router's web admin panel, navigate to **CLOUD SERVICES > GoodCloud**, enable **Remote Web Access**, then click **Apply**.

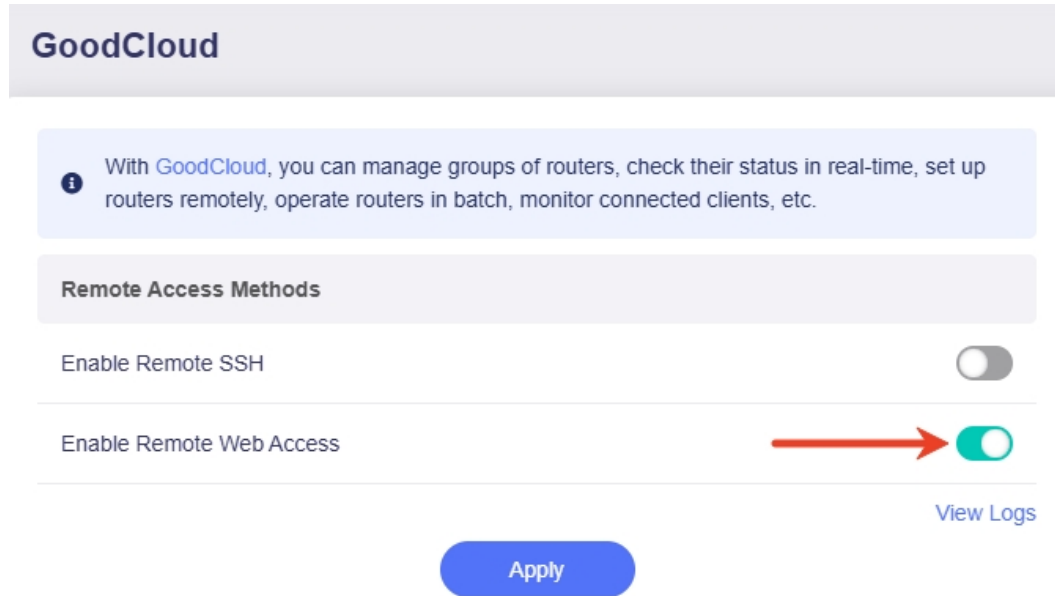

2. Log in to the [GoodCloud](#) platform and navigate to **Device > Bound Devices**. Click the device you want to access, and you will enter the device details page.
3. On the device details page, click the **Remote GUI** button in the upper right corner.

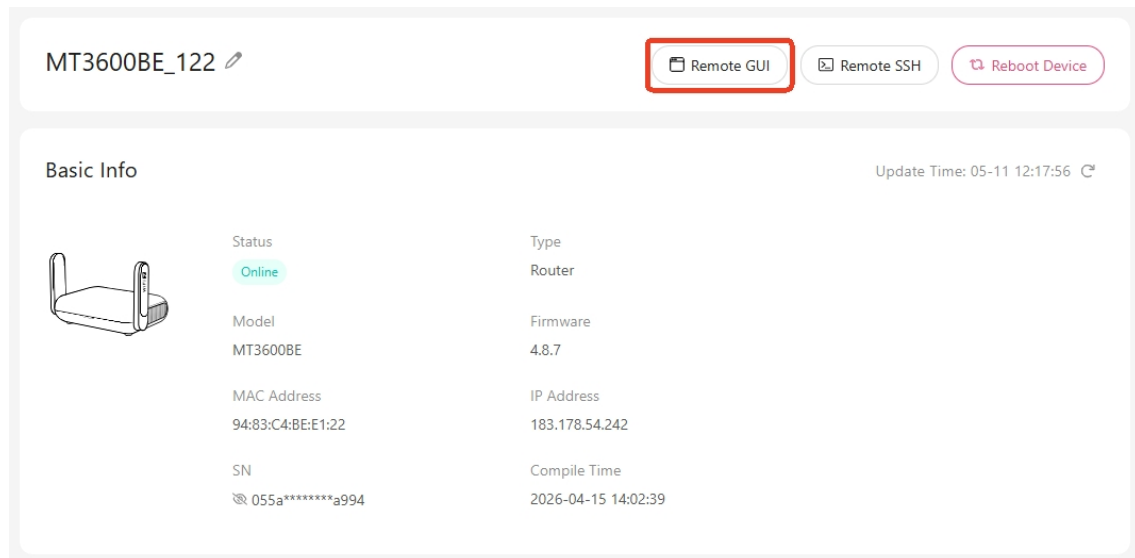

4. Select the transfer protocol and port. The defaults are **HTTP** and Port **80**. You can switch the protocol to HTTPS if needed, and the port will automatically change to 443. Then click **Apply**.

Remote GUI

HTTP HTTPS

* Port

80

Cancel

Apply

Remote GUI

HTTP HTTPS

* Port

443

Cancel

Apply

5. You will be re-directed to the router's login page. Enter the admin password to remotely access the router's web admin panel.

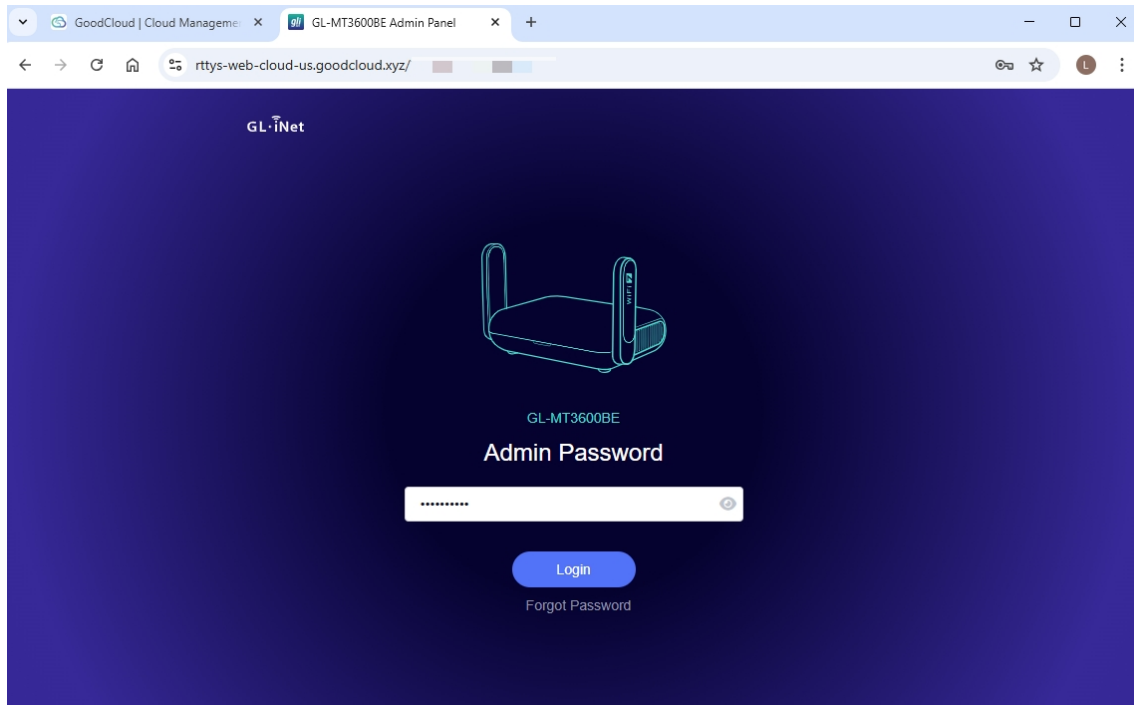

Remote Access Terminal

1. Log in to the router's web admin panel, navigate to **CLOUD SERVICES > GoodCloud**, enable **Remote SSH**, then click **Apply**.

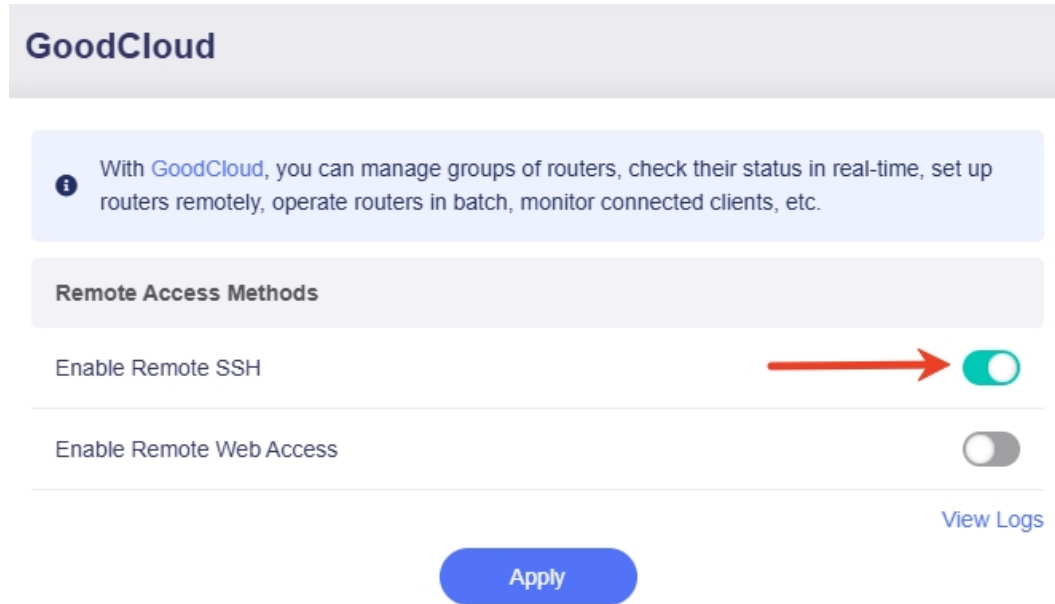

The screenshot shows the 'GoodCloud' configuration page. At the top, there is a header 'GoodCloud'. Below it is a light blue information box with an 'i' icon and text: 'With GoodCloud, you can manage groups of routers, check their status in real-time, set up routers remotely, operate routers in batch, monitor connected clients, etc.' Underneath is a section titled 'Remote Access Methods'. It contains two toggle switches: 'Enable Remote SSH' which is turned on (green) and has a red arrow pointing to it, and 'Enable Remote Web Access' which is turned off (grey). At the bottom right of this section is a 'View Logs' link. Below the 'Remote Access Methods' section is a large blue 'Apply' button.

2. Log in to the [GoodCloud](#) platform and navigate to **Device > Bound Devices**. Click the device you want to access, and you will enter the device details page.
3. On the device details page, click the **Remote SSH** button in the upper right corner.

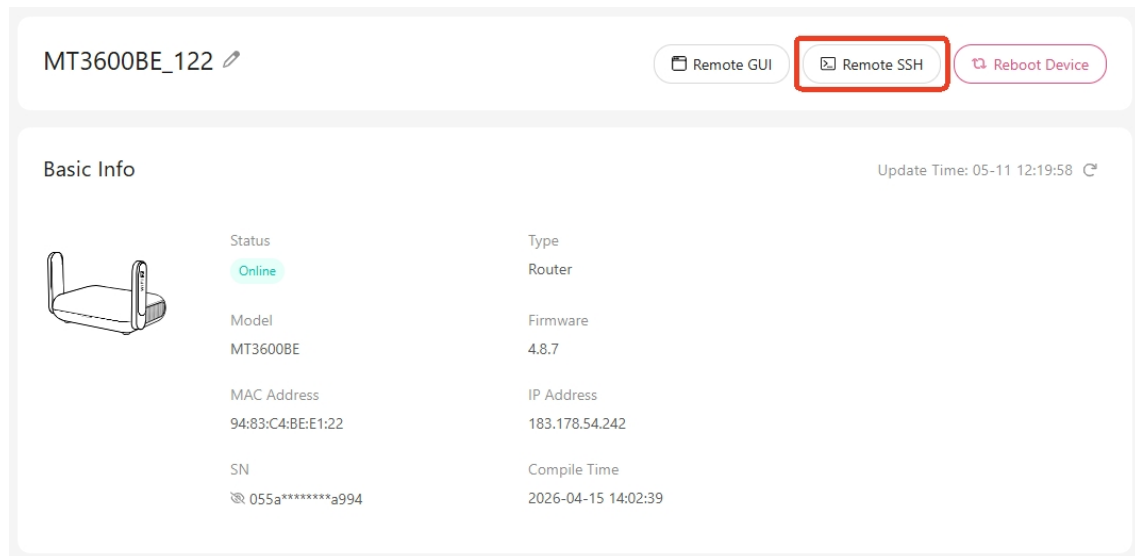

The screenshot shows the device details page for 'MT3600BE_122'. At the top right, there are three buttons: 'Remote GUI', 'Remote SSH' (which is highlighted with a red box), and 'Reboot Device'. Below the buttons is a 'Basic Info' section with a router icon on the left and a table of details on the right. The 'Update Time' is 05-11 12:19:58. The table contains the following information:

Status	Online	Type	Router
Model	MT3600BE	Firmware	4.8.7
MAC Address	94:83:C4:BE:E1:22	IP Address	183.178.54.242
SN	055a*****a994	Compile Time	2026-04-15 14:02:39

4. Log in as **root** and input the password to access the terminal of your router.

7.1.3 Unbind Device

In the router's web admin panel, click the Cloud icon in the upper right corner. In the drop-down menu, click the gear icon and select **Unbind**. Your device will then be unbound from your GoodCloud account.

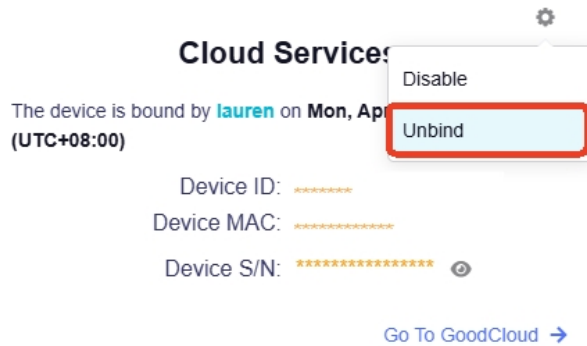

Alternatively, log in to the Cloud platform and navigate to **Device > Bound Devices**. Select the device you want to unbind, click **Settings** in the upper right corner, then select **Delete**. Your device will then be unbound from your GoodCloud account.

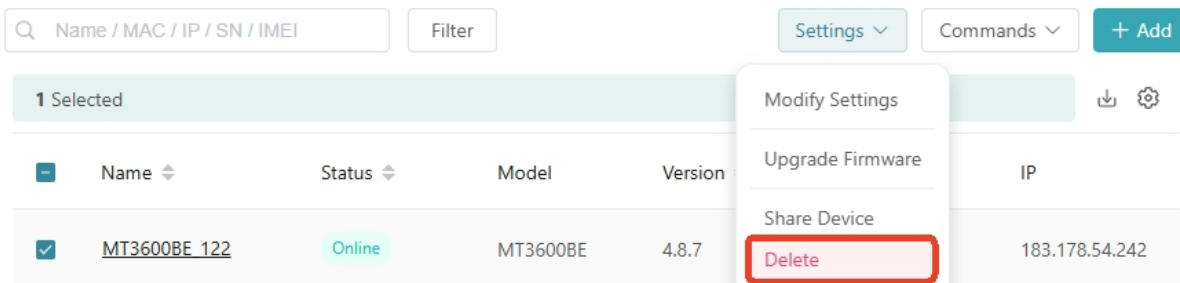

7.1.4 Disable GoodCloud

If you no longer want the device connected to the Cloud, click the Cloud icon in the upper right corner. In the drop-down menu, click the gear icon and select **Disable**.

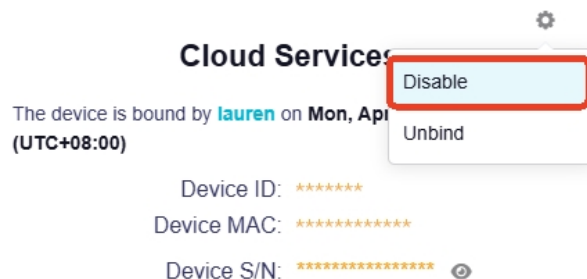

The Cloud service will then be disabled.

7.2 AstroWarp

AstroWarp is an advanced networking platform designed to provide seamless remote networking and remote device management.

Built specifically for GL.iNet router integration, AstroWarp supports comprehensive device management across entire networks, enabling both upper and lower device control.

With a focus on network-wide management and future support for hardware-level control, AstroWarp offers a more robust and dependable solution for managing devices and maintaining secure, stable networks.

Refer to astrowarp.net for more information.

Chapter 8

Get To Know VPN

This chapter introduces VPN concepts and common use scenarios.

8.1 Introduction

VPN

VPN, short for Virtual Private Network, establishes an encrypted and private tunnel between a device and a remote server, protecting data transmission and enabling secure access to private or restricted networks.

VPN Router

A VPN router features preinstalled VPN functionality, protecting all connected devices via VPN. Unlike setting up VPN on individual devices, configuring the router as a VPN client routes all traffic through an encrypted tunnel, with no separate setup needed per device. This secures multiple devices at once, saves time, and ensures consistent VPN configurations, reducing risks from improper individual settings.

GL.iNet routers support over 30 popular commercial OpenVPN and WireGuard VPN services. Upload your VPN configuration files to activate the VPN connection for secure networking. See [here](#) for the full list of third-party VPN providers.

OpenVPN

OpenVPN is an open-source VPN protocol using SSL/TLS-based security for point-to-site or site-to-site connections. It supports multiple encryption methods, TCP/UDP, and easy firewall/NAT bypass.

WireGuard

WireGuard is a lightweight, fast VPN protocol simpler and more efficient than OpenVPN. It features modern cryptography for efficiency, a small codebase for easier auditing and security, and state-of-the-art algorithms (ChaCha20/Poly1305) for encryption and data integrity.

8.2 Application Scenarios

1. Personal Data Privacy

The VPN service on this router works with a full range of wired and wireless devices, including laptops, tablets, smartphones, gaming consoles, and smart TVs. All your data transmitted over both wired and Wi-Fi connections is protected by the VPN. You can also customize VPN policies to enable flexible protection for specific devices.



2. Unrestricted Access Worldwide

Accessing some sites may be restricted by location. With VPN enabled, you can unblock any sites when necessary. By connecting to different third-party servers, you will be assigned different IP addresses for surfing or accessing region-blocked sites.

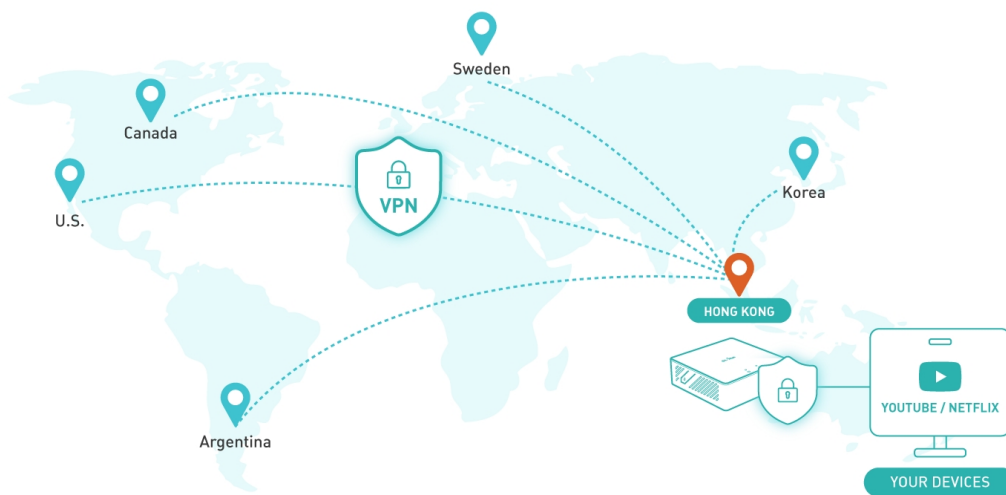

3. Small Business Data Security

Many people work in co-working spaces or cafes and rely on free public Wi-Fi. Such networks are vulnerable to cybercriminal attacks. By configuring your travel router as a VPN client, you can enjoy secure connectivity for work anywhere.

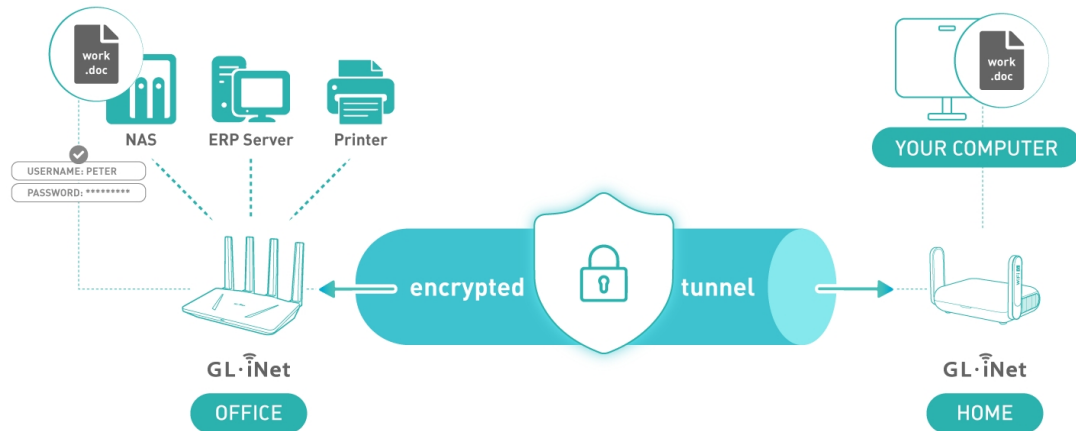

4. Secure Payment Infrastructure

Small retail owners need to handle customers' payment credentials when conducting on-site business. Using a VPN router, their POS machines can upload credit card information via an encrypted VPN tunnel to ensure payment security.

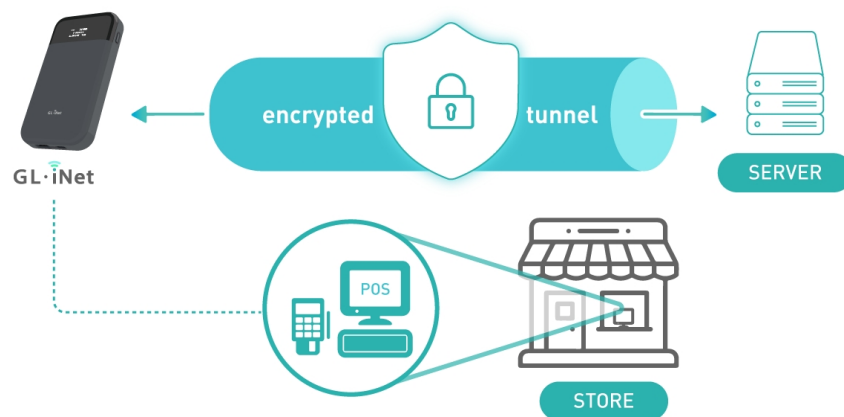

Chapter 9

VPN Dashboard

This chapter introduces how to manage VPN connections via the web admin panel.

Log in to the router's web admin panel and navigate to **VPN > VPN Dashboard**.

The VPN dashboard displays VPN connection details, such as tunnel rules, server address, traffic statistics, client virtual IP, and connection log, and allows users to configure advanced settings such as the VPN Kill Switch, IP Masquerading, and MTU. You can also activate multiple VPN connections for multi-tunnel scenarios.

9.1 VPN Setup Wizard

To begin with, click the book icon in the upper left corner and follow the VPN Setup Wizard to complete the VPN configuration quickly.

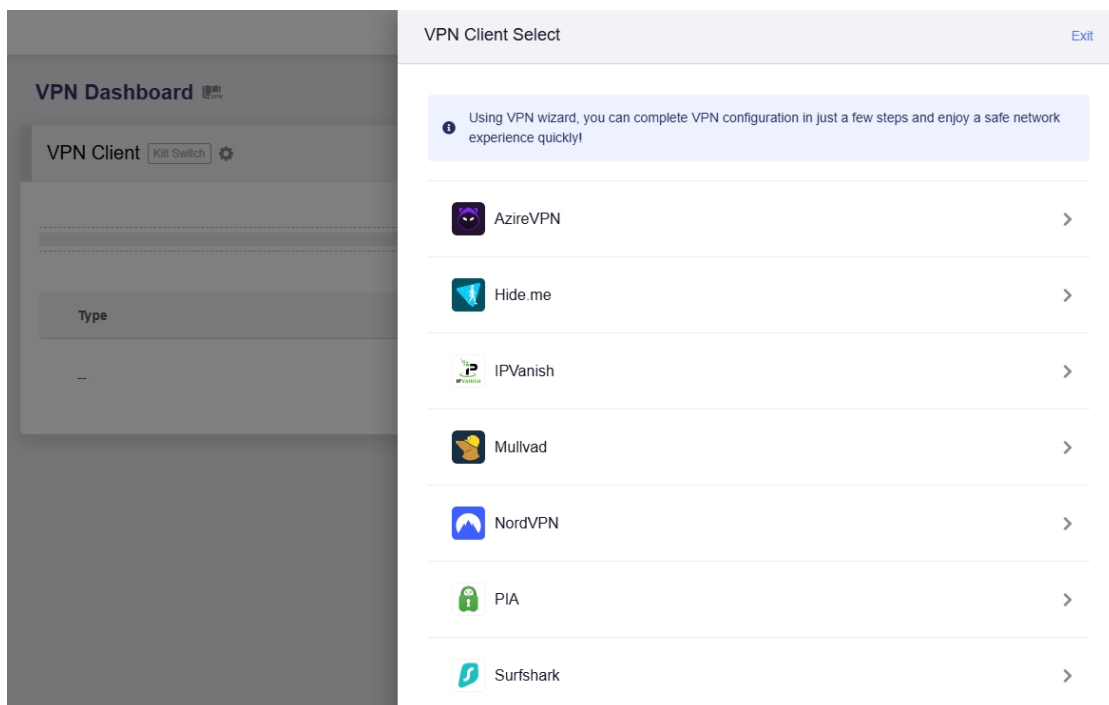
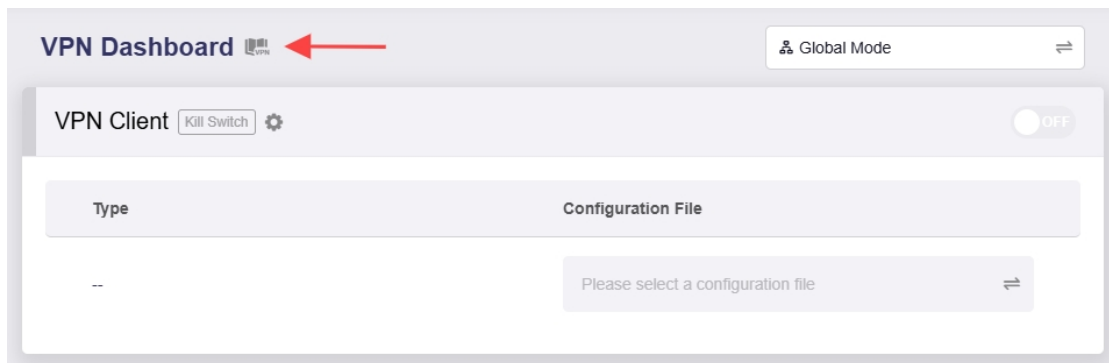

Note: The VPN Setup Wizard is only for the integrated VPN services, including AzireVPN, Hide.me, IPVanish, Mullvad, NordVPN, PIA and Surfshark. For other VPN providers, skip the wizard and go to **VPN > OpenVPN Client** or **WireGuard Client** to set up VPN manually.

Here's an example with **Hide.me**. Log in with Hide.me credentials.



Username

Password

Select a VPN server and click **Apply**. This is the server you will connect to, and your public IP address will appear to be from the selected server's location.

Server Address

<input type="radio"/> atlanta-v4.hideservers.net	<input type="radio"/> au-v4.hideservers.net
<input type="radio"/> bd-v4.hideservers.net	<input type="radio"/> be-v4.hideservers.net
<input type="radio"/> berlin-v4.hideservers.net	<input type="radio"/> bg-v4.hideservers.net
<input type="radio"/> bordeaux-v4.hideservers.net	<input checked="" type="radio"/> boston-v4.hideservers.net
<input type="radio"/> br-v4.hideservers.net	<input type="radio"/> ca-v4.hideservers.net
<input type="radio"/> calgary-v4.hideservers.net	<input type="radio"/> ch-v4.hideservers.net
<input type="radio"/> cl-v4.hideservers.net	<input type="radio"/> co-v4.hideservers.net

It will connect automatically. Once connected, go to the **VPN Dashboard**. You will see that a VPN tunnel has been enabled, displaying details including the VPN protocol (e.g., WireGuard), configuration file, server address, server listen port, traffic statistics, and the client virtual IP address. You can also view the connection logs in the lower right corner.

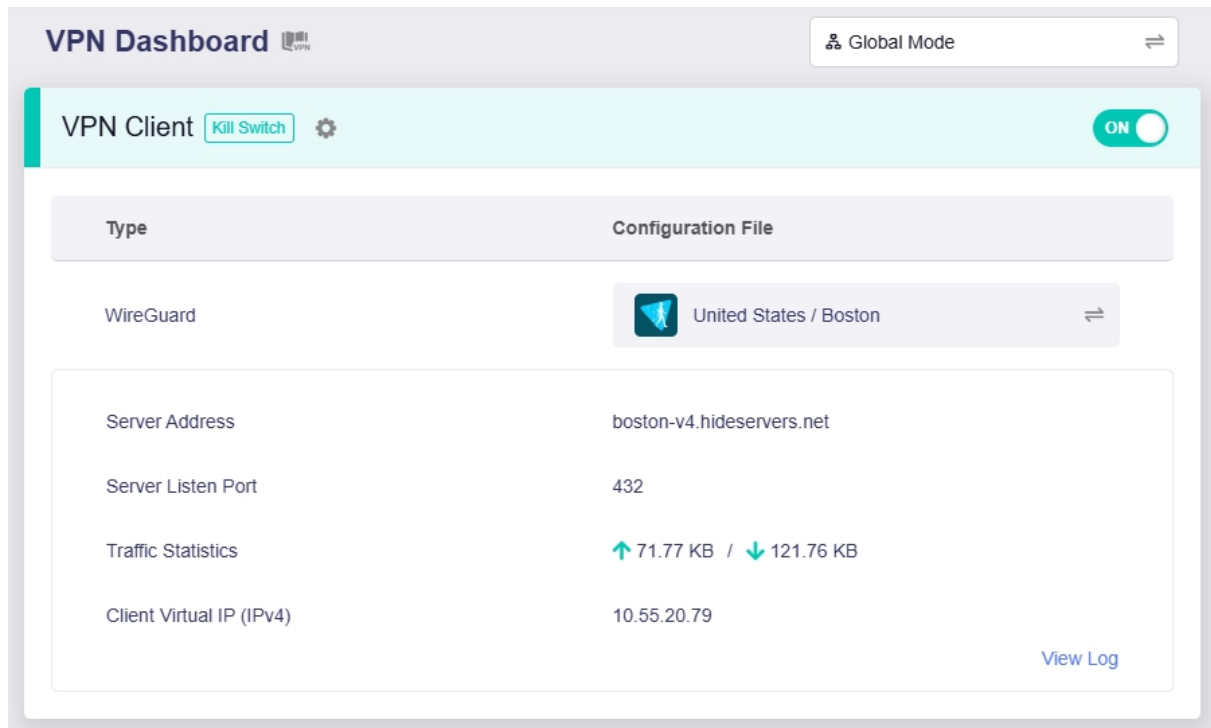

The screenshot displays the 'VPN Dashboard' interface. At the top left, it says 'VPN Dashboard' with a small VPN icon. On the top right, there is a 'Global Mode' button with a double-headed arrow icon. Below this is a 'VPN Client' section with a 'Kill Switch' button, a gear icon, and a toggle switch labeled 'ON'. The main content area is divided into two columns: 'Type' and 'Configuration File'. Under 'Type', it shows 'WireGuard'. Under 'Configuration File', it shows a server location 'United States / Boston' with a location pin icon and a double-headed arrow icon. Below this, there is a table of details:

Type	Configuration File
WireGuard	United States / Boston
Server Address	boston-v4.hideservers.net
Server Listen Port	432
Traffic Statistics	↑ 71.77 KB / ↓ 121.76 KB
Client Virtual IP (IPv4)	10.55.20.79

At the bottom right of the details section, there is a 'View Log' link.

9.2 VPN Mode

On the VPN Dashboard, click the button in the upper right corner to switch VPN modes if needed.

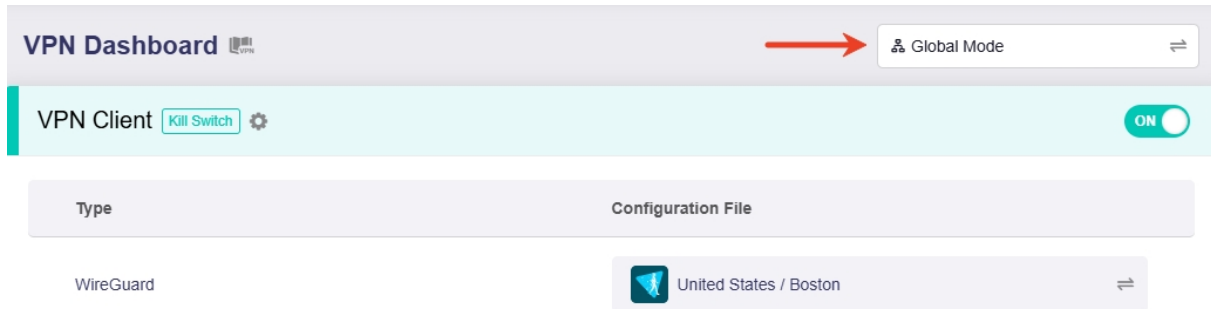

Two modes are available: **Global Mode** and **Policy Mode**.

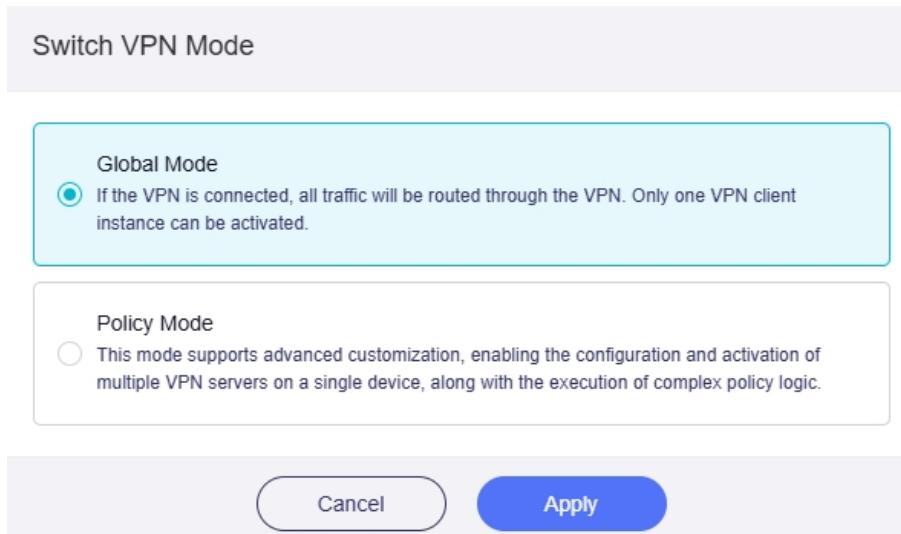

9.2.1 Global Mode

In this mode, all traffic will be routed through the VPN tunnel, and only one VPN client instance can be activated. It is ideal for scenarios requiring all device traffic to pass through a single VPN server, such as unified network security or region-specific content access.

In the following example, the router connects to an Australian server using the WireGuard protocol. All traffic from connected clients will be routed through this VPN tunnel.

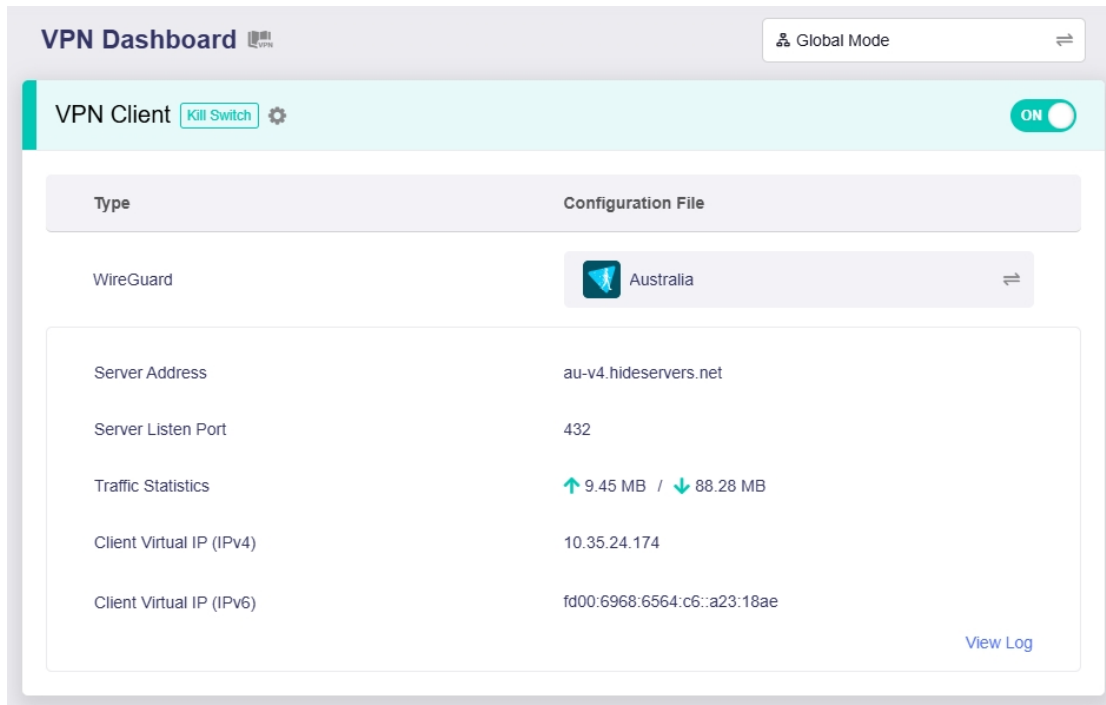

The screenshot shows the VPN Dashboard interface. At the top right, there is a dropdown menu set to "Global Mode". Below this, the "VPN Client" section is active, indicated by a green bar and a toggle switch labeled "ON". A "Kill Switch" button and a gear icon for settings are also visible. The main content area displays the configuration for a WireGuard client named "Australia".

Type	Configuration File
WireGuard	 Australia
Server Address	au-v4.hideservers.net
Server Listen Port	432
Traffic Statistics	↑ 9.45 MB / ↓ 88.28 MB
Client Virtual IP (IPv4)	10.35.24.174
Client Virtual IP (IPv6)	fd00:6968:6564:c6::a23:18ae

A "View Log" link is located at the bottom right of the configuration details.

Tunnel Options

You can configure advanced settings for your VPN tunnel, such as the VPN Kill Switch, IP Masquerading, and MTU. Click the gear icon in the upper right corner.

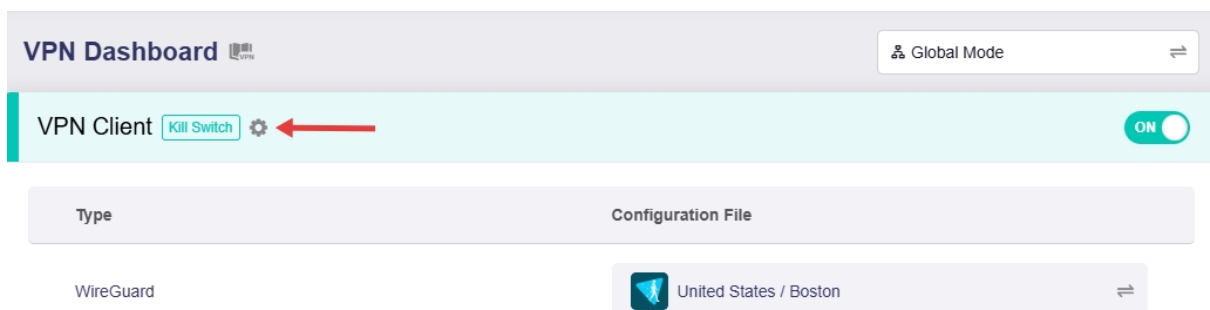

This screenshot is similar to the previous one, but the configuration is for a WireGuard client named "United States / Boston". A red arrow points to the gear icon in the "VPN Client" header, indicating where to click to access advanced settings.

Type	Configuration File
WireGuard	 United States / Boston

Options

Kill Switch ⓘ Failover used when off.	<input checked="" type="checkbox"/>
Services from GL.iNet Use VPN ⓘ	<input type="checkbox"/>
Allow Remote Access to the LAN Subnet ⓘ	<input type="checkbox"/>
IP Masquerading ⓘ	<input checked="" type="checkbox"/>
MTU ⓘ	<input type="text" value="Optional"/>

Cancel

Apply

- **Kill Switch:** If enabled, any traffic routed through this VPN tunnel will be automatically blocked when the VPN connection fails. If disabled, traffic will fall back to the local WAN and access the internet without going through the VPN tunnel.
- **Services from GL.iNet Use VPN:** If enabled, GoodCloud, DDNS, and rty services will transmit packets through VPN tunnels. This option is disabled by default, as these services normally require the device's real IP address to work properly.
- **Allow Remote Access the LAN Subnet:** If enabled, remote access to this router and its LAN devices via VPN will be allowed. The VPN server must advertise a route to the LAN subnet of this router.
- **IP Masquerading:** If enabled, the source IP addresses of LAN clients will be rewritten to the router's VPN tunnel IP. Disable this only for Site-to-Site setups where the remote peer knows your LAN subnets.
- **MTU:** Short for Maximum Transmission Unit. The MTU value you set for the tunnel will override the value defined in the configuration file.

9.2.2 Policy Mode

In this mode, you can connect a single router to multiple VPN servers and customize VPN rules. It is suitable for cases needing flexible traffic management, such as routing different traffic to different destinations through multiple VPN servers.

Switch the VPN Mode to **Policy Mode**, and click **Apply**.

Switch VPN Mode

Global Mode
If the VPN is connected, all traffic will be routed through the VPN. Only one VPN client instance can be activated.

Policy Mode
This mode supports advanced customization, enabling the configuration and activation of multiple VPN servers on a single device, along with the execution of complex policy logic.

After switching, if the VPN is not enabled, the page displays as below, including three sections: **Primary Tunnel**, **Add Tunnel** and **All Other Traffic**.

VPN Dashboard

Policy Mode

1 **Primary Tunnel** Kill Switch OFF

From: All Clients To: All targets Via: Please select a configuration file

Traffic from all devices is allowed by the current rule. Traffic to all destinations is allowed through the current tunnel. The current tunnel is disabled.

2 + Add Tunnel

3 **All Other Traffic** Allow Non-VPN Traffic ON

For all other Internet traffic that is not matched by any of the VPN tunnels and policies above, this option controls whether you want it to go to the Internet. This option is enabled by default to ensure you have normal Internet access besides your VPN traffic.

Allow Non-VPN Traffic : When Enabled, you will have normal Internet access if your traffic does not match any of the policies above.

Enhanced Kill Switch : When Disabled, you are forced to use VPN and policies to access the Internet. All unmatched traffic will be blocked. This option does not override the individual Kill Switch for each policy.

Primary Tunnel

The primary tunnel is a preset tunnel in Policy Mode. It has the highest priority by default, and you can adjust its priority when multiple tunnels are configured.

In this tunnel, you can customize the tunnel rule by setting three factors:

- **From:** It refers to the traffic source, i.e., the traffic that should be routed via this tunnel.
- **To:** It refers to the traffic destination, to which the traffic is routed through this tunnel.
- **Via:** It refers to the traffic routing method, i.e., whether to use VPN.

Priority 1 Primary Tunnel Kill Switch OFF

From: All Clients Traffic from all devices is allowed by the current rule.

To: All Targets Traffic to all destinations is allowed through the current tunnel.

Via: Please select a configuration file The current tunnel is disabled.

Follow the steps below to configure your tunnel rule.

1. Click the left grayed-out box.

Priority 1 Primary Tunnel Kill Switch OFF

From: All Clients To: All Targets Via: Please select a configuration file

2. Select the device that you want to match this rule, and click **Apply**.

From: All Clients

- All Clients
- Specified Connection Types
- Specified Devices
- Exclude Specified Devices

- **All Clients:** If selected, traffic from all devices will match this rule.

- **Specified Connection Types:** If selected, traffic from specified connection types (e.g., LAN subnet, Drop-in Gateway, Guest Network) will match this rule.
- **Specified Devices:** If selected, traffic from specified devices (identified by MAC address) will match this rule.
- **Exclude Specified Devices:** If selected, traffic from specified devices (identified by MAC address) will **NOT** match this rule.

3. Click the middle grayed-out box.

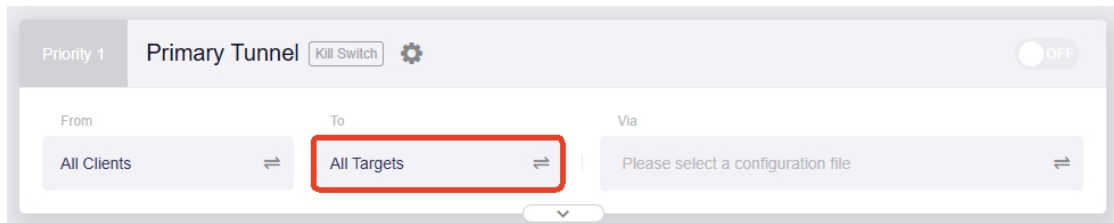

4. Select the destination to which the traffic will be routed via this tunnel, and click **Apply**.

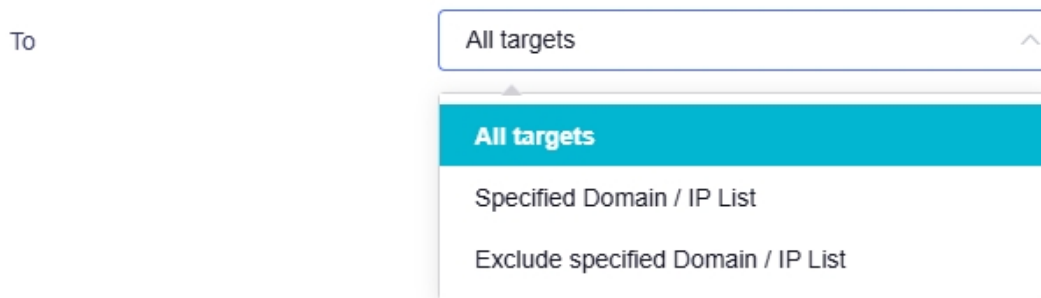

- **All Targets:** If selected, traffic matching this rule will be routed to all destinations.
- **Specified Domain / IP List:** If selected, traffic matching this rule will be routed to specified Domain / IP. You need to enter the specified Domain / IP manually, or enter the Subscription URL link. Specifying a root domain will cover all its subdomains.
- **Exclude specified Domain / IP List:** If selected, traffic matching this rule will **NOT** be routed to specified Domain / IP. You need to enter the specified Domain / IP manually, or enter the Subscription URL link. Specifying a root domain will cover all its subdomains.

Note: If you select Subscribe URL, the domain name or IP address in the URL will be automatically updated every day. Make sure to enter the correct URL. The URL detection will verify the validity of the domain name or IP address.

5. Click the right grayed-out box.

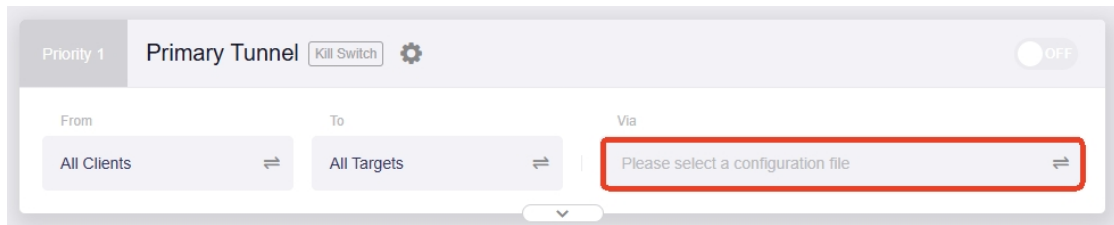

6. Select the routing method for this tunnel: **Use VPN** or **Not Use VPN**.

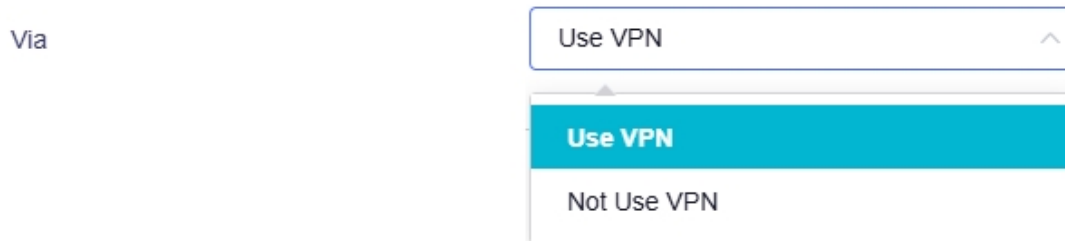

- **Use VPN:** If selected, traffic matching this rule will be routed to the selected destinations via VPN tunnel. You need to select a VPN configuration file for this rule.
- **Not Use VPN:** If selected, traffic matching this rule will be routed to the selected destinations via local WAN network instead of VPN.

7. After configuring the traffic source, destination, and routing method, the primary tunnel rule setup is complete. In the following example, the tunnel rule is: All clients connected to this router will access the Internet via VPN; Their traffic will be routed through this VPN tunnel to the Australia server and eventually exit from this server to the Internet.

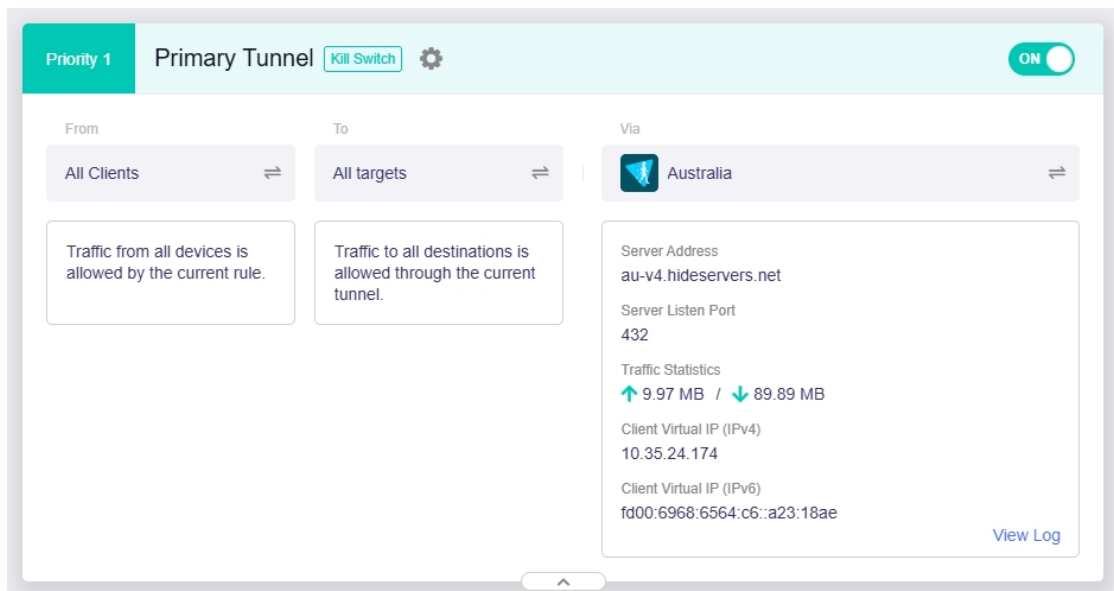

Note: For security, go to [All Other Traffic](#) and [Tunnel Options](#) to check other settings before enabling this tunnel.

Add Tunnel

Add tunnels if you need to route traffic from different devices to different destinations.

Follow the steps below to add a tunnel.

1. Click **Add Tunnel** beneath the Primary Tunnel.

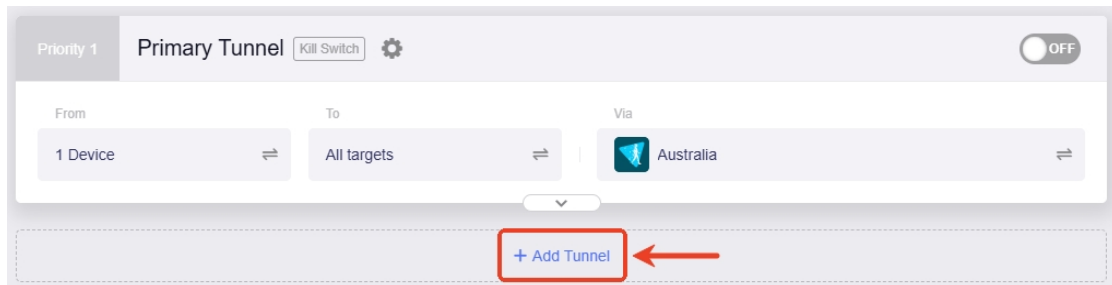

2. Name the tunnel.

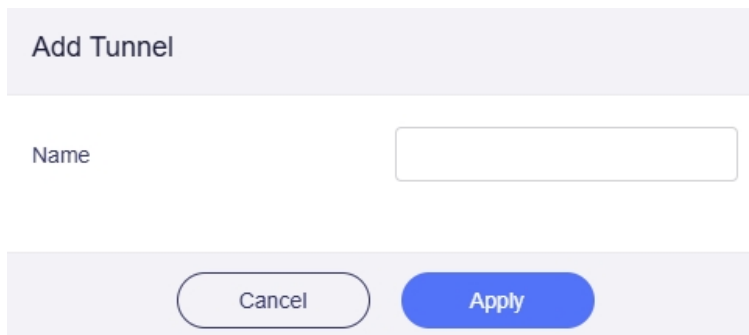
A screenshot of the 'Add Tunnel' dialog box. The title bar says 'Add Tunnel'. Below the title, there is a 'Name' label followed by an empty text input field. At the bottom of the dialog, there are two buttons: 'Cancel' and 'Apply'.

3. You will get one more tunnel on the VPN Dashboard. Up to 5 tunnels can be created (including the preset primary tunnel).

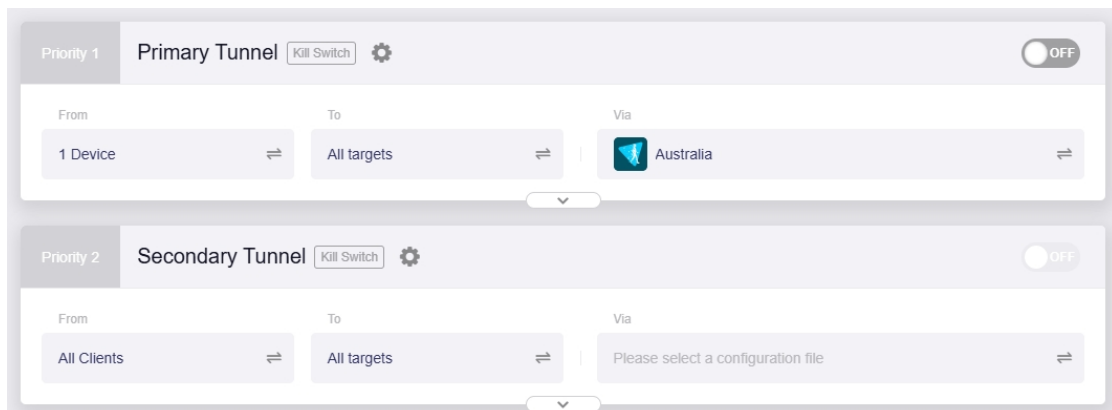

4. Configure tunnel rules by setting the traffic source, destinations and routing method. Once finished, verify other settings in [All Other Traffic](#) and [Tunnel Options](#) for security before enabling the tunnels.

All Other Traffic

In Policy Mode, a pre-enabled default tunnel is shown at the bottom of the VPN Dashboard.

All Other Traffic

Allow Non-VPN Traffic

For all other Internet traffic that is not matched by any of the VPN tunnels and policies above, this option controls whether you want it to go to the Internet. This option is enabled by default to ensure you have normal Internet access besides your VPN traffic.

Allow Non-VPN Traffic : When Enabled, you will have normal Internet access if your traffic does not match any of the policies above.

Enhanced Kill Switch : When Disabled, you are forced to use VPN and policies to access the Internet. All unmatched traffic will be blocked. This option does not override the individual Kill Switch for each policy.

This tunnel controls whether traffic that does not match any of the above VPN tunnel groups can access the Internet. It is enabled by default to ensure normal Internet access for traffic not routed via VPN.

- When enabled, unmatched traffic can still access the Internet.

All Other Traffic

Allow Non-VPN Traffic

For all other Internet traffic that is not matched by any of the VPN tunnels and policies above, this option controls whether you want it to go to the Internet. This option is enabled by default to ensure you have normal Internet access besides your VPN traffic.

Allow Non-VPN Traffic : When Enabled, you will have normal Internet access if your traffic does not match any of the policies above.

Enhanced Kill Switch : When Disabled, you are forced to use VPN and policies to access the Internet. All unmatched traffic will be blocked. This option does not override the individual Kill Switch for each policy.

- When disabled, only traffic routed via VPN is allowed to access the Internet. All non-VPN traffic and traffic that fails over from VPN connections will be blocked. This option does not override the individual Kill Switch for each VPN tunnel.

All Other Traffic

Enhanced Kill Switch

For all other Internet traffic that is not matched by any of the VPN tunnels and policies above, this option controls whether you want it to go to the Internet. This option is enabled by default to ensure you have normal Internet access besides your VPN traffic.

Allow Non-VPN Traffic : When Enabled, you will have normal Internet access if your traffic does not match any of the policies above.

Enhanced Kill Switch : When Disabled, you are forced to use VPN and policies to access the Internet. All unmatched traffic will be blocked. This option does not override the individual Kill Switch for each policy.

Tunnel Priority

By default, the preset Primary Tunnel has the highest priority, followed by other manual-added tunnel (if any), then the preset All Other Traffic tunnel to ensure network connectivity via local ISP (WAN) network.

If you need to modify tunnel priority, follow the steps below.

1. Click the priority label in the upper left corner of any tunnel (e.g., Priority 1 / Priority 2).

The screenshot shows the 'VPN Dashboard' interface. At the top right, there is a 'Policy Mode' dropdown menu. Below it, two tunnel configurations are visible. The first tunnel is 'Primary Tunnel' with a 'Priority 1' label in a red box. It has a 'Kill Switch' button and a gear icon, and is currently 'OFF'. The configuration shows 'From: All Clients', 'To: All targets', and 'Via: Please select a configuration file'. The second tunnel is 'Secondary Tunnel' with a 'Priority 2' label in a red box. It also has a 'Kill Switch' button and a gear icon, and is currently 'OFF'. Its configuration is identical to the Primary Tunnel. A small downward arrow is visible between the two tunnel panels.

2. In the pop-up window, click and hold the three-line icon on the right to reorder the tunnel, then click **Apply**.

The screenshot shows a 'Tunnels Priority' pop-up window. It contains a list of two tunnels: '1 Primary Tunnel' and '2 Secondary Tunnel'. Each tunnel entry has a three-line reorder icon on the right. At the bottom of the window, there are two buttons: 'Cancel' and 'Apply'.

When multiple tunnels are enabled, the router will route traffic in the following order:

1. Traffic will first attempt to match the highest-priority tunnel rule. If matched, it will be routed through that tunnel; otherwise, it will try the next priority tunnel, and so on, until it matches the "All Other Traffic" tunnel.
2. If a VPN tunnel disconnects unexpectedly, the system will determine whether to fail over the traffic to the next priority tunnel based on whether this tunnel's **Kill Switch** is enabled.
 - When the Kill Switch is enabled, traffic will be blocked and will not fail over to the next priority tunnel.
 - When the Kill Switch is disabled, traffic will fail over to the next priority tunnel and attempt to match its tunnel rules.
3. The **All Other Traffic** tunnel is enabled by default to ensure that traffic not matching the VPN tunnels can still access the Internet.
 - If enabled, it routes unmatched or failover traffic through the local WAN.
 - If disabled, it strengthens the Kill Switch and blocks regular Internet access to prevent IP leaks.

Tunnel Options

You can configure advanced settings for each VPN tunnel, such as the VPN Kill Switch, IP Masquerading, and MTU. Click the gear icon next to a tunnel name.

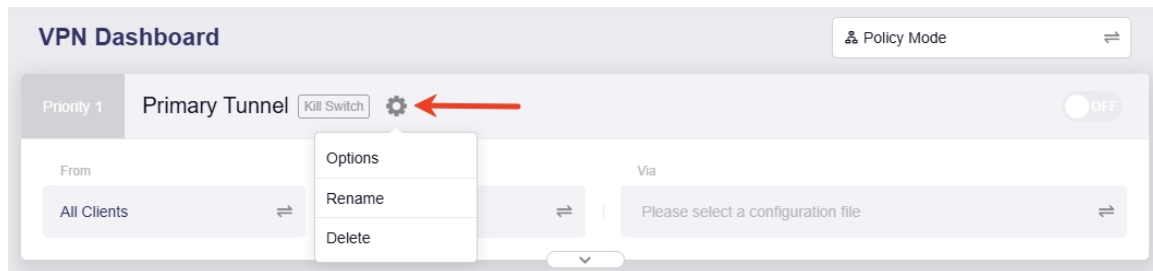

Primary Tunnel-Options

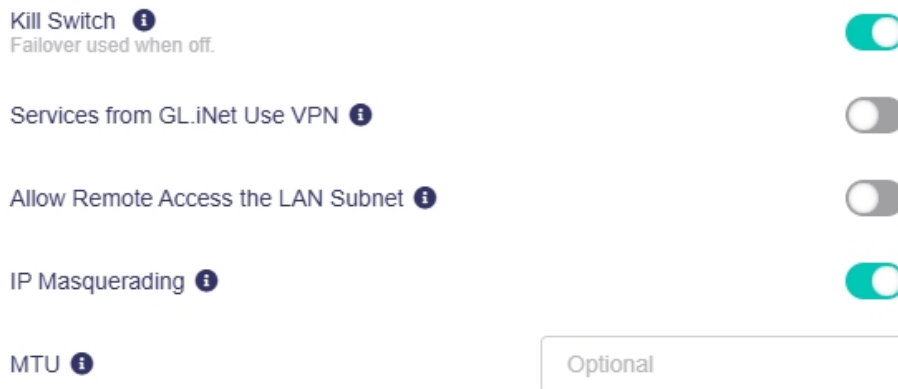

- **Kill Switch:** If enabled, any traffic routed through this VPN tunnel will be automatically blocked if the VPN connection fails. If disabled, traffic will fail over to the next priority tunnel or the local WAN.
- **Services from GL.iNet Use VPN:** If enabled, GoodCloud, DDNS, and rtty services will transmit packets through VPN tunnels. This option is disabled by default, as these services normally require the device's real IP address to work properly.
- **Allow Remote Access the LAN Subnet:** If enabled, remote access to this router and its LAN devices via VPN will be allowed. The VPN server must advertise a route to the LAN subnet of this router.
- **IP Masquerading:** If enabled, the source IP addresses of LAN clients will be rewritten to the router's VPN tunnel IP. Disable this only for Site-to-Site setups where the remote peer knows your LAN subnets.
- **MTU:** The MTU you set for the tunnel will overwrite the value in the configuration file.

Chapter 10

Set Up VPN Server

This chapter introduces how to set up a GL.iNet router as OpenVPN or WireGuard server.

10.1 Set Up OpenVPN Server

OpenVPN is an open-source VPN protocol that utilizes SSL/TLS encryption for secure point-to-point and site-to-site connections. To set up OpenVPN server on a GL.iNet router, watch [this video](#) or refer to the steps below.

10.1.1 Preparation

1. Make sure you have a public IP address

Click [here](#) to verify if your Internet Service Provider (ISP) assigns you a public IP address. If not, your router cannot be set as an OpenVPN server.

Alternative methods:

- If you have a primary router upstream of your GL.iNet router, log in to it and verify it has a public IP address assigned by your ISP.
- Ask your ISP for a public IP address. This may incur an extra fee.
- If the above two methods don't work (e.g., if your network is behind CGNAT), you may try our SD-WAN solution [AstroWarp](#).

2. Confirm if Port Forwarding is required

- If your GL.iNet router is the primary router in your network, no port forwarding setup is required. Proceed to the next step.
- If a primary router is already in use and your GL.iNet router is configured as a secondary router, you will need to configure port forwarding on the primary router.
- If your GL.iNet router is multiple levels downstream from the primary router, configure port forwarding on each intermediate device.

10.1.2 Setup Steps

1. Log in to the router's web admin panel, navigate to **VPN > OpenVPN Server**, then click **Generate Configuration** (for VPN server initial setup only).

2. Apply the configuration.

The default configuration works for most cases. Click **Export Client Configuration** at the bottom and proceed to step 3. If you have modified the configuration, click **Apply** before exporting it.

The screenshot shows the configuration interface for an OpenVPN server. It features three tabs: Configuration, Users, and Route Rules. The Configuration tab is selected. The settings are as follows:

- Device Mode: TUN
- Protocol: UDP
- Local Port: 1194
- IPv4 Subnet: 10.8.0.0/24
- IPv6 Subnet: fd00:a79f:8609:088f::0/64
- Authentication Mode: Certificate only

At the bottom of the configuration area, there are three buttons: a grey "Reset" button, a blue "Apply" button, and a blue "Export Client Configuration" button which is highlighted with a red rectangular box. To the right of these buttons is a blue "Advanced Configuration" dropdown menu.

- **Device Mode:** TAP-S2S or Tun. See [here](#) for the differences.
- **Protocol:** UDP or TCP. See [here](#) for the differences.
- **Authentication Mode:** This determines the authentication method used when the client connects to the server. There are three options:

- **Certificate Only:** If selected, the router will automatically generate a server and client certificate keys and embed them in the configuration file. When you upload the configuration to the client, no additional credentials are required.
 - **Username/Password Only:** If selected, the router will generate client configuration without certificate keys. You need to first add a username and password in the **Users** tab before exporting the client configuration. When uploading the configuration to the client, enter these credentials for authentication.
 - **Username/Password and Certificate:** If selected, you need to first add a username and password in the **Users** tab before exporting the client configuration; second, the router will automatically generate server and client certificate keys and embed them in the configuration file. When uploading the configuration to the client, the certificate-key will be verified first, followed by username/password authentication for 2FA security.
 - **Advanced Configuration:** Customize more server settings as needed.
3. Export Client Configuration.

After clicking **Export Client Configuration** at the bottom of the Configuration tab (or applying the modified configuration), a window will pop up as follows. Click **Download** to export the configuration.

The screenshot shows a dialog box titled "Export Client Configuration" with a close button (X) in the top right corner. Below the title bar is a light blue informational message: "Use DDNS domain to avoid the situation where a client cannot connect to the VPN service because of a change to the public IP address provided by your ISP. If you want to activate this function, please [Enable DDNS](#) on your router." Below this message is an "Address" input field with a small information icon (i) to its left, containing the text "183.178.100.100". At the bottom of the dialog is a blue "Download" button.

Tips:

- If your public IP address changes frequently, go to **APPLICATIONS > Dynamic DNS** and enable DDNS. You can then use the DDNS domain as your server address.
- Since firmware v4.8, you can select the server address from a drop-down list before exporting the configuration file: Public IP, DDNS domain, and current WAN IP

address. Once selected, the server address in the configuration file will be updated automatically. Re-download the configuration file if the server address is changed.

4. Start OpenVPN server.

On the **OpenVPN Server** page, click the **Start** button in the upper right corner to start the server.

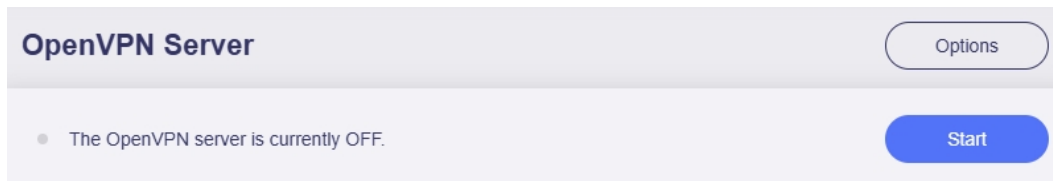

The server connection status is displayed at the top. If it shows upload and download traffic statistics, it means the OpenVPN server is running.

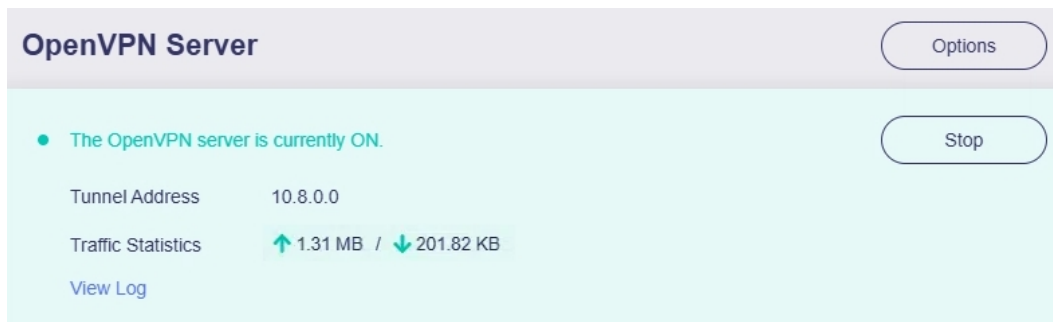

10.1.3 Troubleshooting

If the connection fails, there are several common reasons:

- The VPN server does not have a public IP address. See [here](#) for troubleshooting.
- You may need to set up port forwarding. See [here](#) for troubleshooting.
- The port used for the OpenVPN Server is blocked by your Internet Service Provider. Change to another port, or contact your ISP for assistance.
- The VPN connection may be blocked in certain countries or regions.

10.2 Set Up WireGuard Server

WireGuard® is a simple yet fast and modern VPN that utilizes state-of-the-art cryptography. It aims to be faster, simpler, and more useful than IPsec, while avoiding the massive headache. It intends to be considerably more performant than OpenVPN. To set up WireGuard server on a GL.iNet router, watch [this video](#) or refer to the steps below.

10.2.1 Preparation

1. Make sure you have a public IP address

Click [here](#) to verify if your Internet Service Provider assigns you a public IP address. If not, your router cannot be set as a WireGuard Server.

Alternative methods:

- If you have a primary router upstream of your GL.iNet router, log in to it and verify it has a public IP address assigned by your ISP.
- Ask your ISP for a public IP address. This may incur an extra fee.
- If the above two methods don't work (e.g., if your network is behind CGNAT), you may try our SD-WAN solution [AstroWarp](#).

2. Confirm if Port Forwarding is required

- If your GL.iNet router is the primary router in your network, no port forwarding setup is required. Proceed to the next step.
- If a primary router is already in use and your GL.iNet router is configured as a secondary router, you will need to configure port forwarding on the primary router.
- If your GL.iNet router is multiple levels downstream from the primary router, configure port forwarding on each intermediate device.

10.2.2 Setup Steps

1. Log in to the router's web admin panel, navigate to **VPN > WireGuard Server**, then click **Generate Configuration** (for VPN server initial setup only).
2. Apply the configuration.

The default configuration works for most cases. No need to modify the IPv4 address unless it conflicts with your upstream router's gateway.

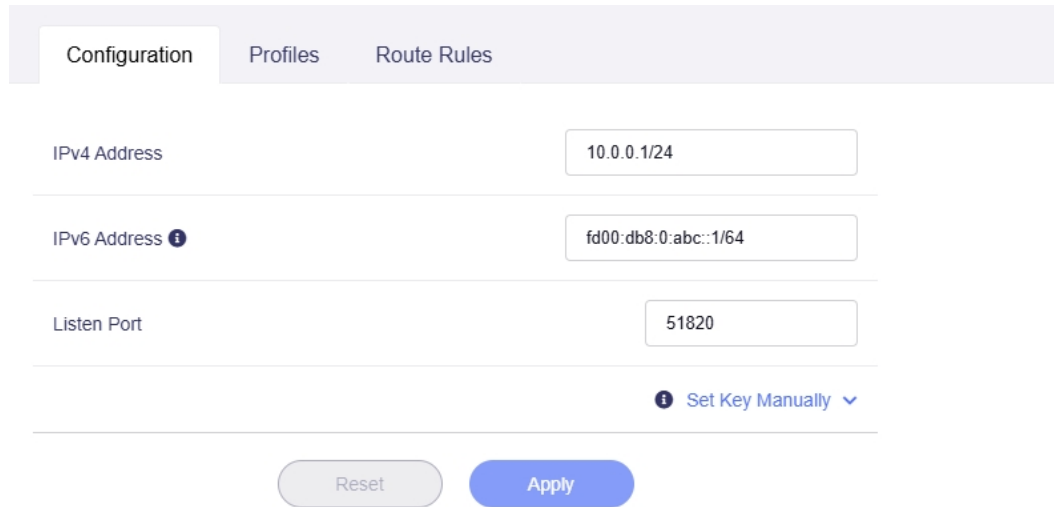

The screenshot shows the 'Configuration' tab of the WireGuard Server setup. It features three input fields: 'IPv4 Address' with the value '10.0.0.1/24', 'IPv6 Address' with the value 'fd00:db8:0:abc::1/64', and 'Listen Port' with the value '51820'. Below these fields is a link 'Set Key Manually' with a dropdown arrow. At the bottom are two buttons: 'Reset' and 'Apply'.

If the IPv4 address conflicts with your upstream router's gateway, modify the IPv4 address to another one (e.g., **10.1.0.1/24**) and click **Apply**. Ensure the "/24" CIDR notation is included to avoid connectivity issues.

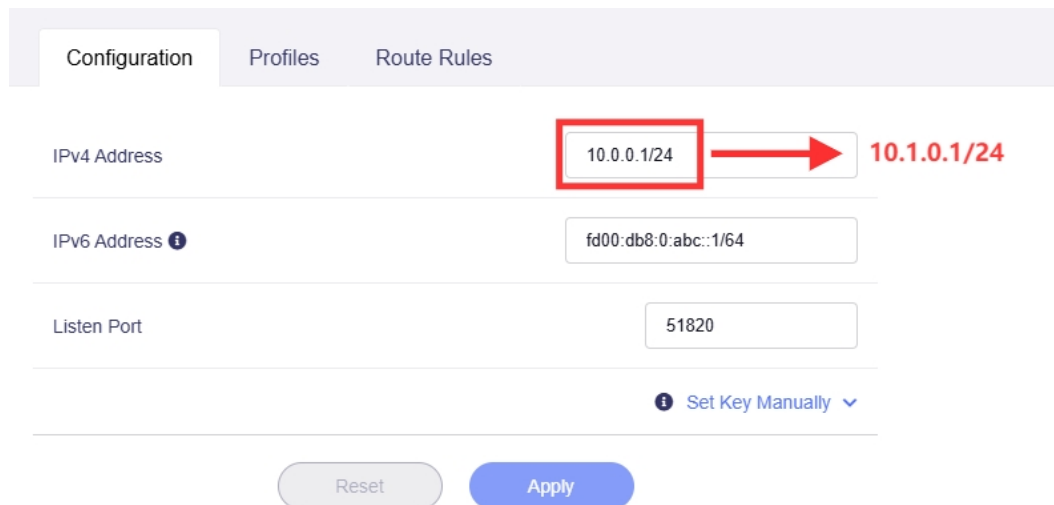

This screenshot is identical to the previous one, but with a red box around the '10.0.0.1/24' text in the IPv4 Address field. A red arrow points from this box to the text '10.1.0.1/24' to the right, indicating the intended change.

3. Add a profile.
Switch to **Profiles** tab, click the **Add** button to generate a profile for your device.

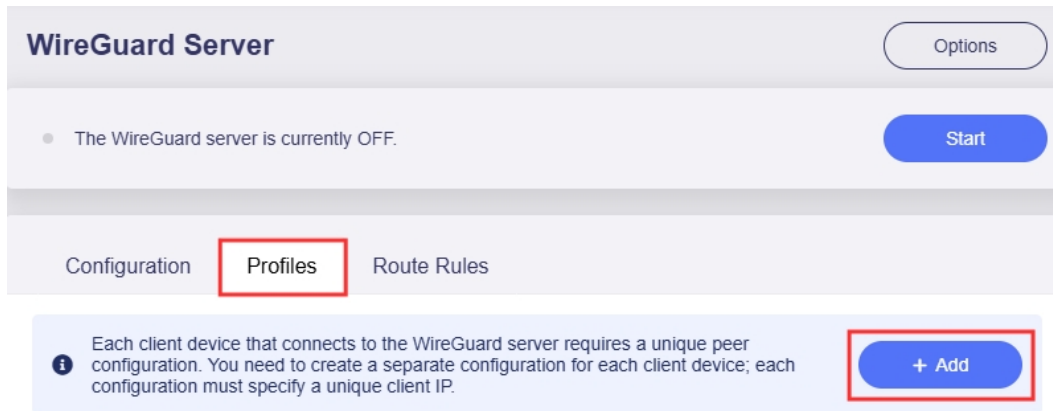

Set a descriptive name and click **Apply** to continue.

Client Configuration

Name

[Set More](#)

Tip: If you want to access the WireGuard client's LAN devices from your WireGuard server, switch to the **Route Rules** tab to configure route rules. See [here](#) for details.

4. Download configuration.

After adding a profile, the router will generate a configuration file in three formats: QR code, plain text, and .conf file. Choose your preferred method to obtain the configuration file.

- **QR code:** Suitable for devices (e.g., smartphones, tablets, laptops) with the WireGuard App installed. If you want to set a specific device as a WireGuard client, simply open the WireGuard App and scan the QR code to import a configuration file.
- **Plain text:** In plain text format, you can review configuration details and conveniently copy-paste them elsewhere for manual configuration, such as the WireGuard App or a GL.iNet router.
- **.conf file:** Click the **Download** button to save the .conf file to your local device. It is also convenient and can be directly uploaded to the WireGuard app or a GL.iNet router.

5. Start WireGuard server.

On the **WireGuard Server** page, click the **Start** button in the upper right corner to start the server.

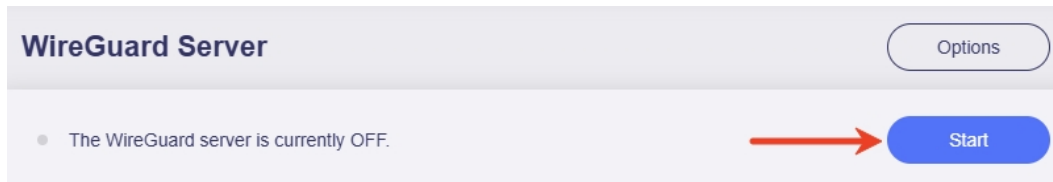

The server connection status is displayed at the top. If it shows upload, download traffic statistics, and online connected devices, it means the WireGuard server is running.

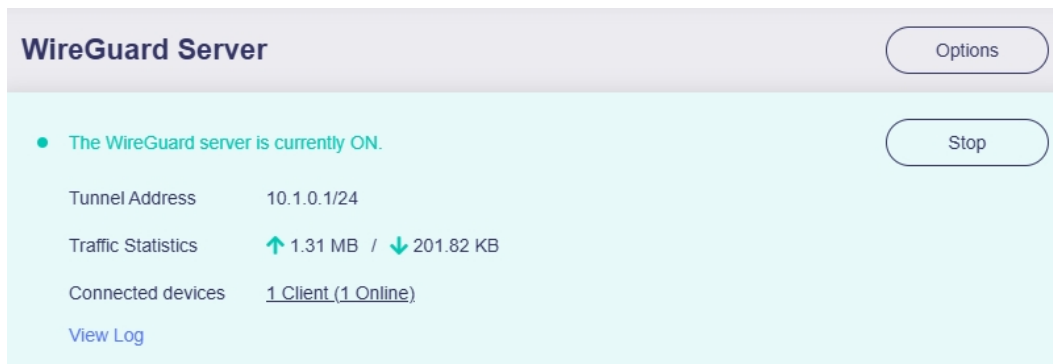

10.2.3 Troubleshooting

If the connection fails, there are several common reasons:

- The VPN server does not have a public IP address. See [here](#) for troubleshooting.
- You may need to set up port forwarding. See [here](#) for troubleshooting.
- The port used for the WireGuard Server is blocked by your Internet Service Provider. Change to another port, or contact your ISP for assistance.
- The VPN connection may be blocked in certain countries or regions.

Chapter 11

Set Up VPN Client

This chapter introduces how to set up a GL.iNet router as OpenVPN or WireGuard client.

11.1 Set Up OpenVPN Client

11.1.1 Preparation

First, ensure you have an active subscription with a VPN service provider that supports manual OpenVPN configuration. See [here](#) for the OpenVPN providers compatible with GL.iNet.

Next, visit the official website of the VPN service provider you subscribed and obtain service credentials or configuration file. If you don't know how to get the configuration file, refer to [this link](#) or contact their support.

11.1.2 Set Up NordVPN

NordVPN is integrated into the GL.iNet web admin panel. You can acquire configuration files for all NordVPN servers by entering your account credentials (obtained from the NordVPN Dashboard) in the router's web admin panel or GL.iNet mobile app, eliminating the need for manual file uploads.

Follow the steps below to set your router as a NordVPN client.

1. Log in to your NordVPN web account [here](#).
2. On the Nord Dashboard, click **NordVPN**, then click **Set up NordVPN manually**.

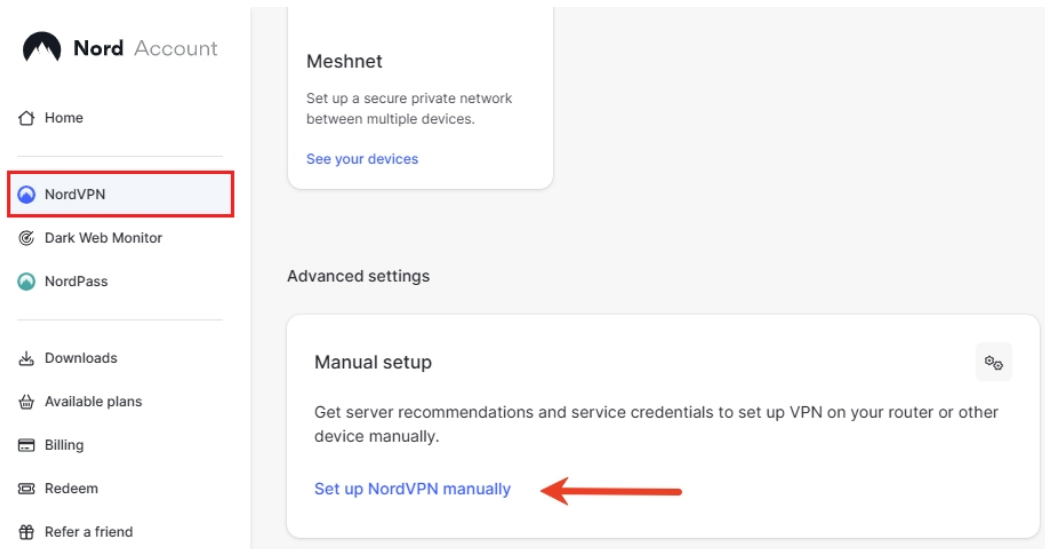

You will find the **service credentials**. Copy them for later use.

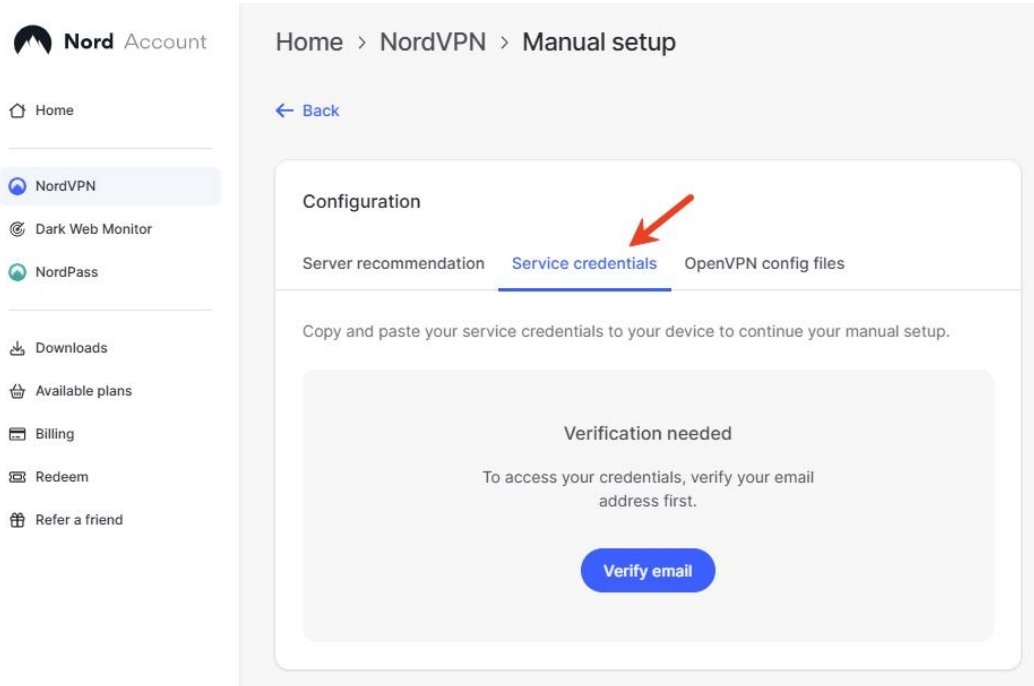

3. Log in to your router's web admin panel and navigate to **VPN > OpenVPN Client > NordVPN**. Input the service credentials (Note: It is NOT the login account email/password), then click **Save and Continue**.

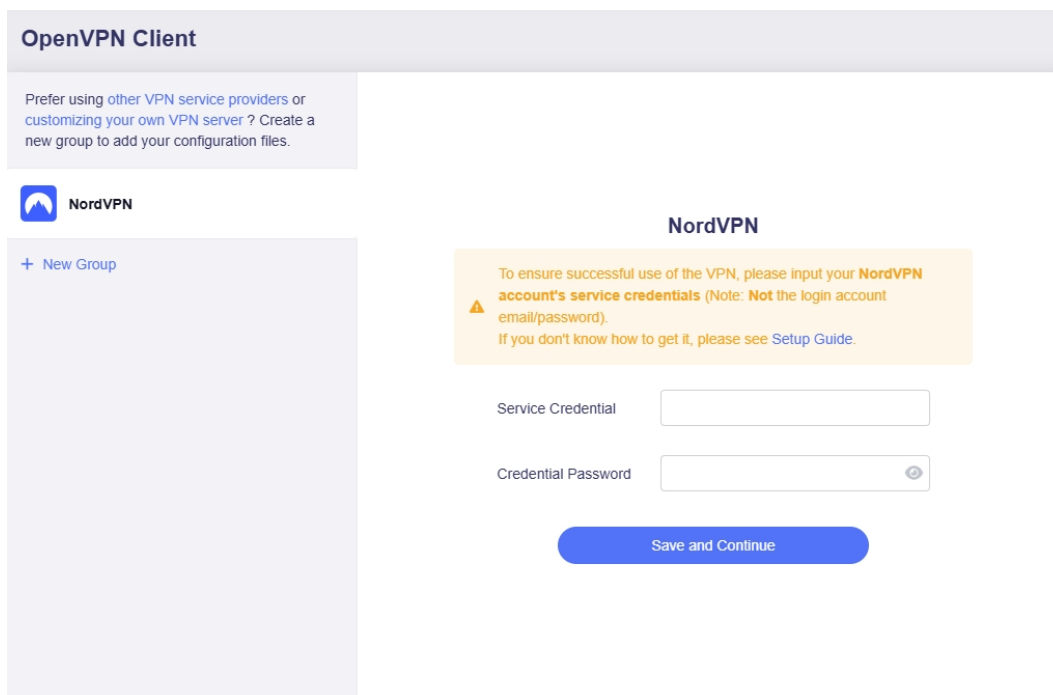

4. Select protocol, max server count of each location and locations, then click **Apply**.

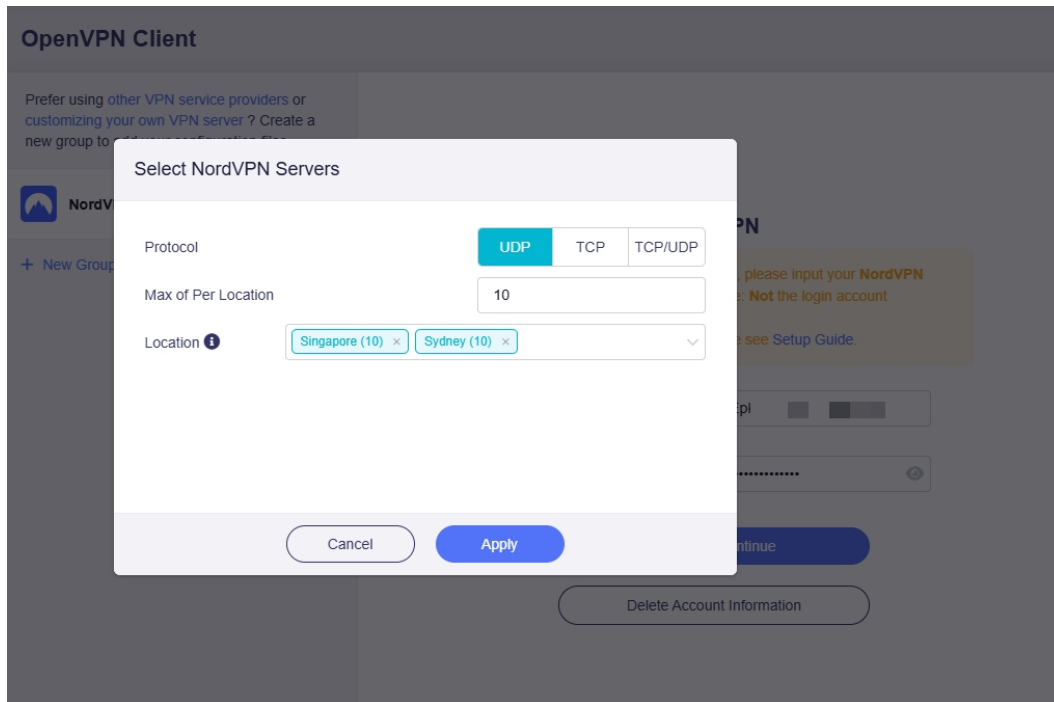

It will download configuration files.

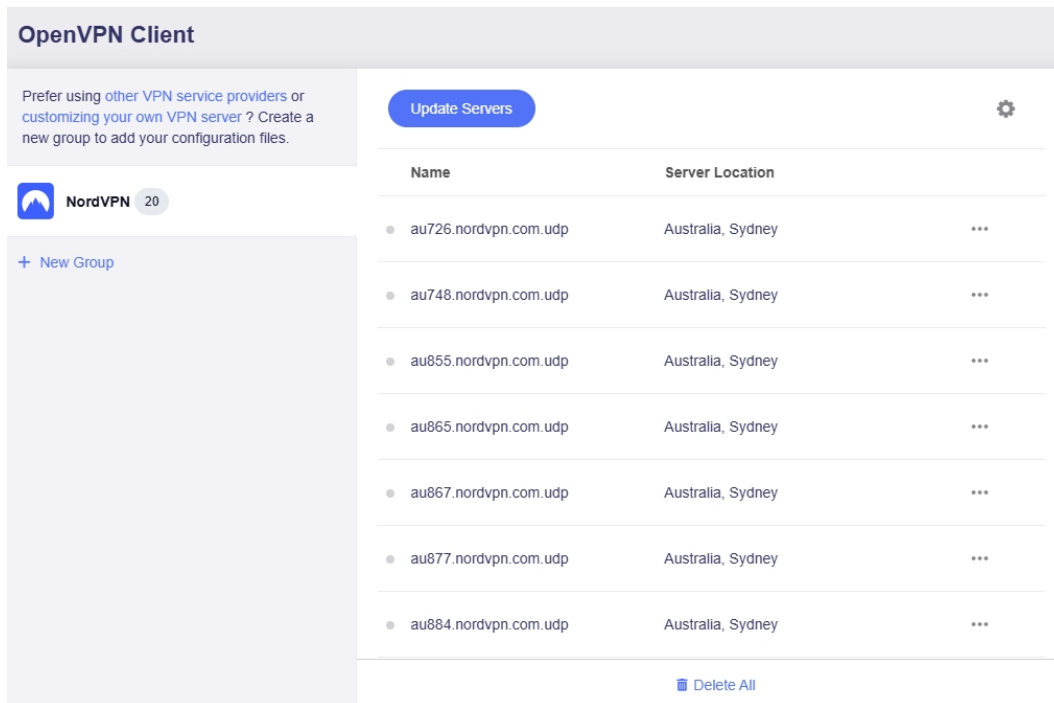

5. Start a connection.

Select a server, and click the three-dot icon on the right to start a connection.

OpenVPN Client

Prefer using other VPN service providers or customizing your own VPN server ? Create a new group to add your configuration files.

 NordVPN 20

+ New Group

Update Servers 

Name	Server Location	
● au726.nordvpn.com.udp	Australia, Sydney	...
● au748.nordvpn.com.udp	Australia, Sydney	<div style="border: 1px solid red; padding: 2px;">▶ Start</div> Delete
● au855.nordvpn.com.udp	Australia, Sydney	...
● au865.nordvpn.com.udp	Australia, Sydney	...
● au867.nordvpn.com.udp	Australia, Sydney	...
● au877.nordvpn.com.udp	Australia, Sydney	...
● au884.nordvpn.com.udp	Australia, Sydney	...

 Delete All

- Once connected, a green dot will appear next to the configuration file.

OpenVPN Client

Prefer using other VPN service providers or customizing your own VPN server ? Create a new group to add your configuration files.

 NordVPN 20

+ New Group

Update Servers 

Name	Server Location	
● au726.nordvpn.com.udp	Australia, Sydney	...
● au748.nordvpn.com.udp	Australia, Sydney	...
● au855.nordvpn.com.udp	Australia, Sydney	...
● au865.nordvpn.com.udp	Australia, Sydney	...
● au867.nordvpn.com.udp	Australia, Sydney	...
● au877.nordvpn.com.udp	Australia, Sydney	...
● au884.nordvpn.com.udp	Australia, Sydney	...
● au889.nordvpn.com.udp	Australia, Sydney	...

You can also check the VPN connection details on the **VPN Dashboard**.

- Update servers.

You can click **Update Servers** to obtain the latest available server list, avoiding connection failures caused by server maintenance or shutdown.

OpenVPN Client

Prefer using other VPN service providers or customizing your own VPN server ? Create a new group to add your configuration files.

Update Servers 

 NordVPN 20

+ New Group

Name	Server Location	
● au726.nordvpn.com.udp	Australia, Sydney	...
● au748.nordvpn.com.udp	Australia, Sydney	...
● au855.nordvpn.com.udp	Australia, Sydney	...
● au865.nordvpn.com.udp	Australia, Sydney	...
● au867.nordvpn.com.udp	Australia, Sydney	...
● au877.nordvpn.com.udp	Australia, Sydney	...
● au884.nordvpn.com.udp	Australia, Sydney	...





8. Edit credentials.

Click the gear icon to edit your login credentials.

OpenVPN Client

Prefer using other VPN service providers or customizing your own VPN server ? Create a new group to add your configuration files.

Update Servers 

 NordVPN 20

+ New Group

Name	Server Location	
● au726.nordvpn.com.udp	Australia, Sydney	...
● au748.nordvpn.com.udp	Australia, Sydney	...
● au855.nordvpn.com.udp	Australia, Sydney	...
● au865.nordvpn.com.udp	Australia, Sydney	...
● au867.nordvpn.com.udp	Australia, Sydney	...
● au877.nordvpn.com.udp	Australia, Sydney	...
● au884.nordvpn.com.udp	Australia, Sydney	...



9. Delete all files.

You can click **Delete All** to delete all configuration files with one click.

OpenVPN Client

Prefer using other VPN service providers or customizing your own VPN server ? Create a new group to add your configuration files.

Update Servers



NordVPN 20

+ New Group

Caution

Are you sure you want to clear all?

Cancel Delete

Name	Server Location	
• au726.nordvpn.com.udp	Australia, Sydney	...
	Australia, Sydney	...
	Australia, Sydney	...
	Australia, Sydney	...
• au867.nordvpn.com.udp	Australia, Sydney	...
• au877.nordvpn.com.udp	Australia, Sydney	...
• au884.nordvpn.com.udp	Australia, Sydney	...

Delete All

11.1.3 Set Up OpenVPN Client Manually (for other providers)

If your OpenVPN service provider is not integrated into our admin panel, please first visit the official website of your subscribed service provider to obtain the configuration file. Then upload it to the router to set up an OpenVPN client.

In the following steps, we will use PIA (Private Internet Access) as an example.

1. Download a configuration file from Private Internet Access official website.
2. Log in to your router's web admin panel, navigate to **VPN > OpenVPN Client**, and click **Add Manually**.

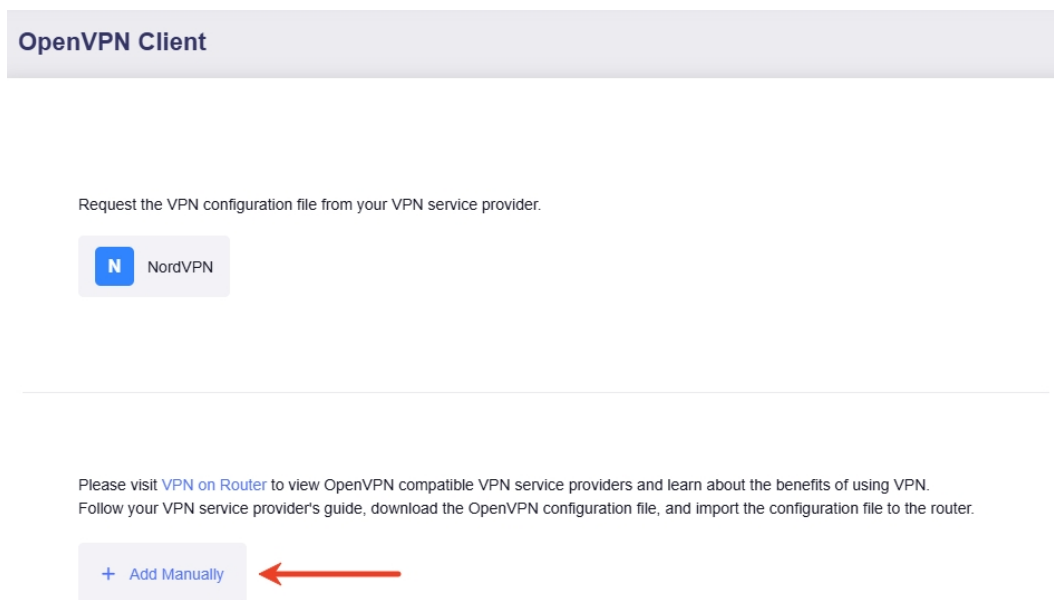

3. It will create a group on the left sidebar. Set a descriptive name for the group.

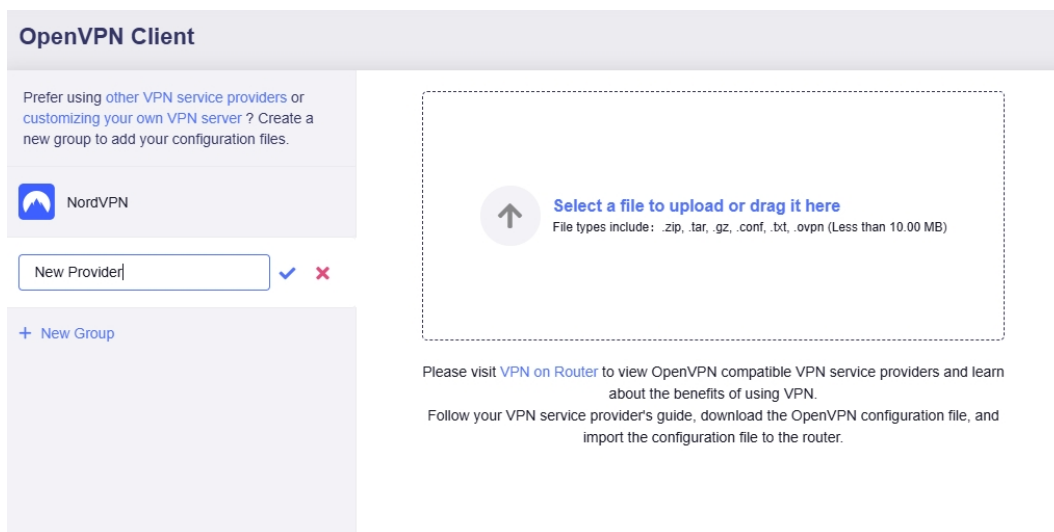

4. Upload your OpenVPN configuration file. Input the credentials if required, then click **Apply**.

The screenshot shows the 'OpenVPN Client' interface. On the left, there is a sidebar with a NordVPN logo and a 'Private Internet Access' section. The main area displays a large green confirmation box with a checkmark and the text 'Upload successful' and 'ca_toronto-aes-128-cbc-udp-dns.ovpn'. Below this is a 'Re-upload file' button. A yellow warning box states: '1 valid configuration files have been detected. Please enter the username and password. If these configurations use different passwords, you will need to enter the password individually for each configuration file.' Below the warning are input fields for 'Username' and 'Password', and an 'Apply' button.

You will see the configuration file uploaded.

The screenshot shows the 'OpenVPN Client' interface with the configuration file now listed in a table. The table has columns for 'Name' and 'Server Address'. The row contains 'ca_toronto-aes-128-cbc-udp-dns' and 'ca-toronto.privacy.network:1198'. A three-dot menu icon is visible to the right of the row.

Name	Server Address
ca_toronto-aes-128-cbc-udp-dns	ca-toronto.privacy.network:1198

5. Click the three-dot icon on the right to start a connection.

The screenshot shows the 'OpenVPN Client' interface with the context menu open for the configuration file. The menu options are 'Start', 'Modify', and 'Delete'. The 'Start' option is highlighted with a red box.

Name	Server Address
ca_toronto-aes-128-cbc-udp-dns	ca-toronto.privacy.network:1198

- Start
- Modify
- Delete

- Once connected, a green dot will appear next to the configuration file.

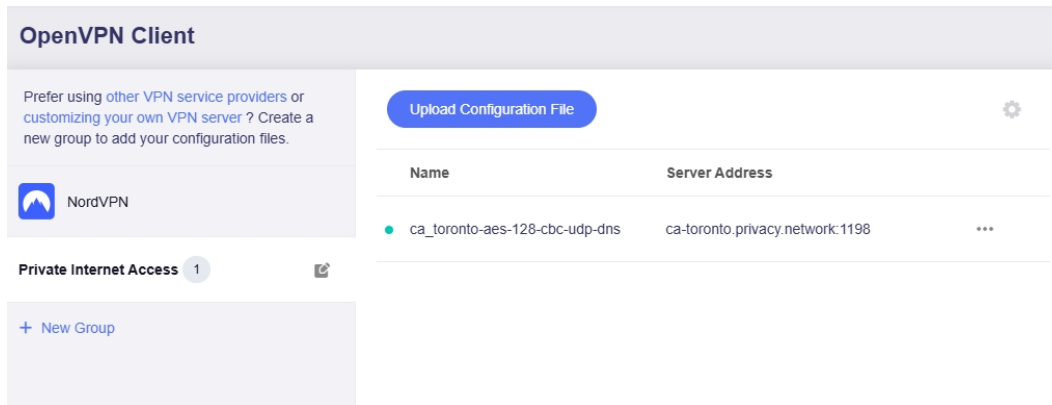

The screenshot shows the OpenVPN Client interface. On the left, there is a sidebar with a NordVPN logo and a 'Private Internet Access' section with a notification badge '1'. Below that is a '+ New Group' button. The main area features an 'Upload Configuration File' button and a table of VPN configurations.

Name	Server Address	
ca_toronto-aes-128-cbc-udp-dns	ca-toronto.privacy.network:1198	•••

You can also check the VPN connection details on the **VPN Dashboard**.

11.2 Set Up WireGuard Client

You can set up WireGuard Client via the GL.iNet mobile app or the web admin panel.

- The mobile app integrates some WireGuard service providers, such as AzireVPN, Mullvad VPN, OVPN, StrongVPN, PIA VPN. You can set it up easily by entering the login credentials of the WireGuard service you subscribed to. Open the app and follow the on-screen instructions to set up.
- The web admin panel not only integrates some WireGuard service providers, but also provides an entry for manual configuration. You can either enter the credentials of your subscribed WireGuard service for quick setup, or manually upload a configuration file to complete the setup.

11.2.1 Preparation

First, ensure you have an active subscription with a VPN service provider that supports manual WireGuard configuration. See [here](#) for the WireGuard providers compatible with GL.iNet.

Next, select the corresponding WireGuard service provider below to quickly locate the step-by-step instructions.

- [Set Up AzireVPN](#)
- [Set Up Hide.me](#)
- [Set Up IPVanish](#)
- [Set Up Mullvad](#)
- [Set Up NordVPN](#)
- [Set Up PIA \(Private Internet Access\)](#)
- [Set Up PureVPN](#)
- [Set Up Surfshark](#)
- [Set Up Windscribe](#)
- [Set Up WireGuard Client Manually \(for other providers\)](#)

11.2.2 Set Up AzireVPN

Follow the steps below to set your router as an AzireVPN client.

1. Log in to your router's web admin panel and go to **VPN > WireGuard Client > AzireVPN**.
2. Input Username and Password, then click **Save and Continue**. It will generate configuration files for each server.

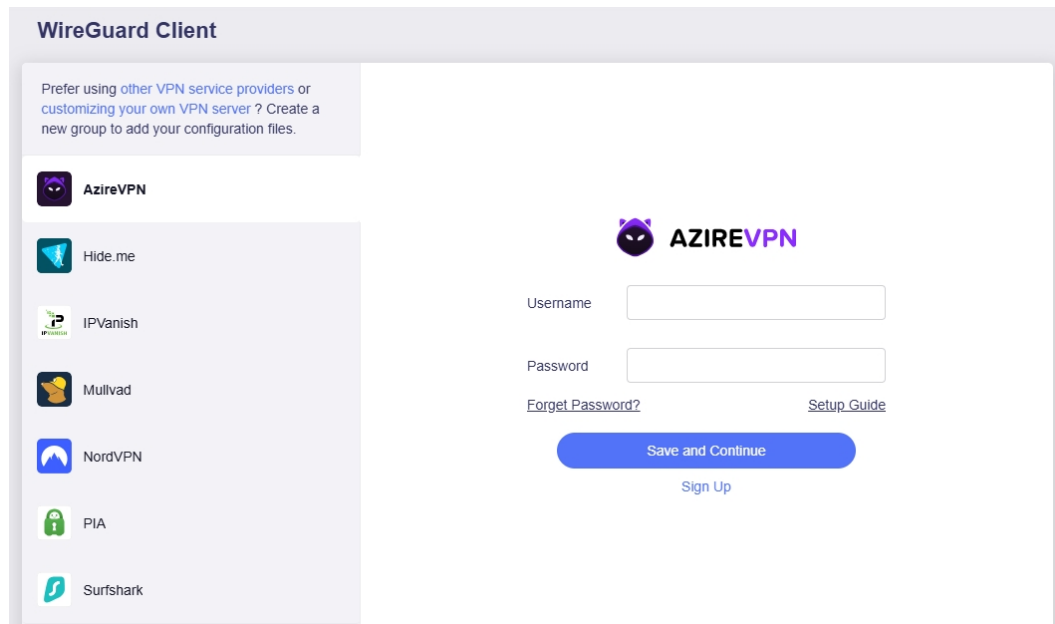

3. Select a preferred server, and click the three-dot icon on the right to start a connection.

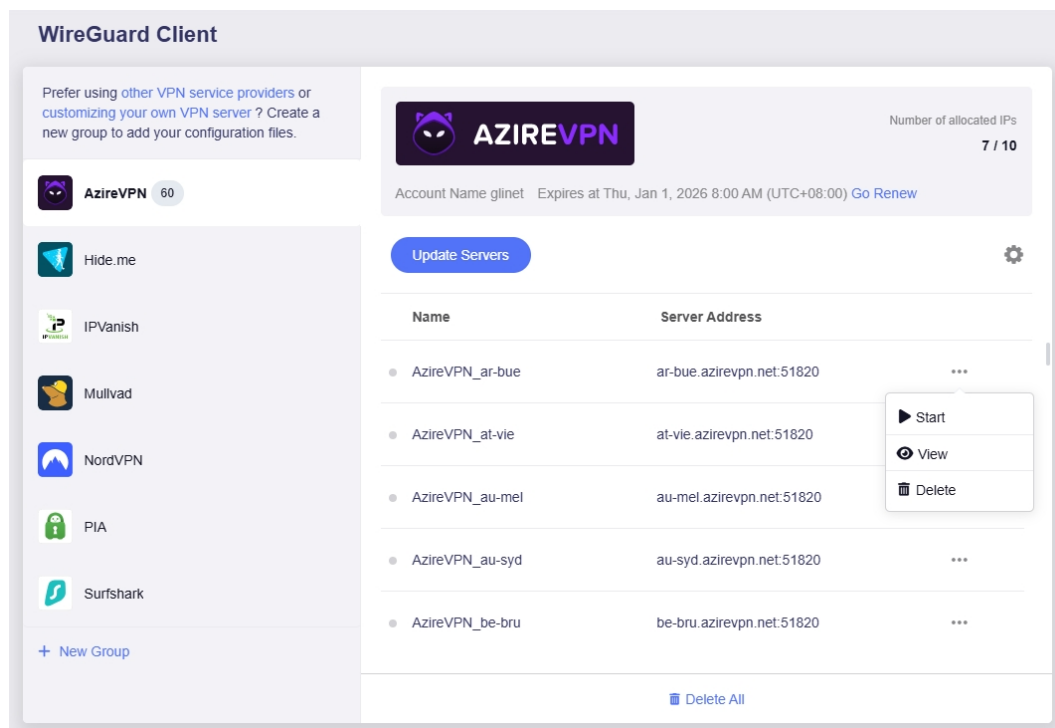

4. Once connected, a green dot will appear next to the configuration file.

The screenshot shows the WireGuard Client interface for the AzireVPN group. On the left, there is a sidebar with various VPN providers: AzireVPN (60), Hide.me, IPVanish, Mullvad, NordVPN, PIA, and Surfshark. The main area displays the AzireVPN logo and account details: Account Name: glinet, Expires at: Thu, Jan 1, 2026 8:00 AM (UTC+08:00), and a 'Go Renew' link. The 'Number of allocated IPs' is shown as 8 / 10. A blue 'Update Servers' button is prominently displayed. Below it is a table of servers:

Name	Server Address	
AzireVPN_ar-bue	ar-bue.azirevpn.net:51820	...
AzireVPN_at-vie	at-vie.azirevpn.net:51820	...
AzireVPN_au-mel	au-mel.azirevpn.net:51820	...
AzireVPN_au-syd	au-syd.azirevpn.net:51820	...
AzireVPN_be-bru	be-bru.azirevpn.net:51820	...

You can also check the VPN connection details on the **VPN Dashboard**.

5. Update servers.

You can click **Update Servers** to obtain the latest available server list, avoiding connection failures caused by server maintenance or shutdown.

This screenshot is similar to the previous one, but the 'Number of allocated IPs' is now 9 / 10. A red arrow points to the 'Update Servers' button. At the bottom of the server list, there is a 'Delete All' button.

Name	Server Address	
AzireVPN_ar-bue	ar-bue.azirevpn.net:51820	...
AzireVPN_at-vie	at-vie.azirevpn.net:51820	...
AzireVPN_au-mel	au-mel.azirevpn.net:51820	...
AzireVPN_au-syd	au-syd.azirevpn.net:51820	...
AzireVPN_be-bru	be-bru.azirevpn.net:51820	...

6. Edit credentials or logout.

Click the gear icon to edit your login credentials or log out.

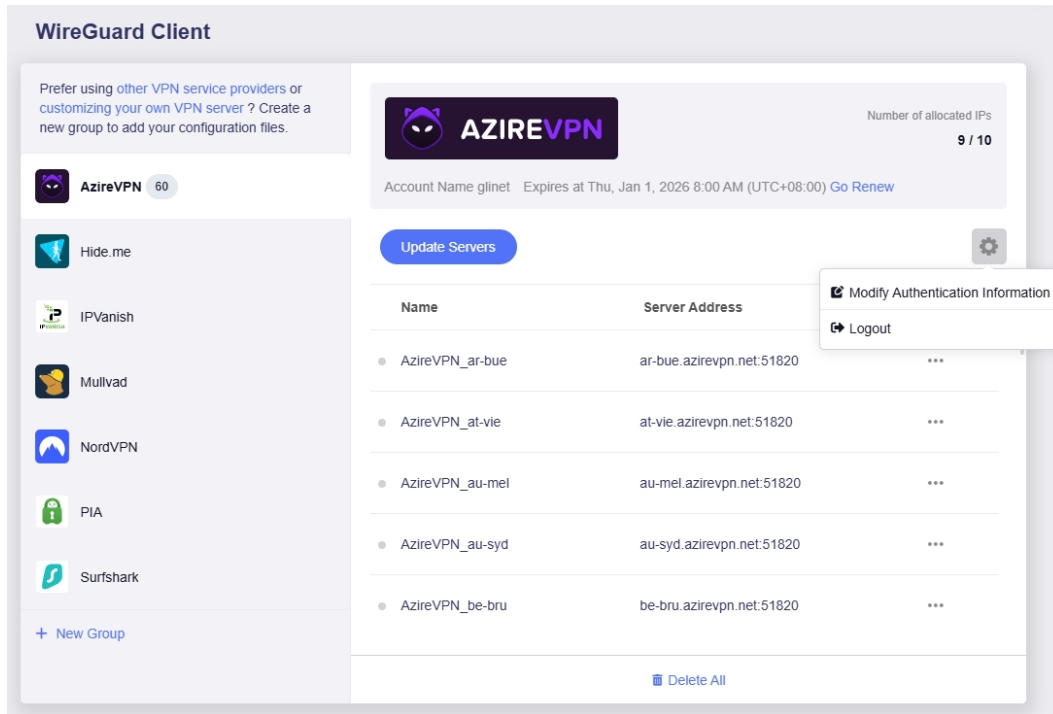

7. Go renew.

If you click **Go Renew**, you will be re-directed to the official website to renew your subscription.

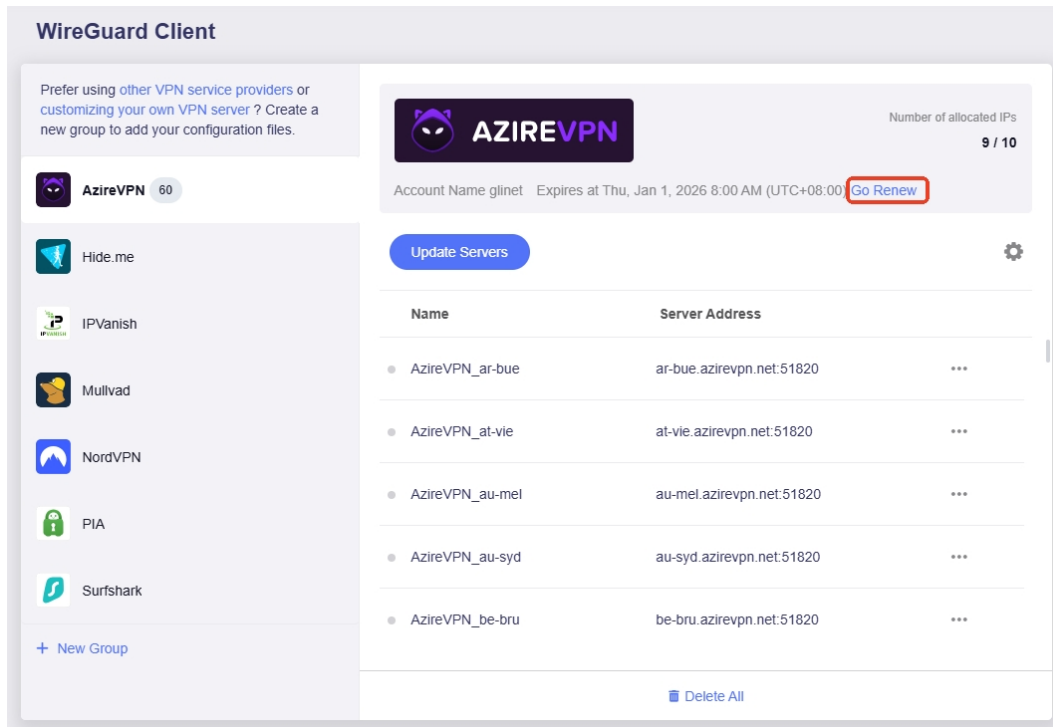

8. Delete all files.

You can click **Delete All** to delete all configuration files with one click, and choose whether to delete the private and public keys simultaneously.

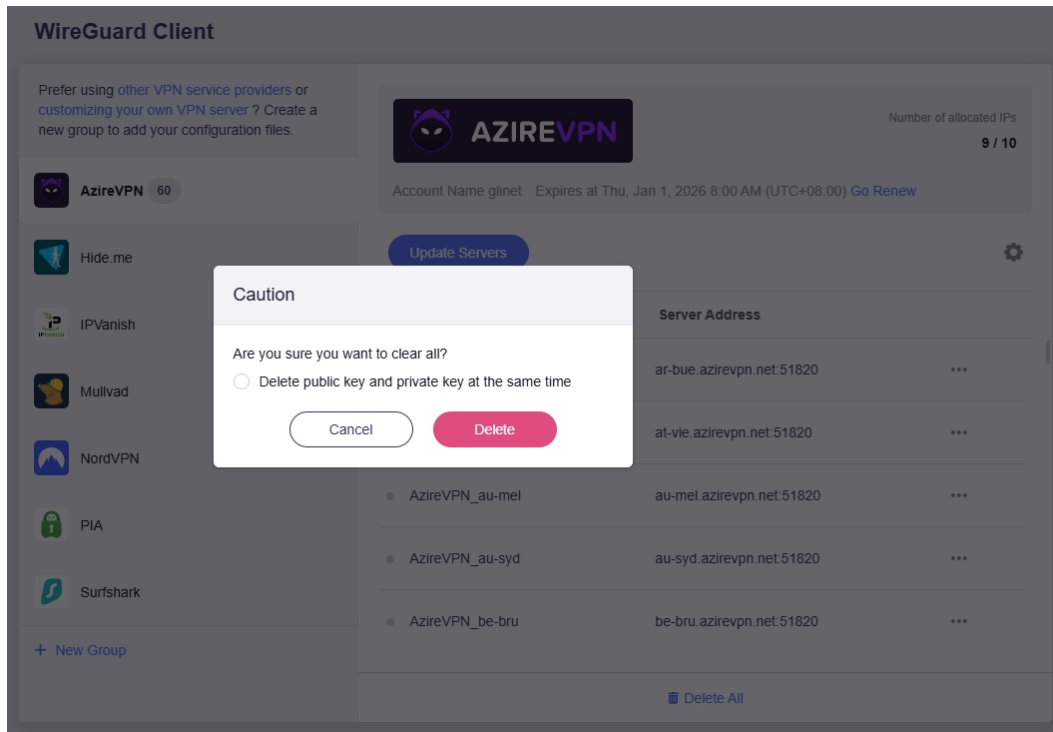

11.2.3 Set Up Hide.me

Follow the steps below to set your router as a Hide.me client.

1. Log in to your router's web admin panel and go to **VPN > WireGuard Client > Hide.me**.
2. Input Username and Password, then click **Save and Continue**. It will generate configuration files for each server.

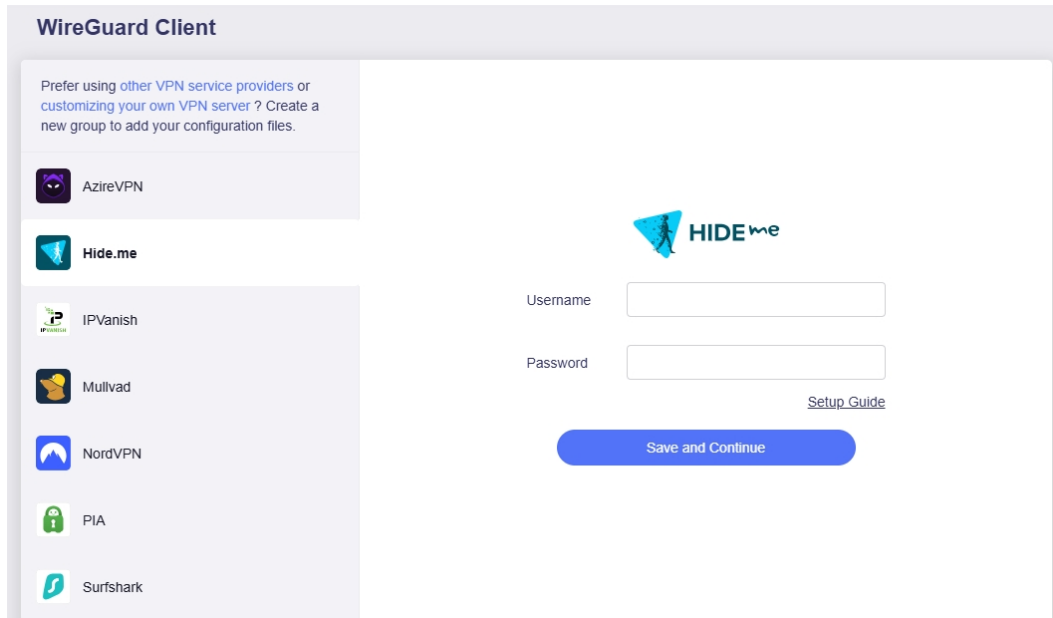

3. Select a preferred server, and click the three-dot icon on the right to start a connection.

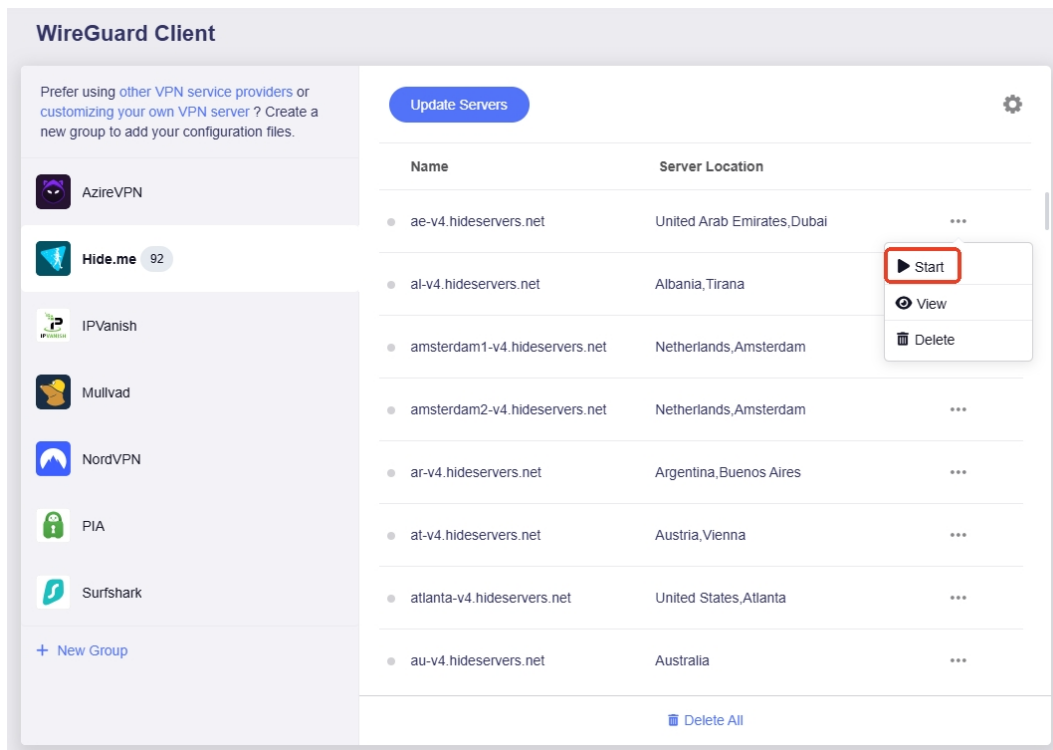

- Once connected, a green dot will appear next to the configuration file.

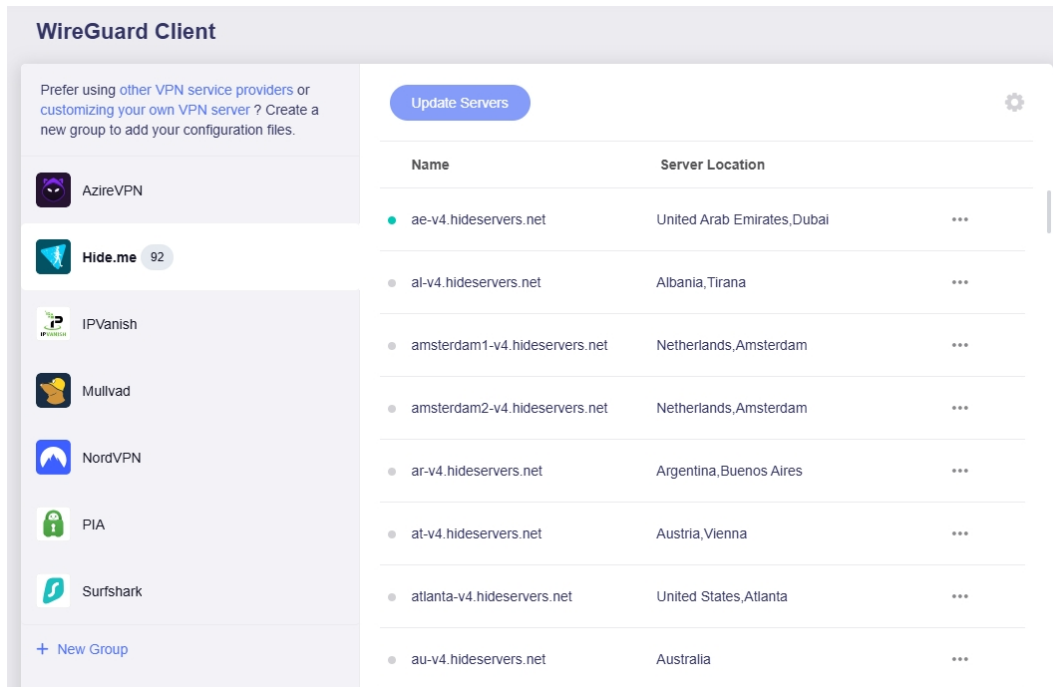

You can also check the VPN connection details on the **VPN Dashboard**.

- Update servers.

You can click **Update Servers** to obtain the latest available server list, avoiding connection failures caused by server maintenance or shutdown.

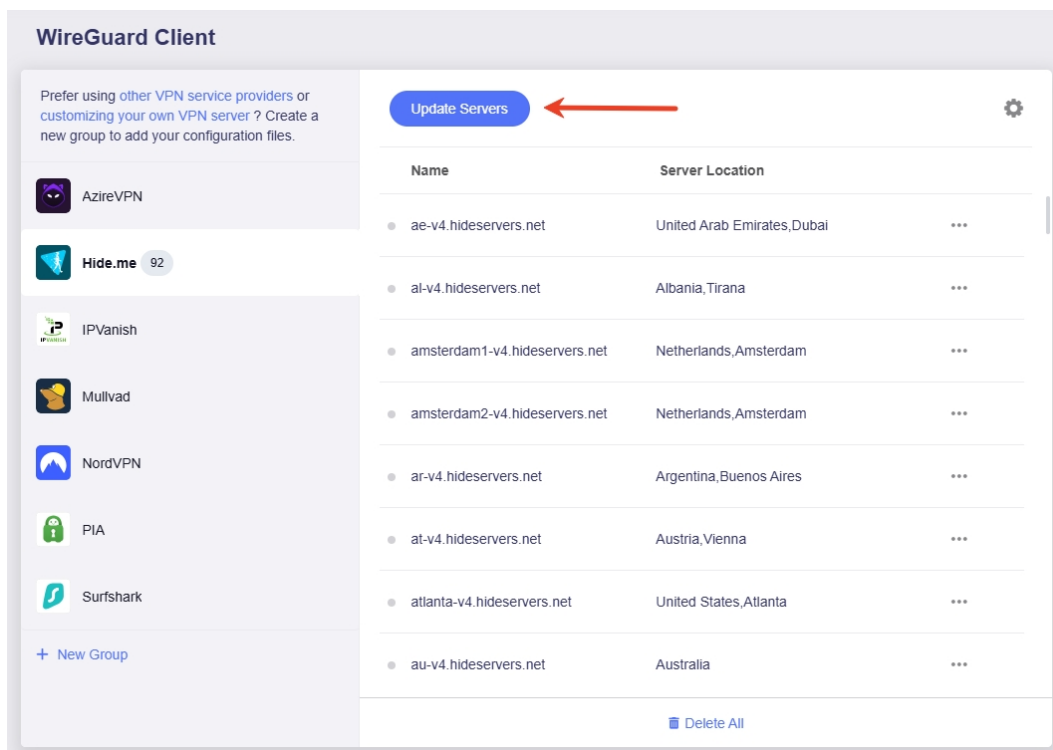

6. Edit credentials or logout.

Click the gear icon to edit your login credentials or log out.

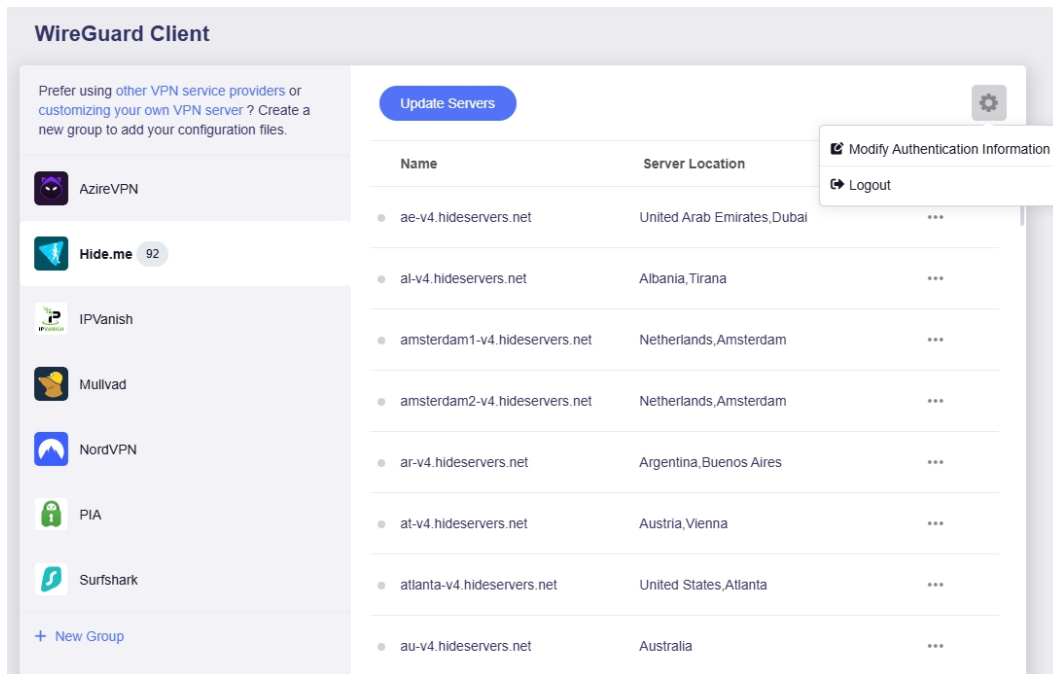

7. Delete all files.

You can click **Delete All** to delete all configuration files with one click, and choose whether to delete the private and public keys simultaneously.

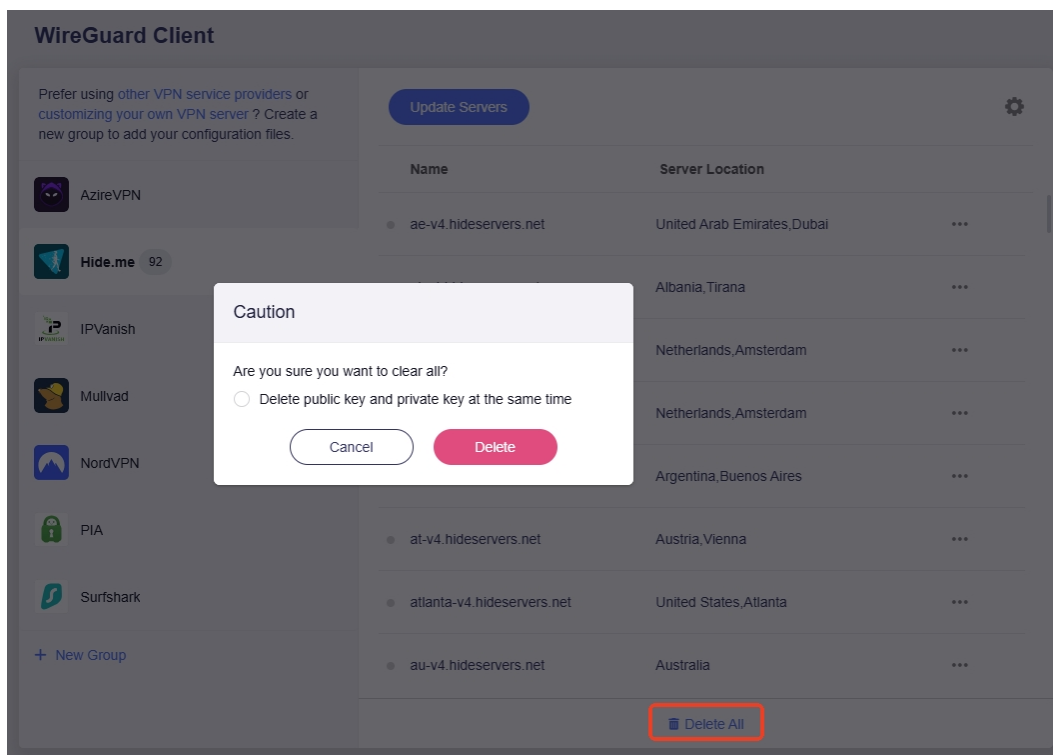

11.2.4 Set Up IPVanish

Follow the steps below to set your router as an IPVanish client.

1. Log in to your router's web admin panel and go to **VPN > WireGuard Client > IPVanish**.
2. Input Username and Password, then click **Save and Continue**.

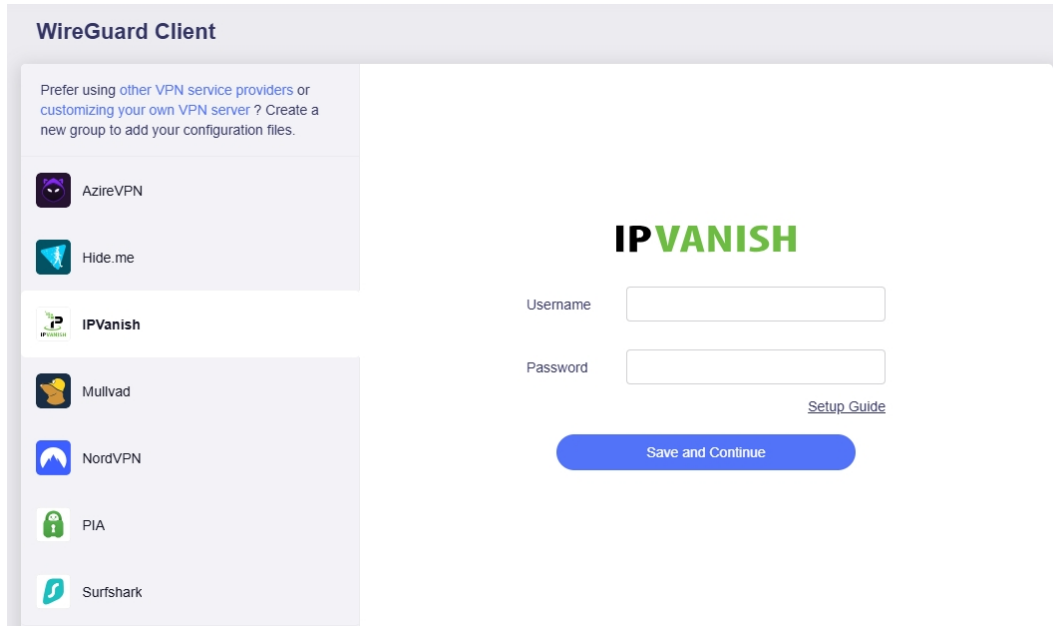

3. Select the server(s) you want to connect to, and click **Apply**.

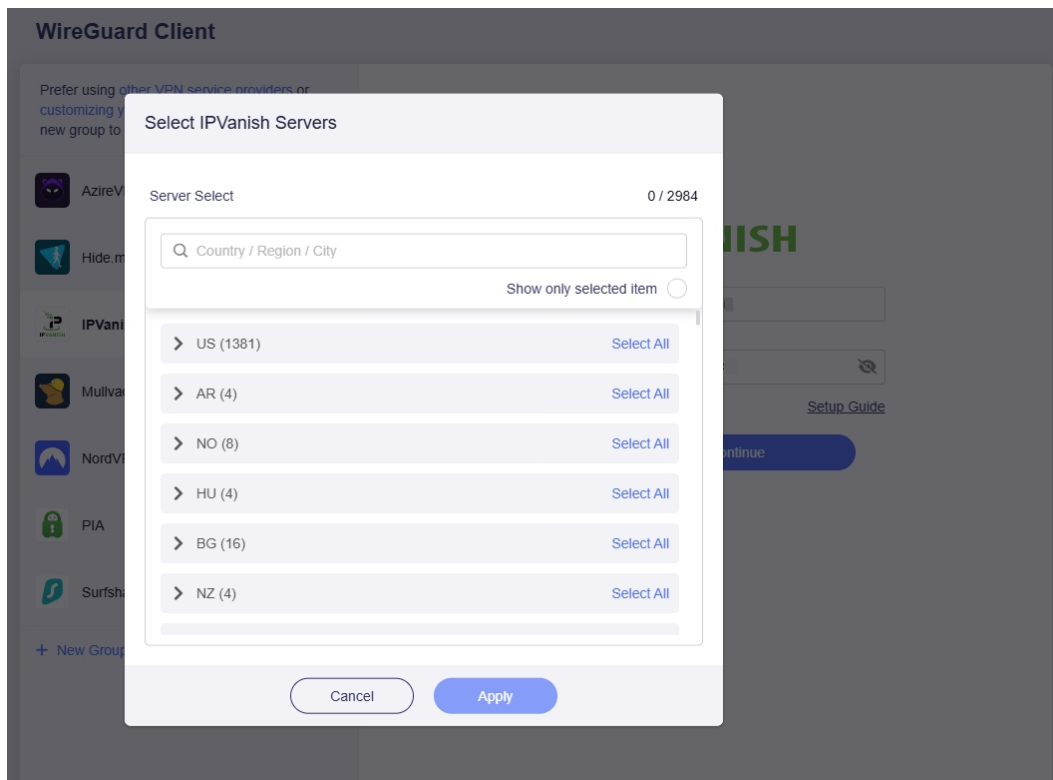

4. Select a preferred server, and click the three-dot icon on the right to start a connection.

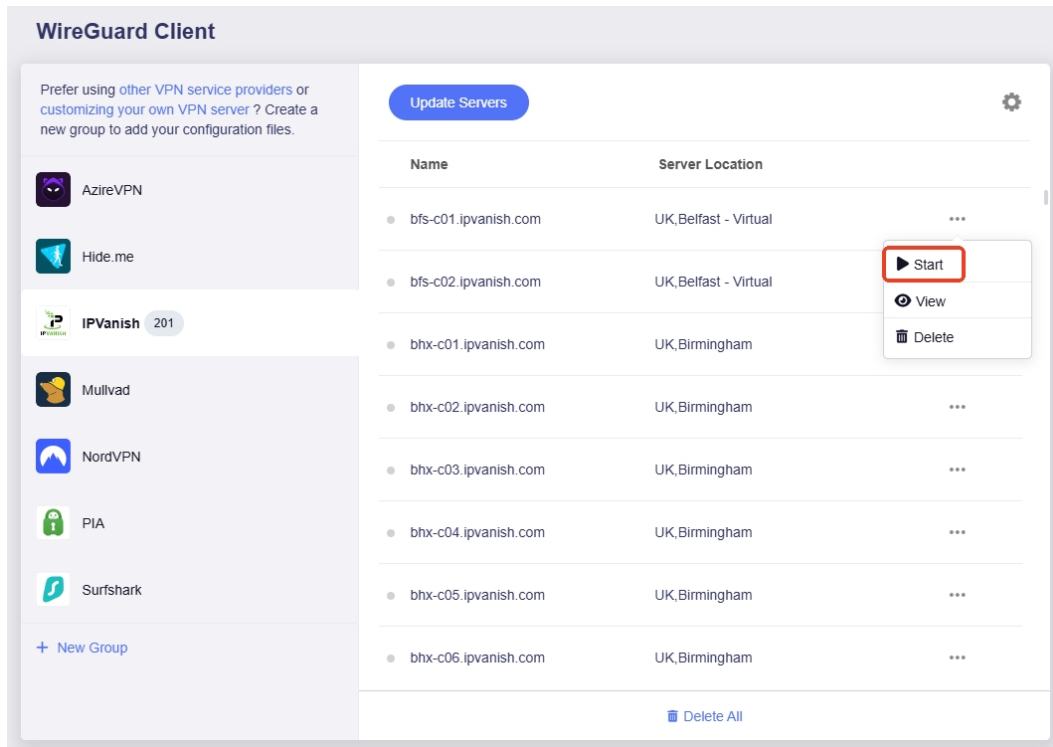

5. Once connected, a green dot will appear next to the configuration file.

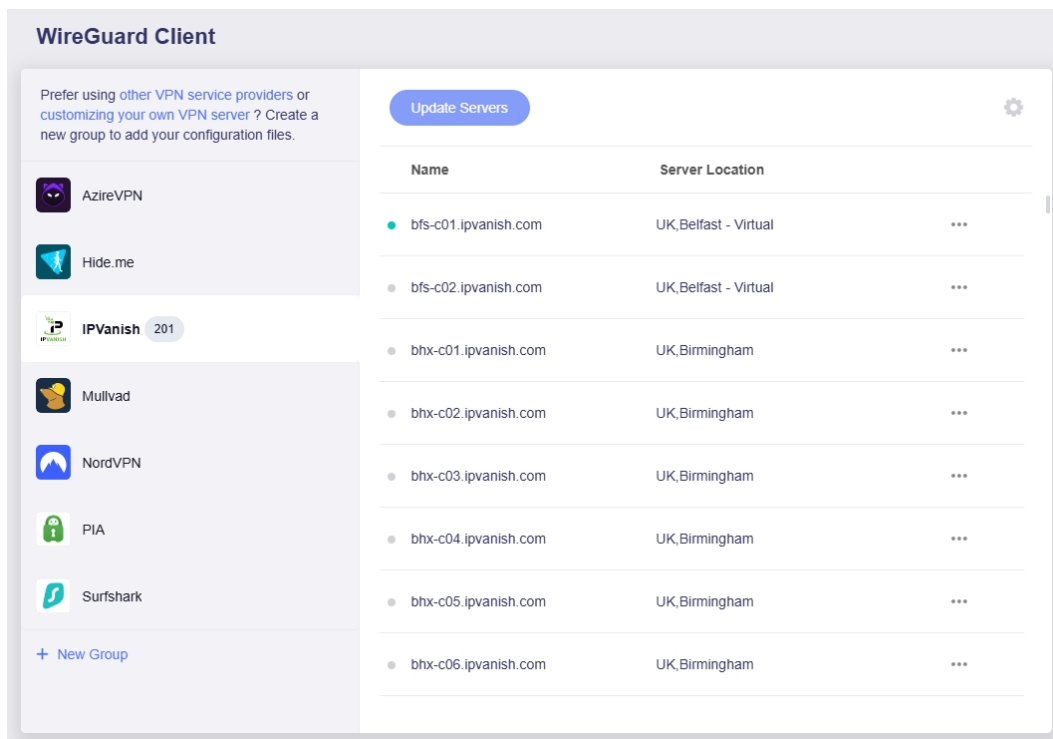

You can also check the VPN connection details on the **VPN Dashboard**.

6. Update servers.

You can click **Update Servers** to obtain the latest available server list, avoiding connection failures caused by server maintenance or shutdown.

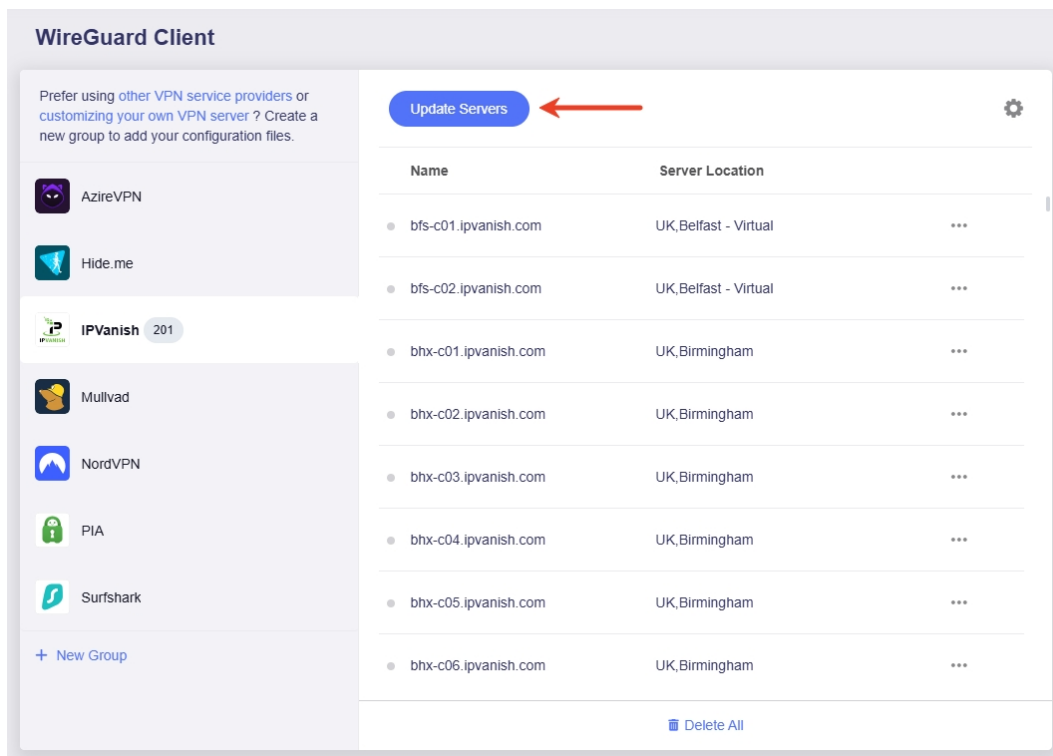

7. Edit credentials or logout.

Click the gear icon to edit your login credentials or log out.

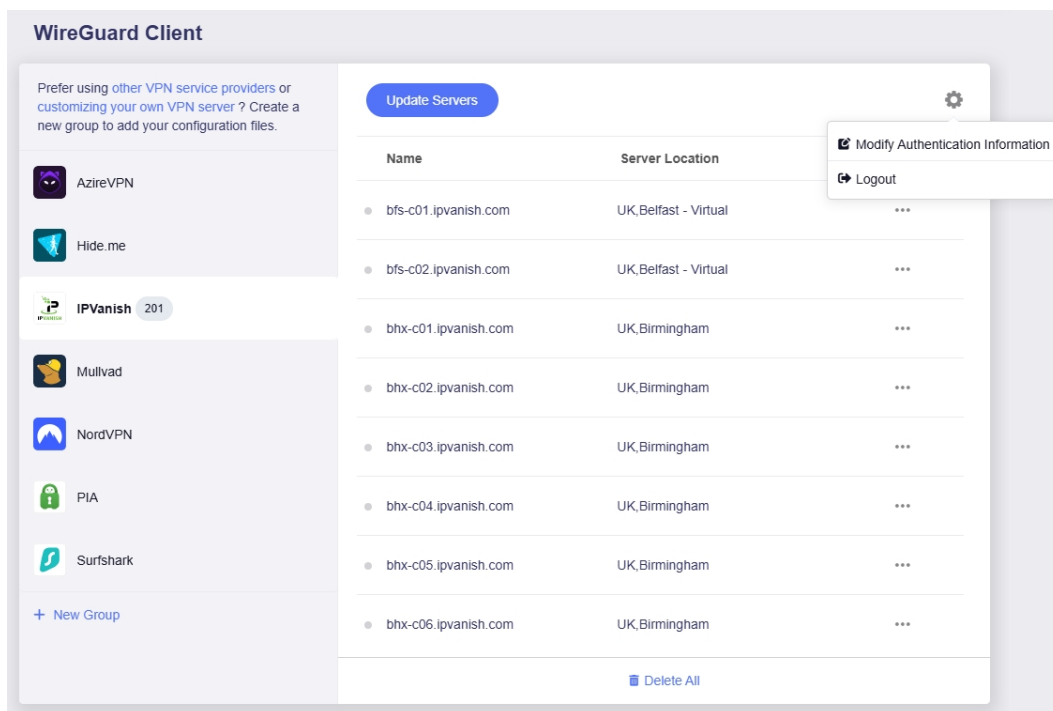

8. Delete all files.

You can click **Delete All** to delete all configuration files with one click, and choose whether to delete the private and public keys simultaneously.

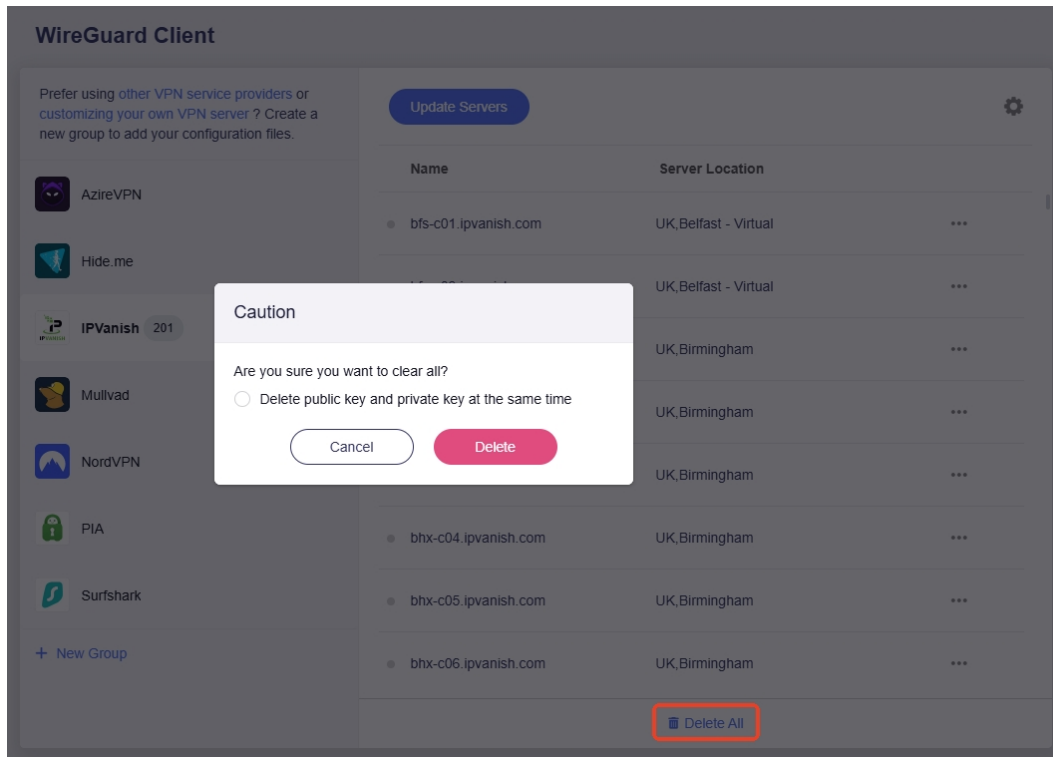

11.2.5 Set Up Mullvad

Follow the steps below to set your router as a Mullvad client.

1. Log in to your router's web admin panel and go to **VPN > WireGuard Client > Mullvad**.
2. Input Username and Password, then click **Save and Continue**.

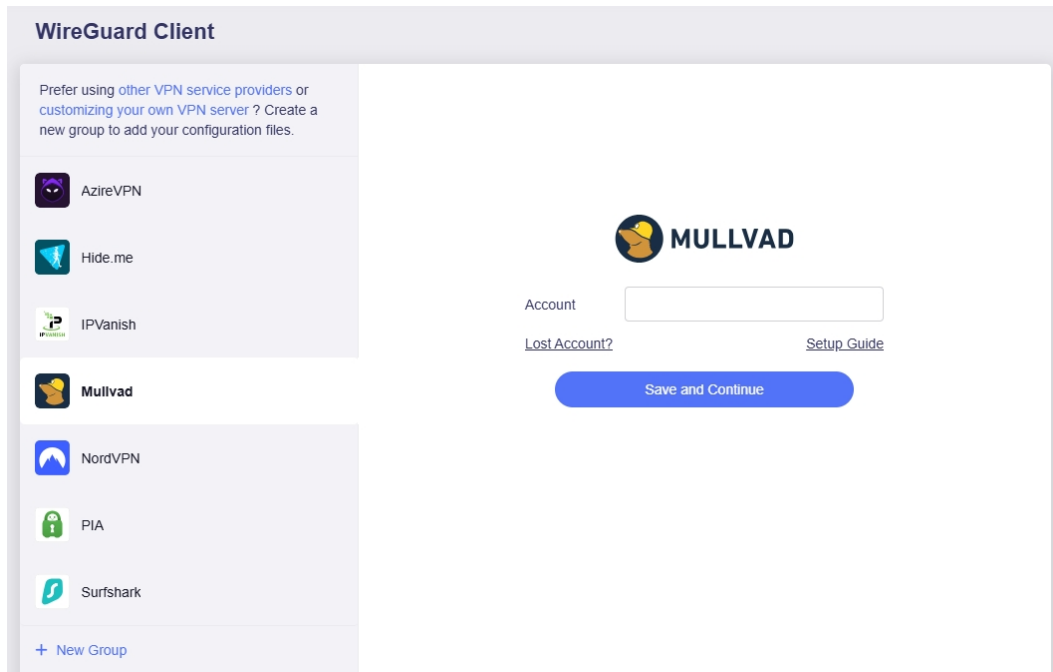

3. Select the server(s) you want to connect to, and click **Apply**.

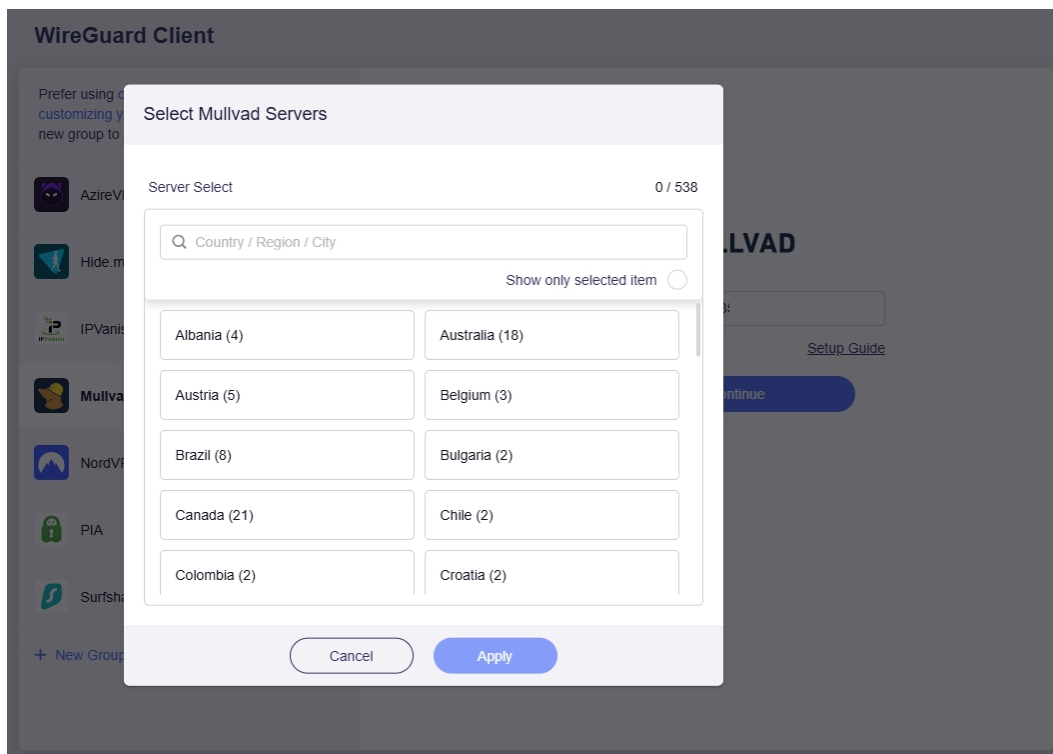

4. Select a preferred server, and click the three-dot icon on the right to start a connection.

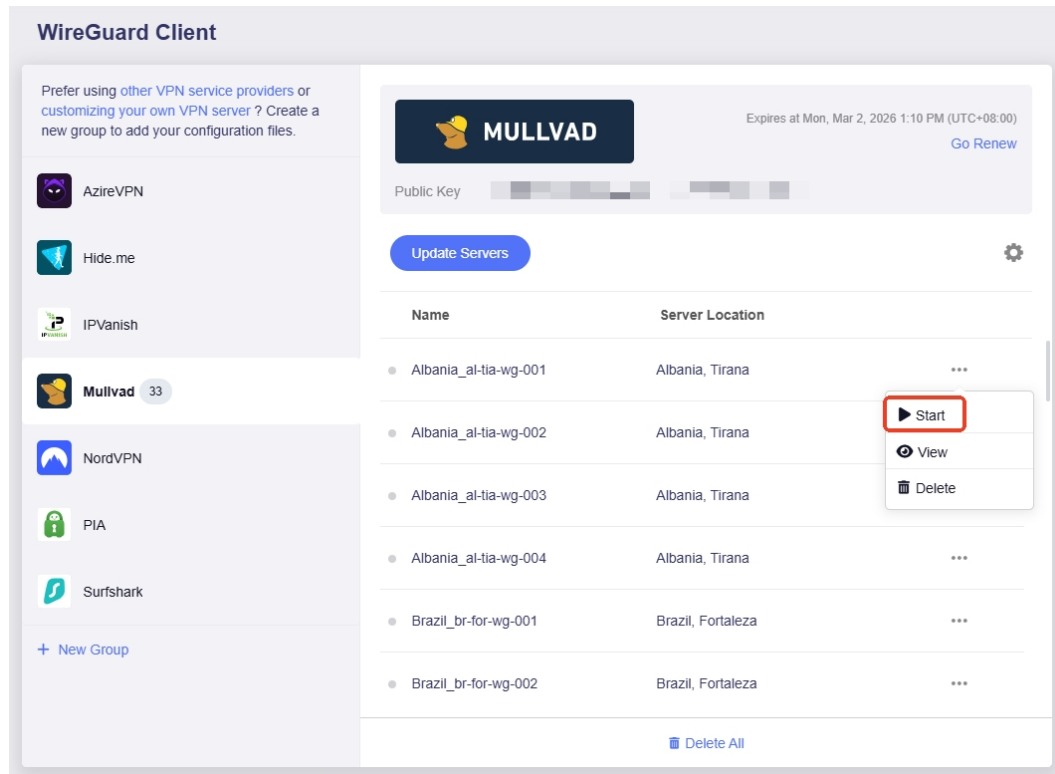

5. Once connected, a green dot will appear next to the configuration file.

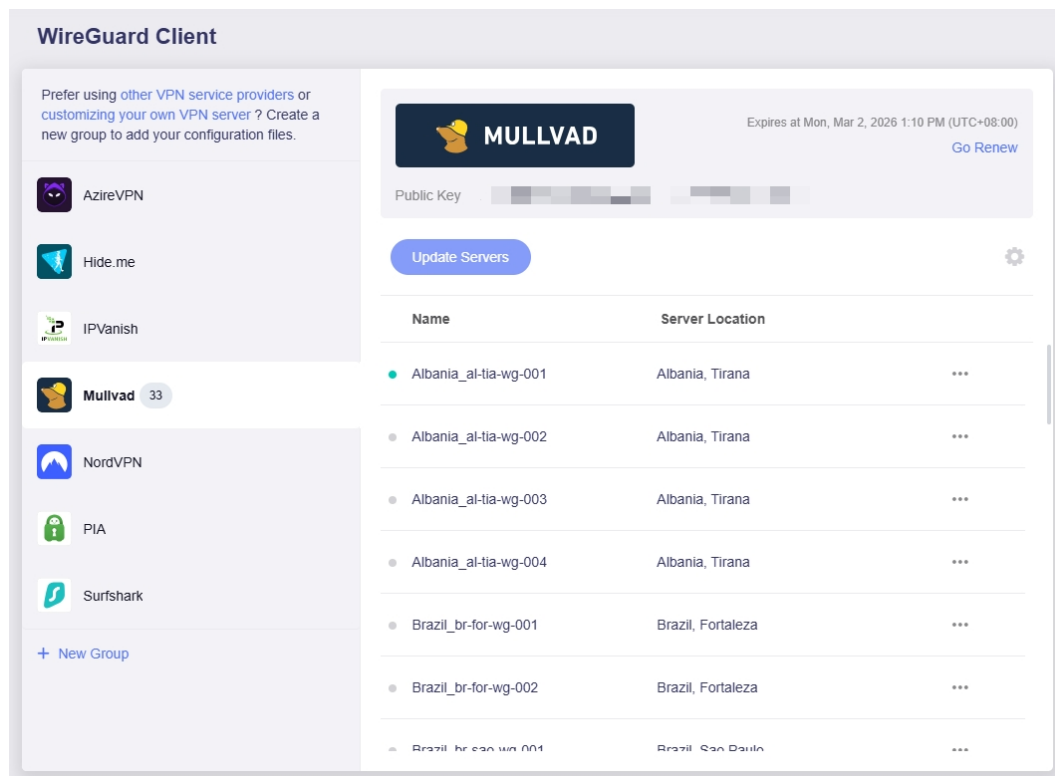

You can also check the VPN connection details on the **VPN Dashboard**.

6. Update servers.

You can click **Update Servers** to obtain the latest available server list, avoiding connection failures caused by server maintenance or shutdown.

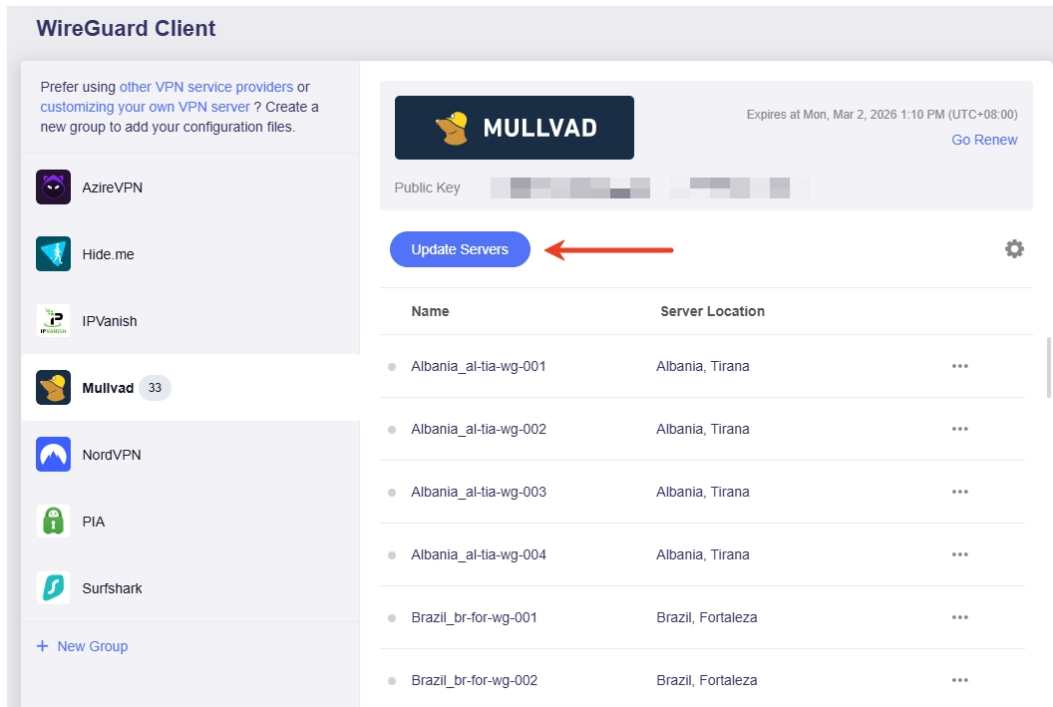

7. Edit credentials or logout.

Click the gear icon to edit your login credentials or log out.

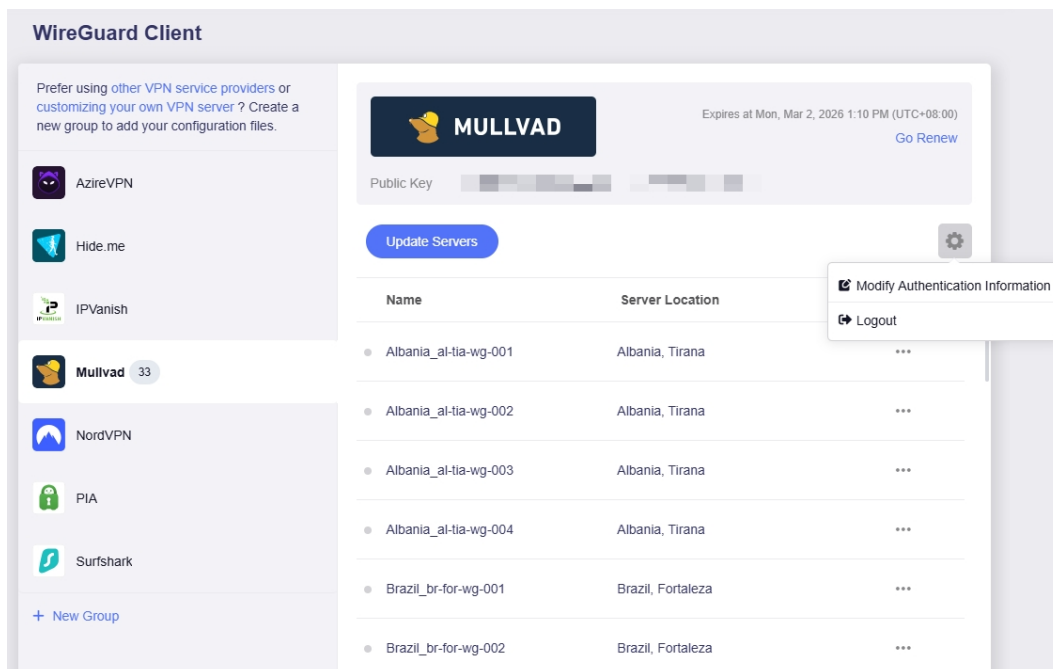

8. Go renew.

If you click **Go Renew**, you will be re-directed to the official website to renew your subscription.

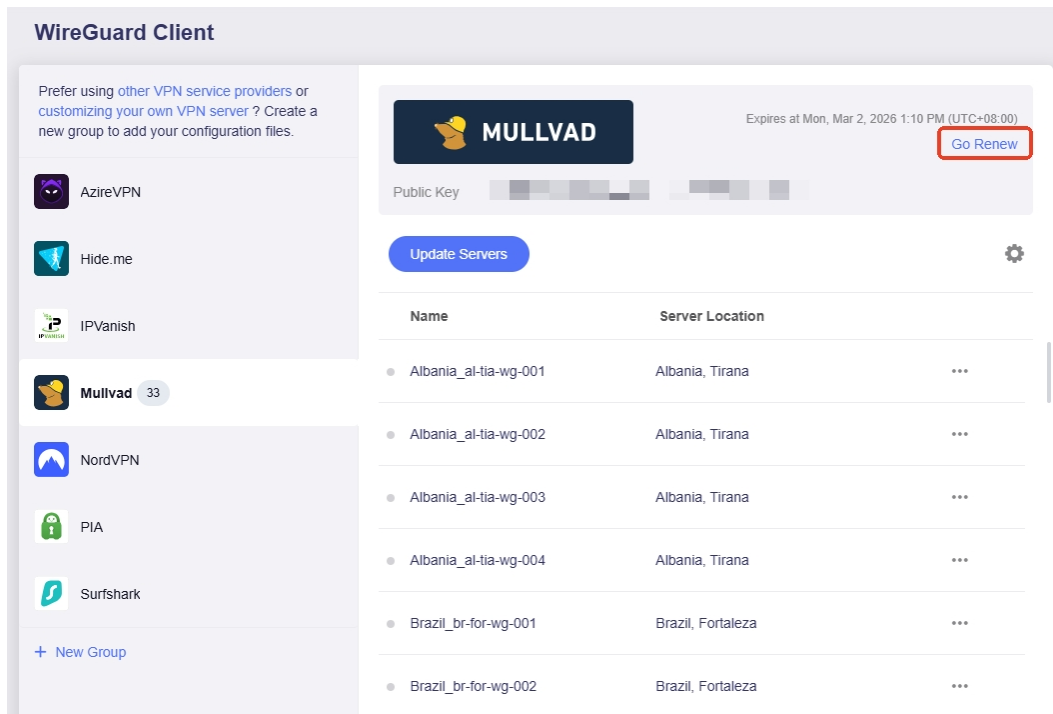

9. Delete all files.

You can click **Delete All** to delete all configuration files with one click, and choose whether to delete the private and public keys simultaneously.

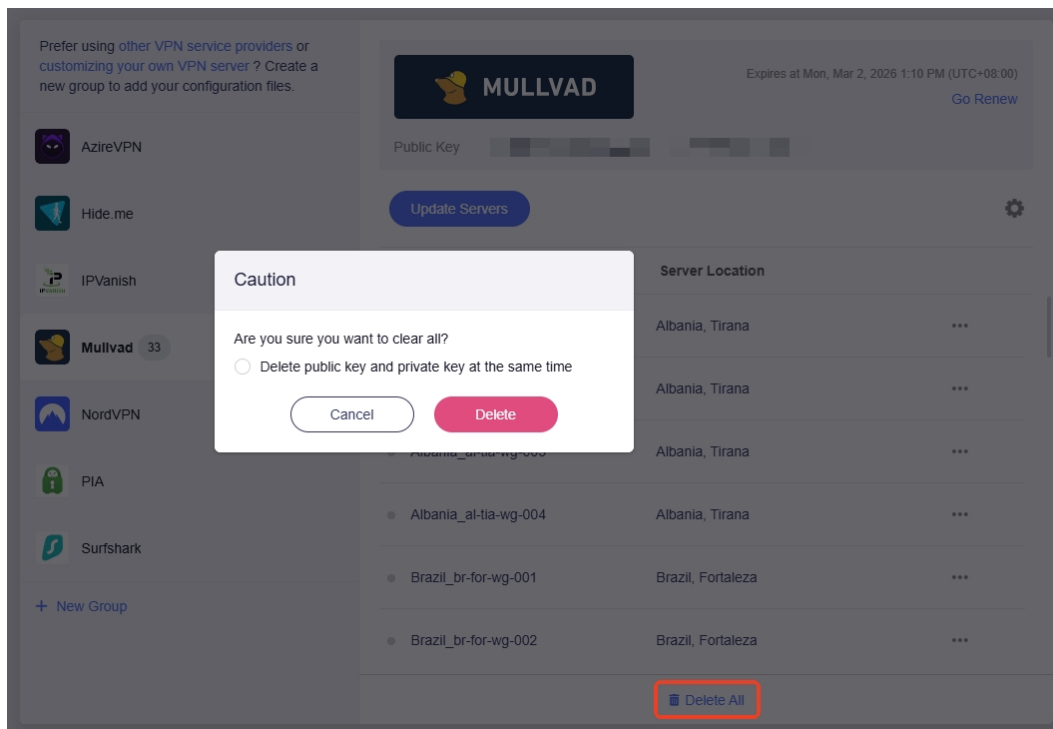

11.2.6 Set Up NordVPN

Follow the steps below to set your router as a NordVPN client.

1. Log in to your NordVPN web account [here](#).
2. On the Nord Dashboard, click **NordVPN**, then click **Set up NordVPN manually**.

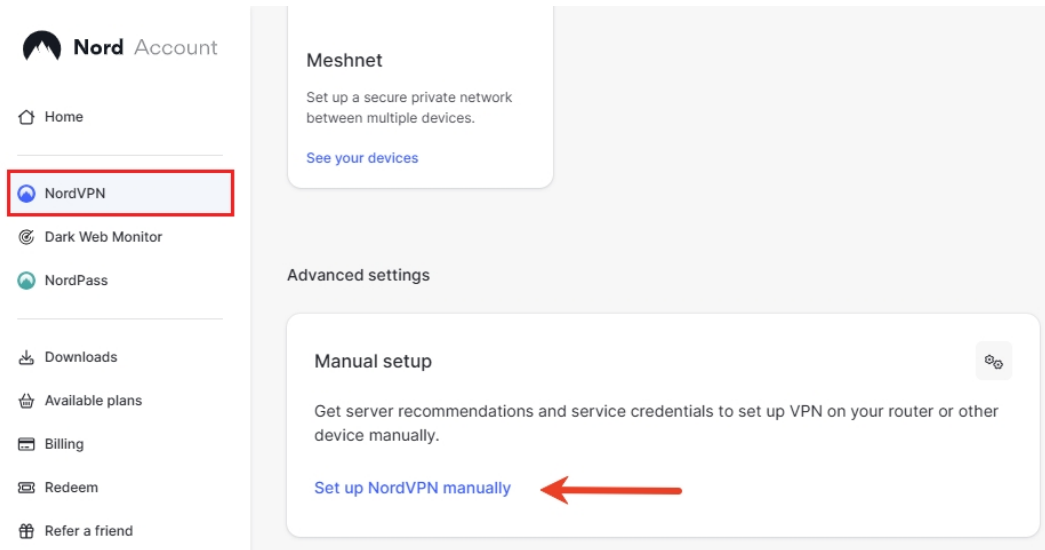

You will find the **Access Token**. Create an access token and copy for later use.

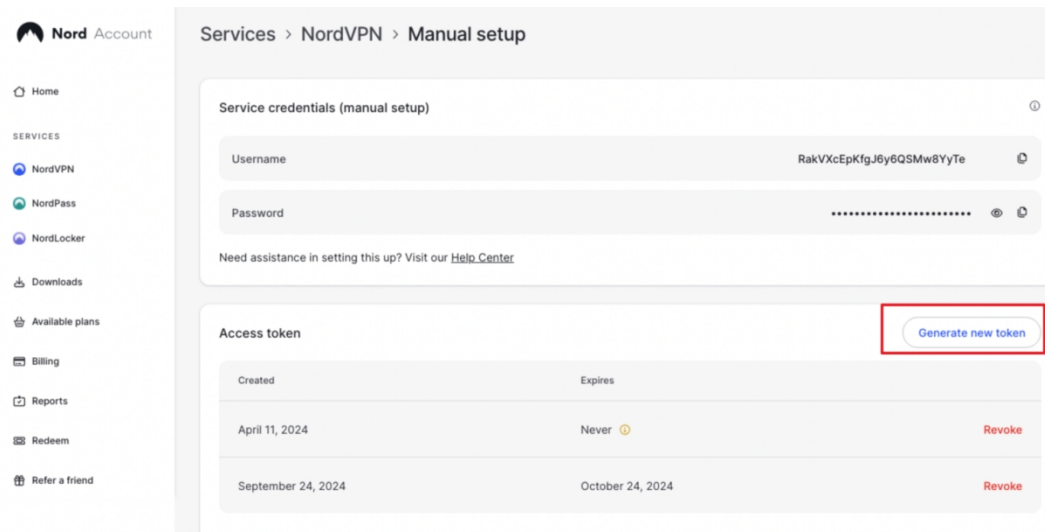

3. Log in to your router's web admin panel and go to **VPN > WireGuard Client > NordVPN**.
4. Input token, and click **Save and Continue**.

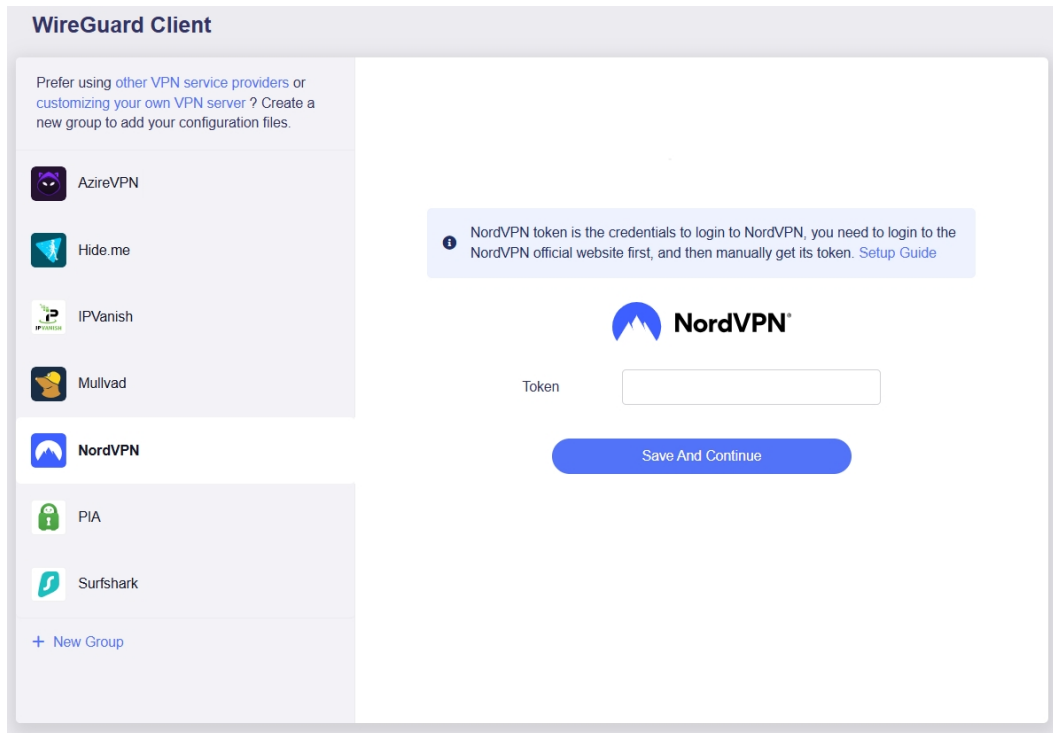

5. Select the server(s) you want to connect to, and click **Apply**.

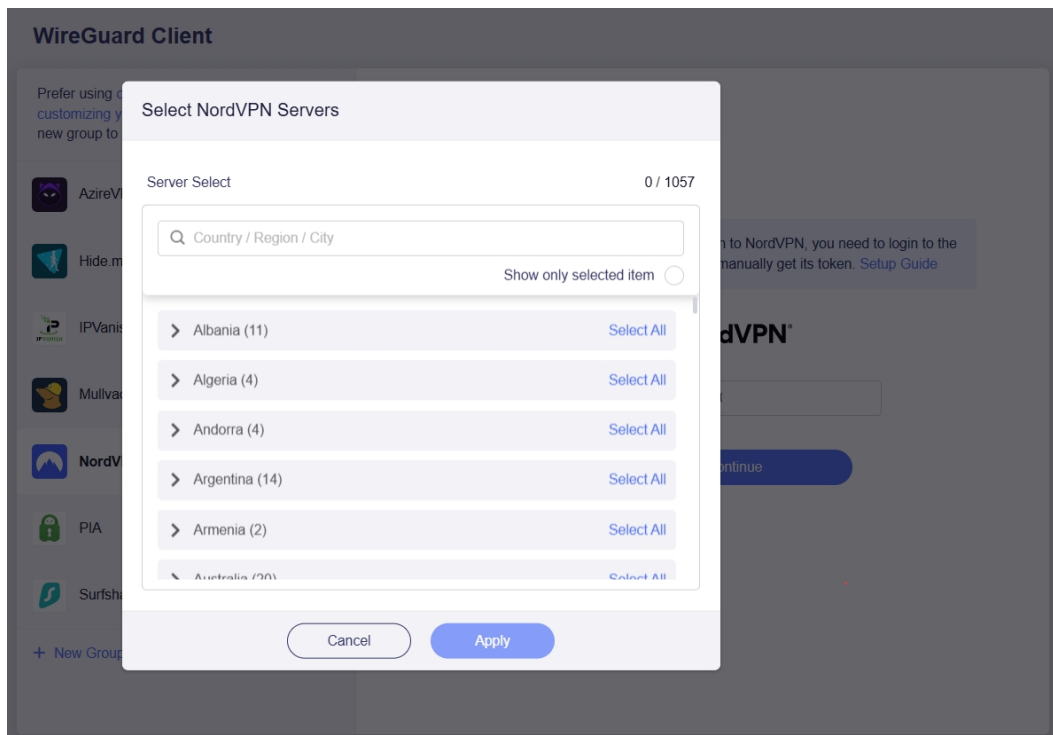

6. Select a preferred server, and click the three-dot icon on the right to start a connection.

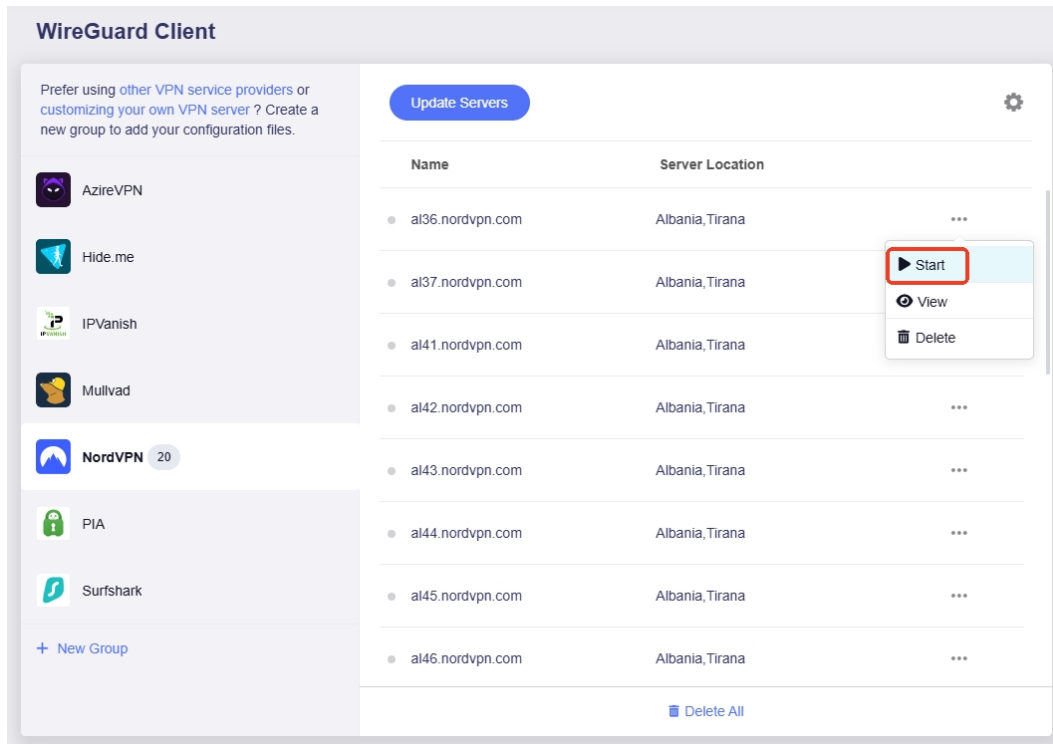

7. Once connected, a green dot will appear next to the configuration file.

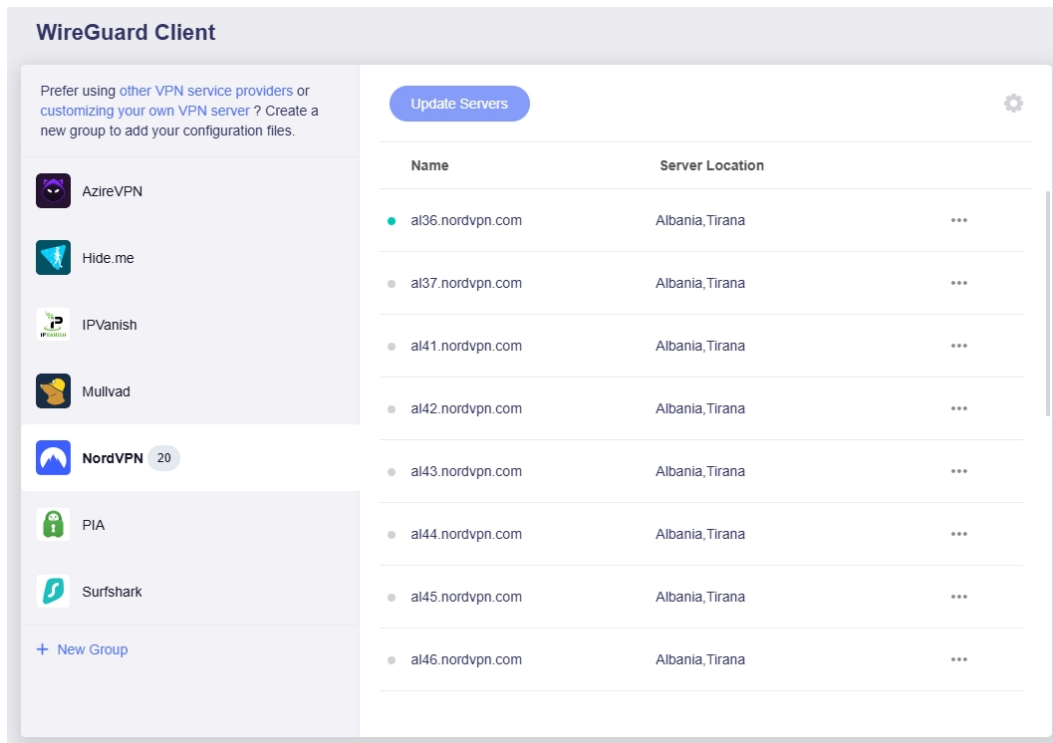

You can also check the VPN connection details on the **VPN Dashboard**.

8. Update servers.

You can click **Update Servers** to obtain the latest available server list, avoiding connection failures caused by server maintenance or shutdown.

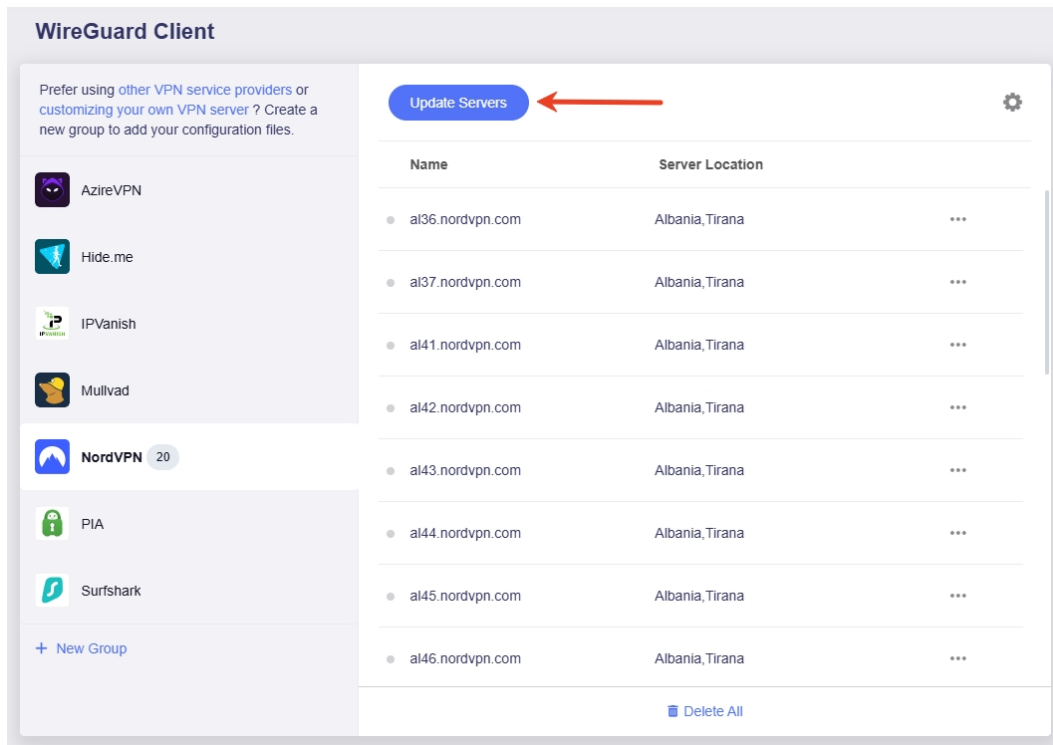

9. Edit credentials or logout.

Click the gear icon to edit your login credentials or log out.

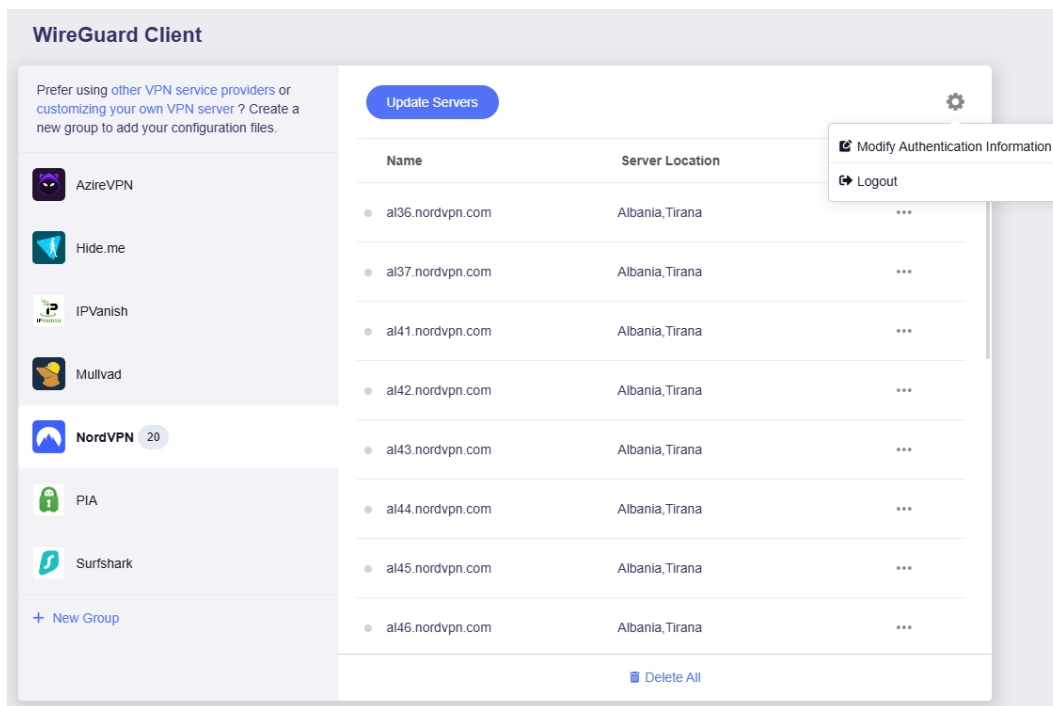

10. Delete all files.

You can click **Delete All** to delete all configuration files with one click, and choose whether to delete the private and public keys simultaneously.

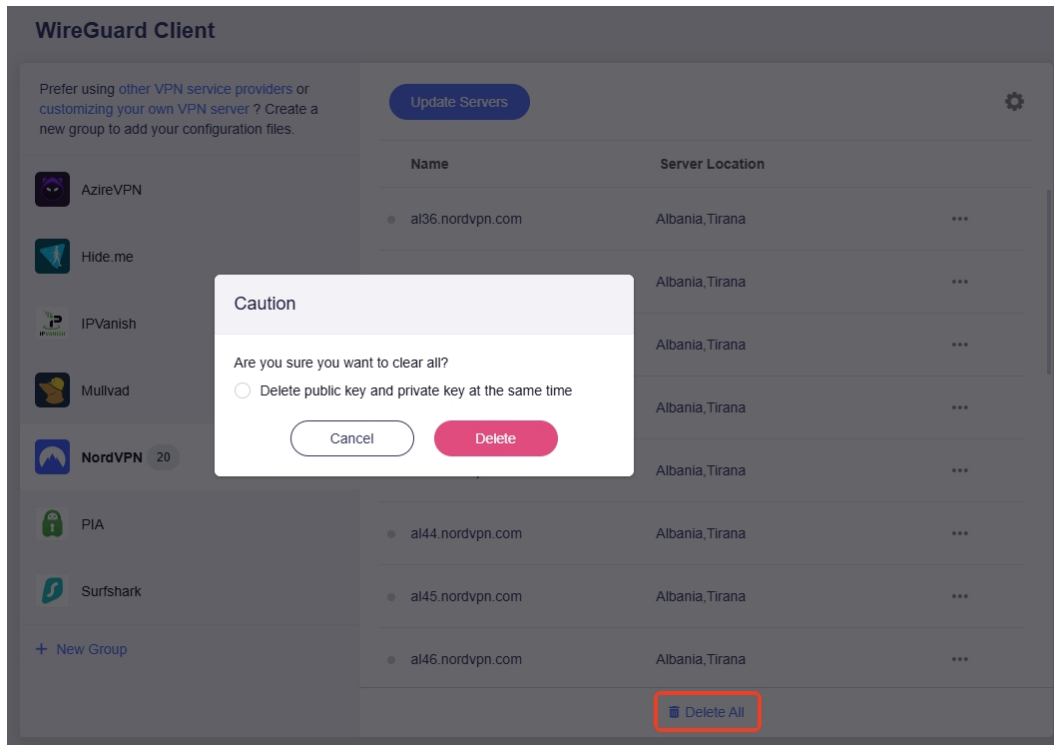

11.2.7 Set Up PIA (Private Internet Access)

Follow the steps below to set your router as a PIA client.

1. Log in to your router's web admin panel and go to **VPN > WireGuard Client > PIA**.
2. Input Username and Password, then click **Save and Continue**.

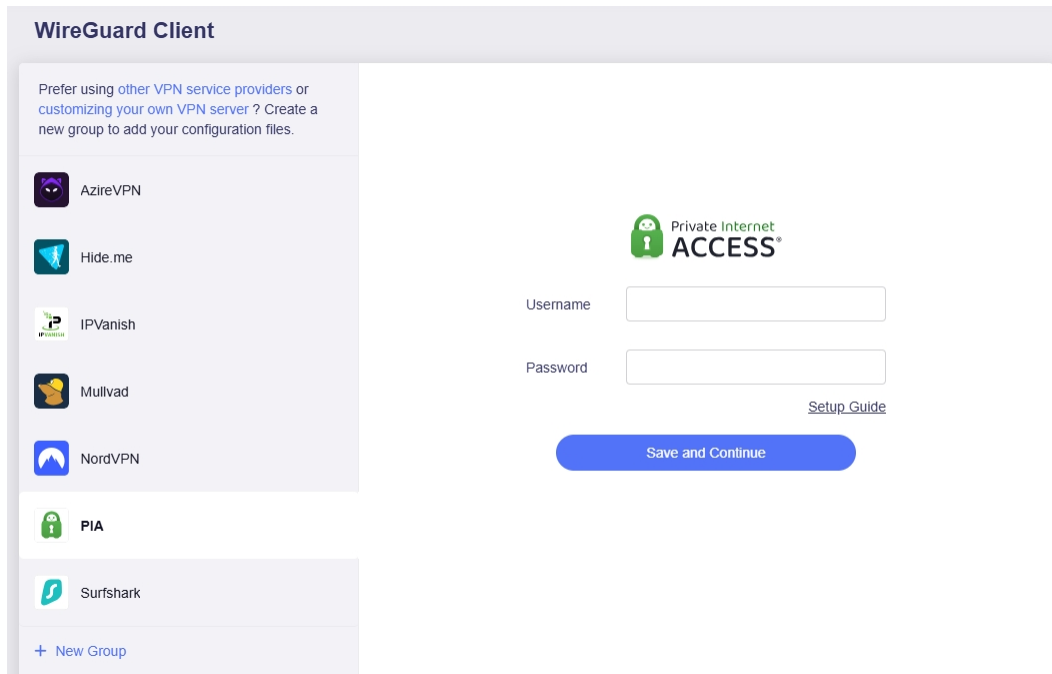

The screenshot shows the 'WireGuard Client' configuration interface. On the left, there is a list of VPN providers: AzureVPN, Hide.me, IPVanish, Mullvad, NordVPN, PIA (highlighted), and Surfshark, with a '+ New Group' option at the bottom. The main area displays the PIA logo and the text 'Private Internet ACCESS'. Below the logo are two input fields: 'Username' and 'Password'. A 'Setup Guide' link is located below the password field. At the bottom center, there is a blue 'Save and Continue' button.

3. Select the server(s) you want to connect to, and click **Apply**.

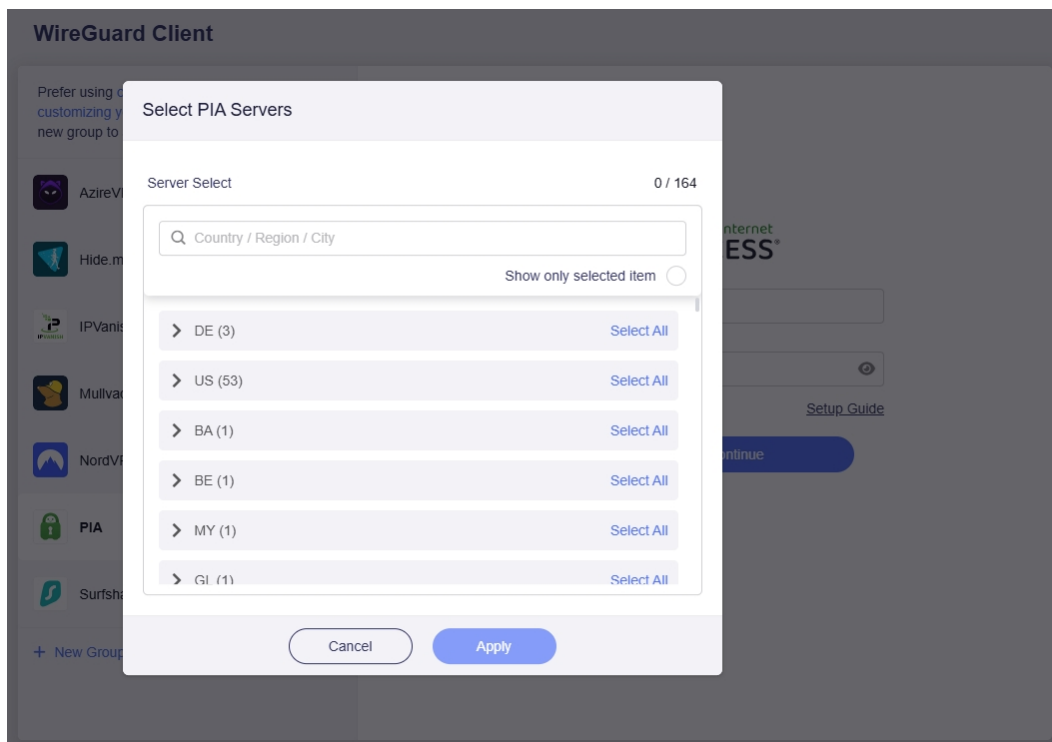

The screenshot shows a 'Select PIA Servers' dialog box overlaid on the configuration page. The dialog has a title bar 'Select PIA Servers' and a subtitle 'Server Select' with a count '0 / 164'. It features a search bar labeled 'Country / Region / City' and a toggle for 'Show only selected item'. Below the search bar, there is a list of server groups with expandable arrows and 'Select All' links: DE (3), US (53), BA (1), BE (1), MY (1), and GI (1). At the bottom of the dialog are 'Cancel' and 'Apply' buttons.

4. Select a preferred server, and click the three-dot icon on the right to start a connection.

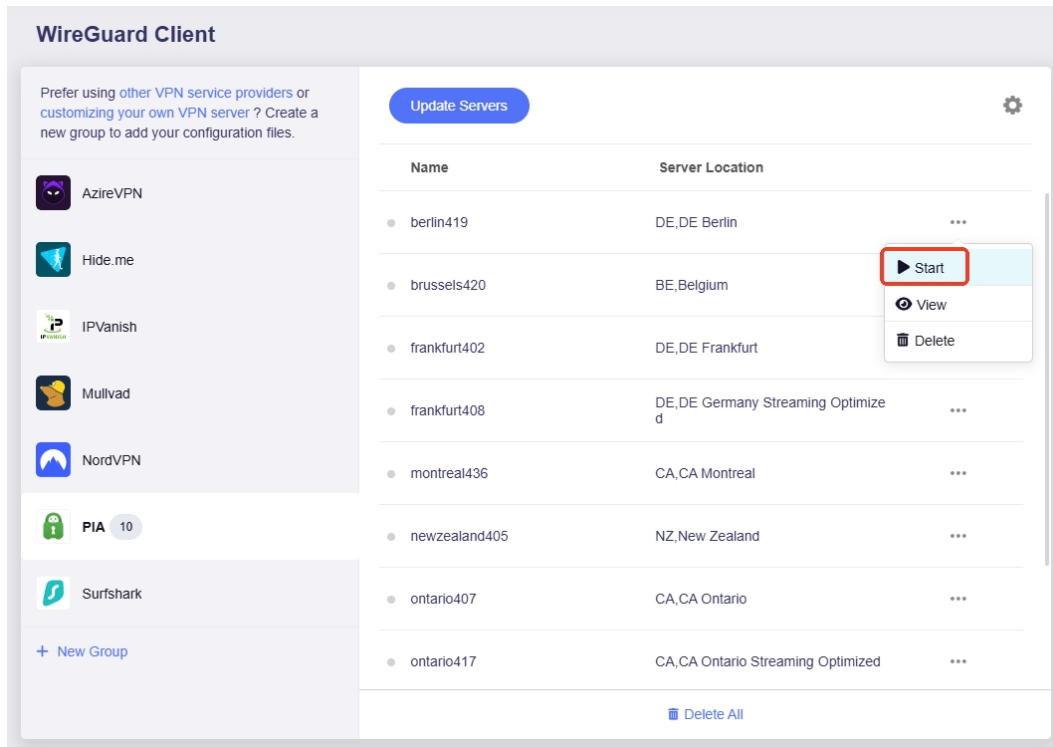

5. Once connected, a green dot will appear next to the configuration file.

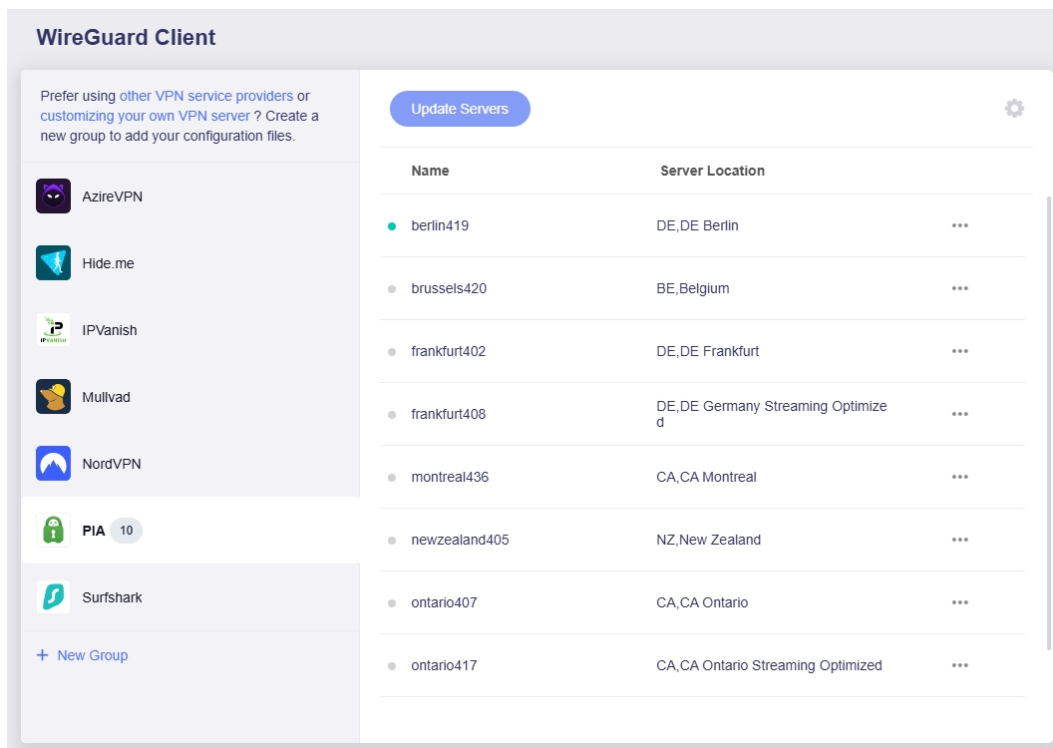

You can also check the VPN connection details on the **VPN Dashboard**.

6. Update servers.

You can click **Update Servers** to obtain the latest available server list, avoiding connection failures caused by server maintenance or shutdown.

The screenshot shows the WireGuard Client interface. On the left, there is a sidebar with various VPN providers: AzireVPN, Hide.me, IPVanish, Mullvad, NordVPN, PIA (with a '10' badge), and Surfshark. Below these is a '+ New Group' button. The main area contains a blue 'Update Servers' button with a red arrow pointing to it. To the right of this button is a gear icon. Below the button is a table of servers with columns for 'Name' and 'Server Location'. The table lists several servers with their respective locations and a three-dot menu icon for each. At the bottom of the table is a 'Delete All' button.

Name	Server Location
berlin419	DE,DE Berlin
brussels420	BE,Belgium
frankfurt402	DE,DE Frankfurt
frankfurt408	DE,DE Germany Streaming Optimized
montreal436	CA,CA Montreal
newzealand405	NZ,New Zealand
ontario407	CA,CA Ontario
ontario417	CA,CA Ontario Streaming Optimized

7. Edit credentials or logout.

Click the gear icon to edit your login credentials or log out.

This screenshot shows the same WireGuard Client interface as the previous one, but with the gear icon menu open. The menu contains two options: 'Modify Authentication Information' and 'Logout'. The 'Update Servers' button and the server table are still visible in the background.

8. Delete all files.

You can click **Delete All** to delete all configuration files with one click, and choose whether to delete the private and public keys simultaneously.

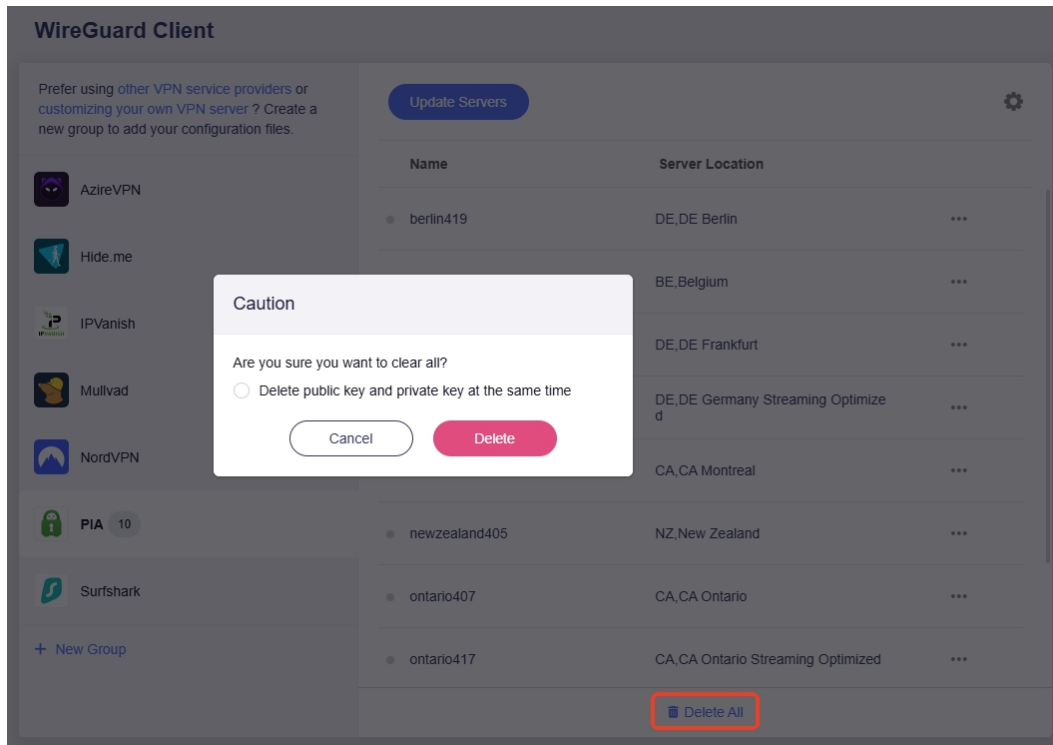

11.2.8 Set Up PureVPN

Follow the steps below to set your router as a PureVPN client.

1. Log in to your router's web admin panel and go to **VPN > WireGuard Client > PureVPN**.
2. Input Username and Password, then click **Save and Continue**. It will generate configuration files for each server.

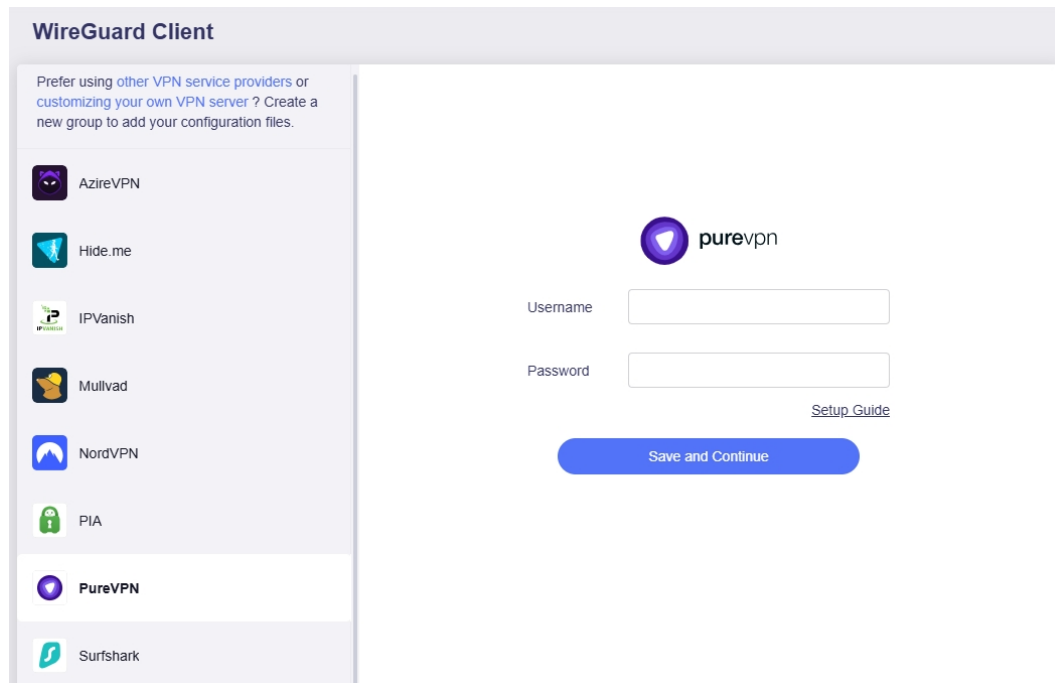

3. Select your preferred server, and click the three-dot icon on the right to start a connection.

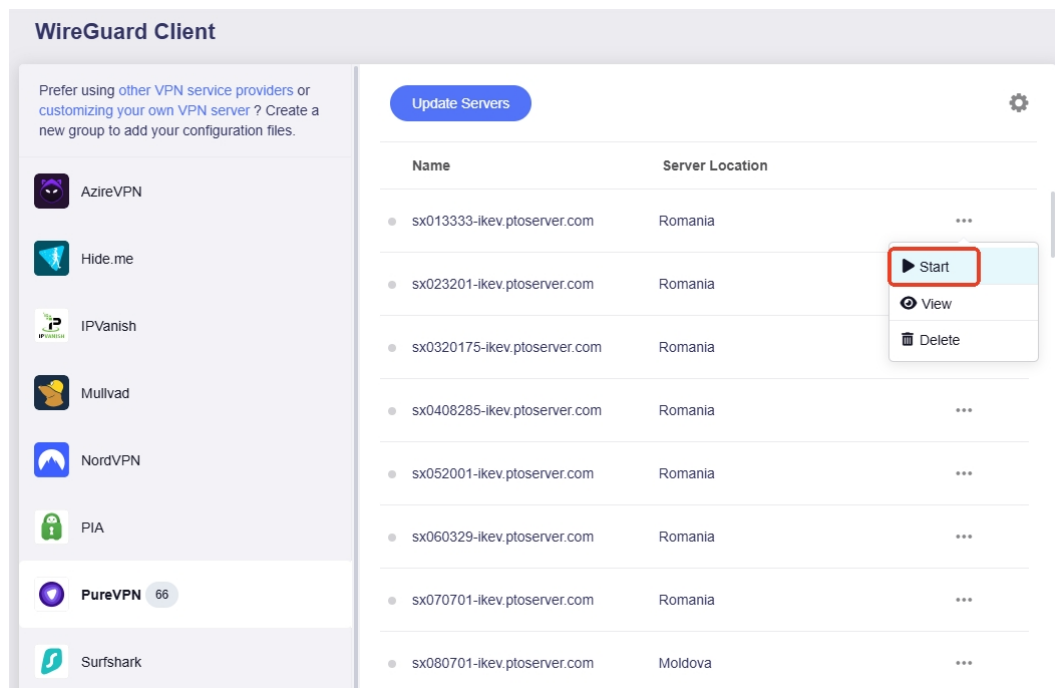

- Once connected, a green dot will appear next to the configuration file.

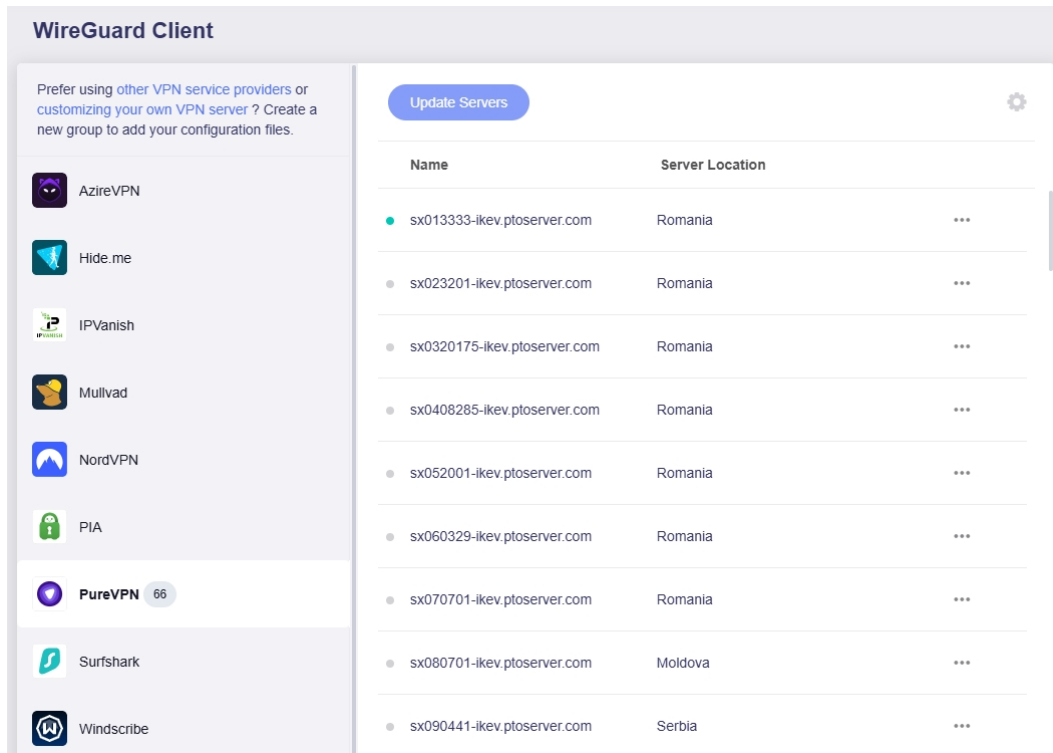

You can also check the VPN connection details on the **VPN Dashboard**.

- Update servers.

You can click **Update Servers** to obtain the latest available server list, avoiding connection failures caused by server maintenance or shutdown.

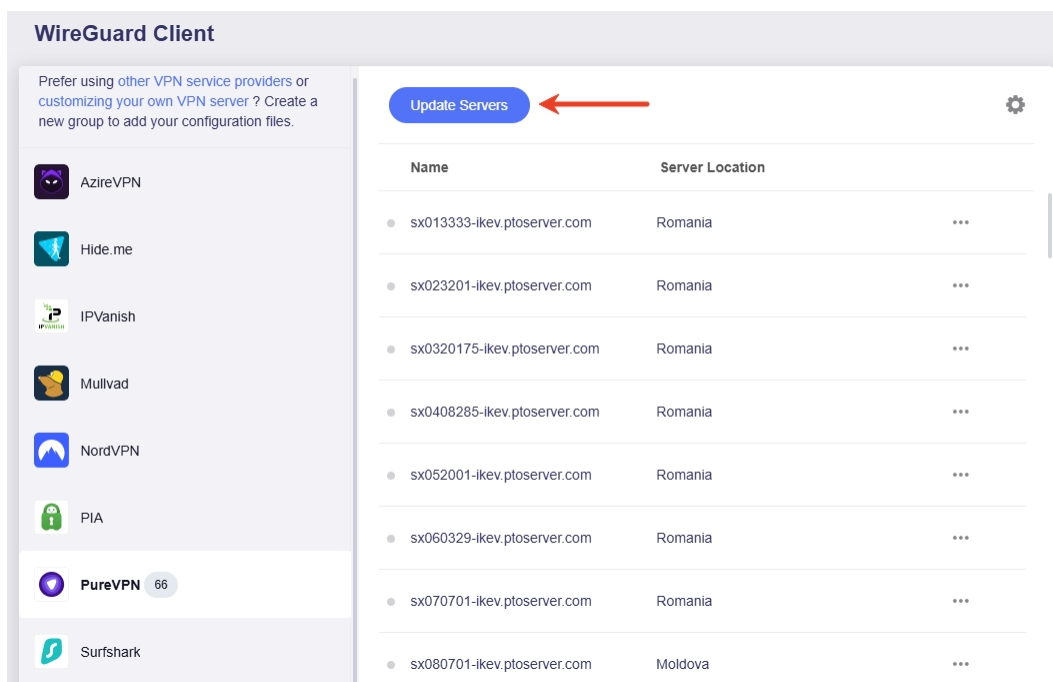

6. Edit credentials or logout.

Click the gear icon to edit your login credentials or log out.

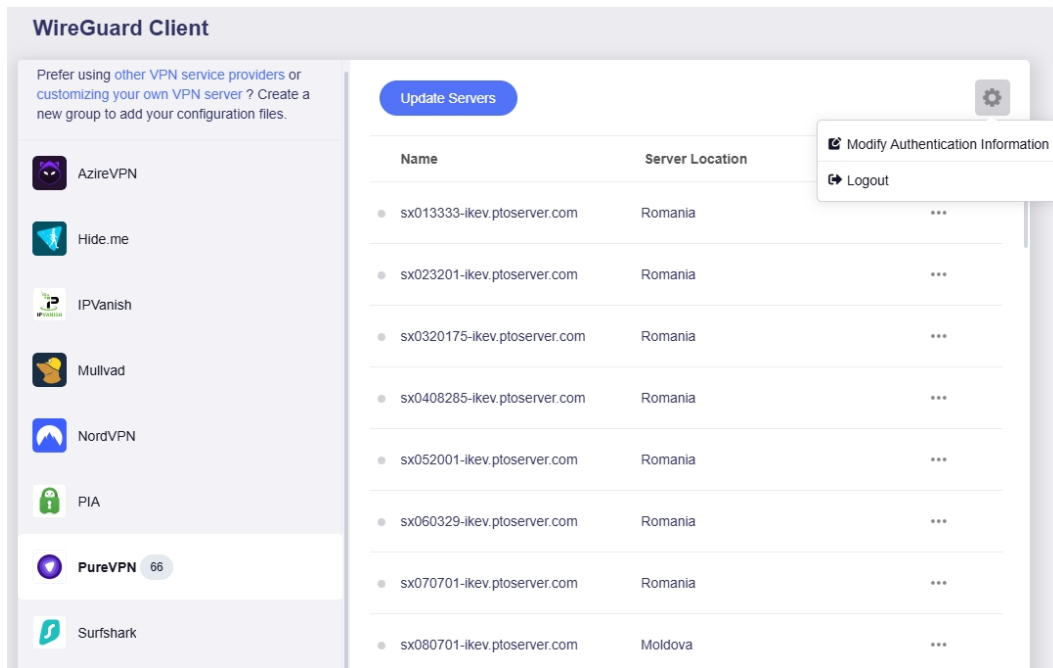

7. Delete all files.

You can click **Delete All** to delete all configuration files with one click, and choose whether to delete the private and public keys simultaneously.

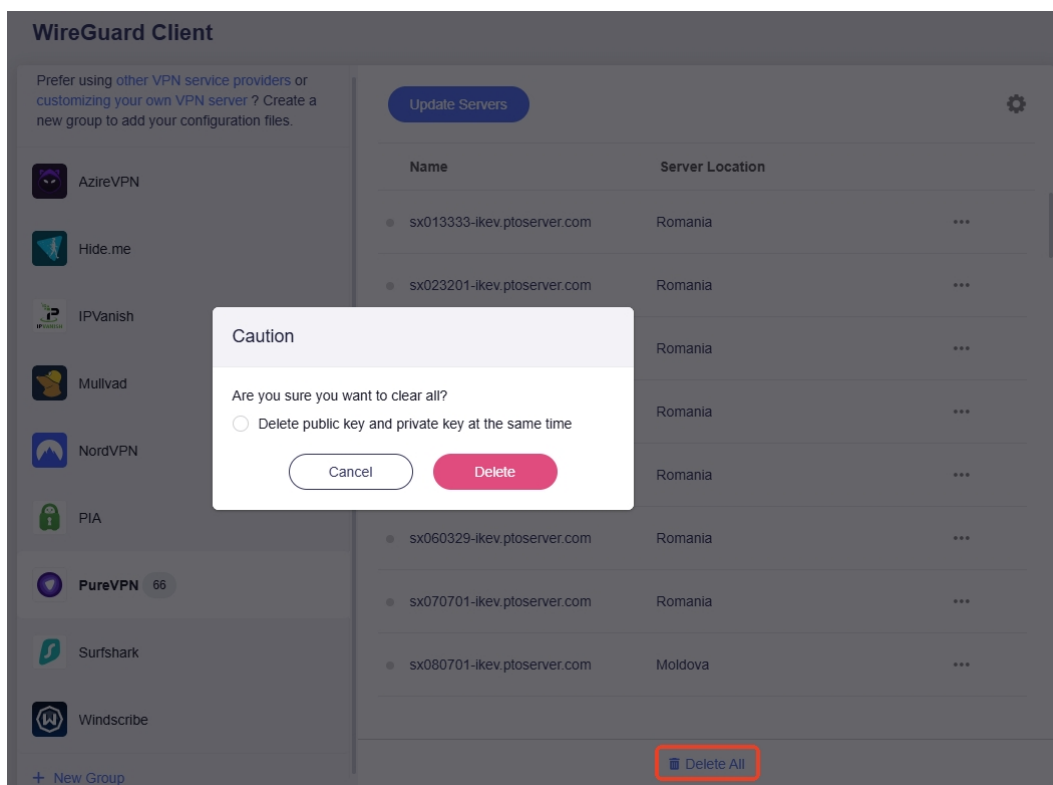

11.2.9 Set Up Surfshark

Follow the steps below to set your router as a Surfshark client.

1. Log in to your router's web admin panel and go to **VPN > WireGuard Client > Surfshark**.
2. Input Username and Password, then click **Save and Continue**.

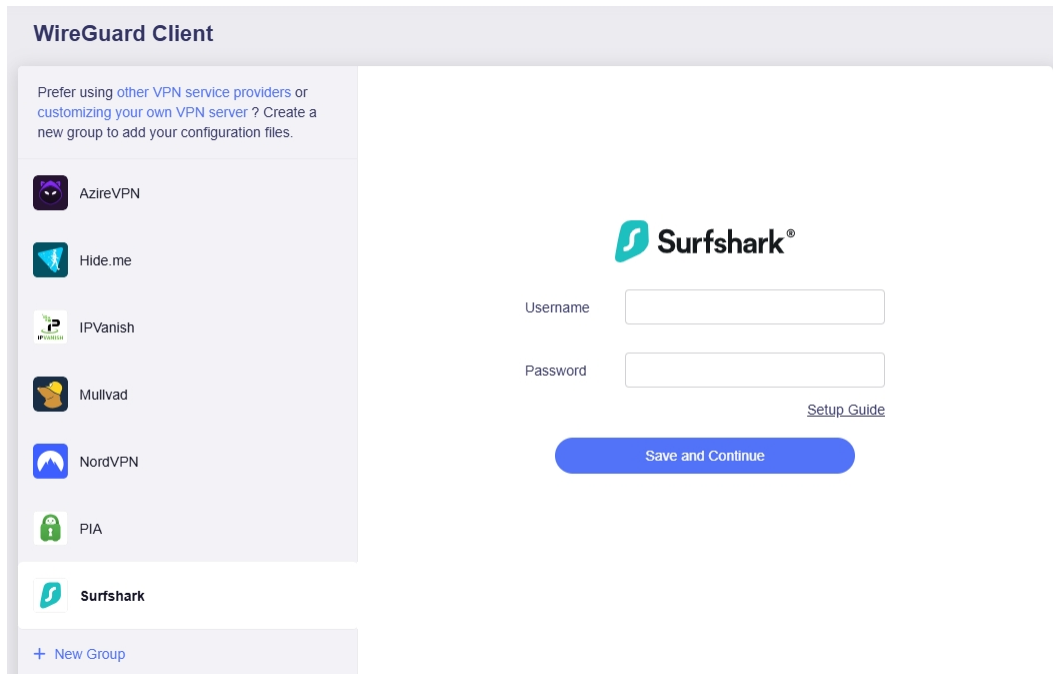

3. Select the server(s) you want to connect to, and click **Apply**.

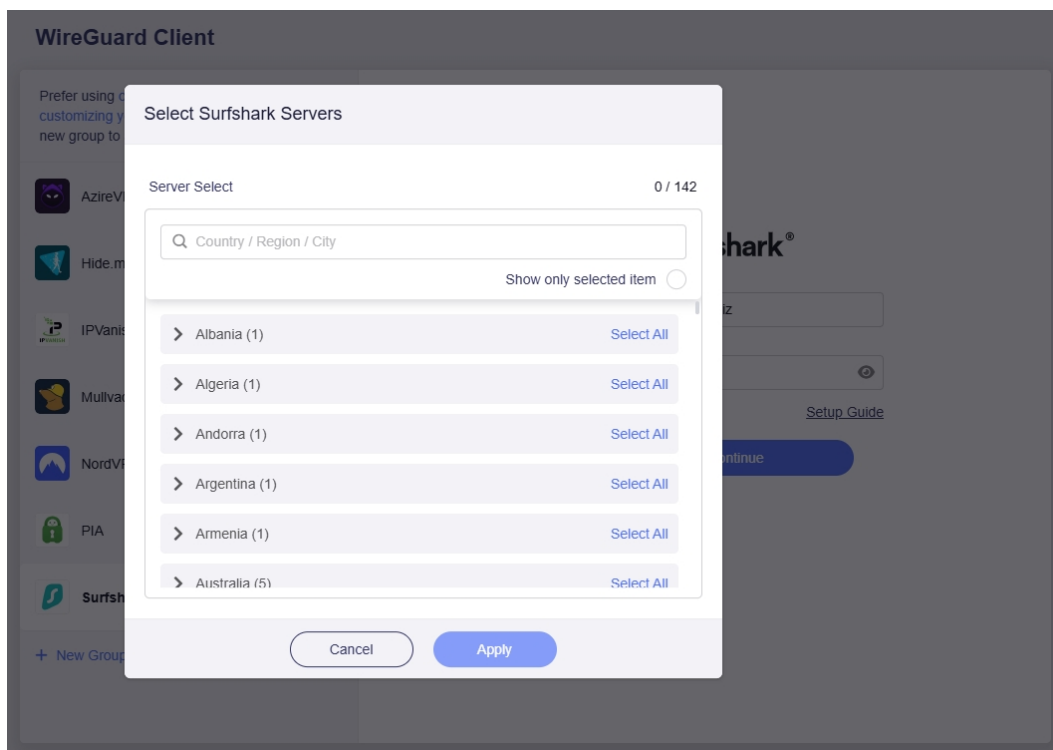

4. Select a preferred server, and click the three-dot icon on the right to start a connection.

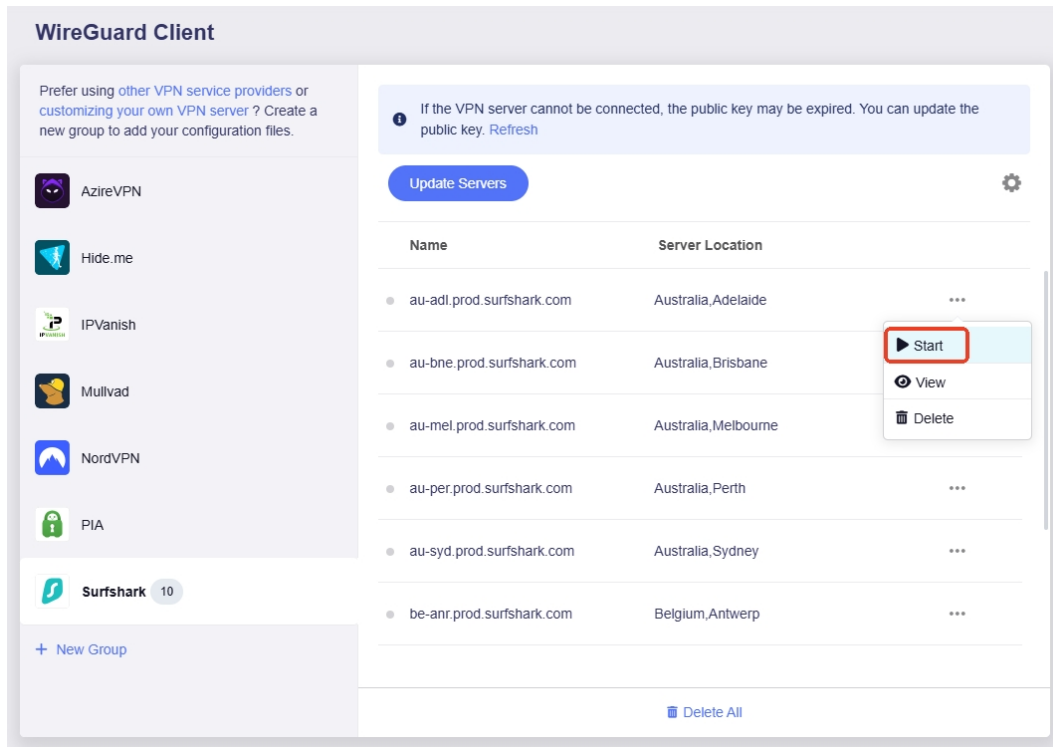

5. Once connected, a green dot will appear next to the configuration file.

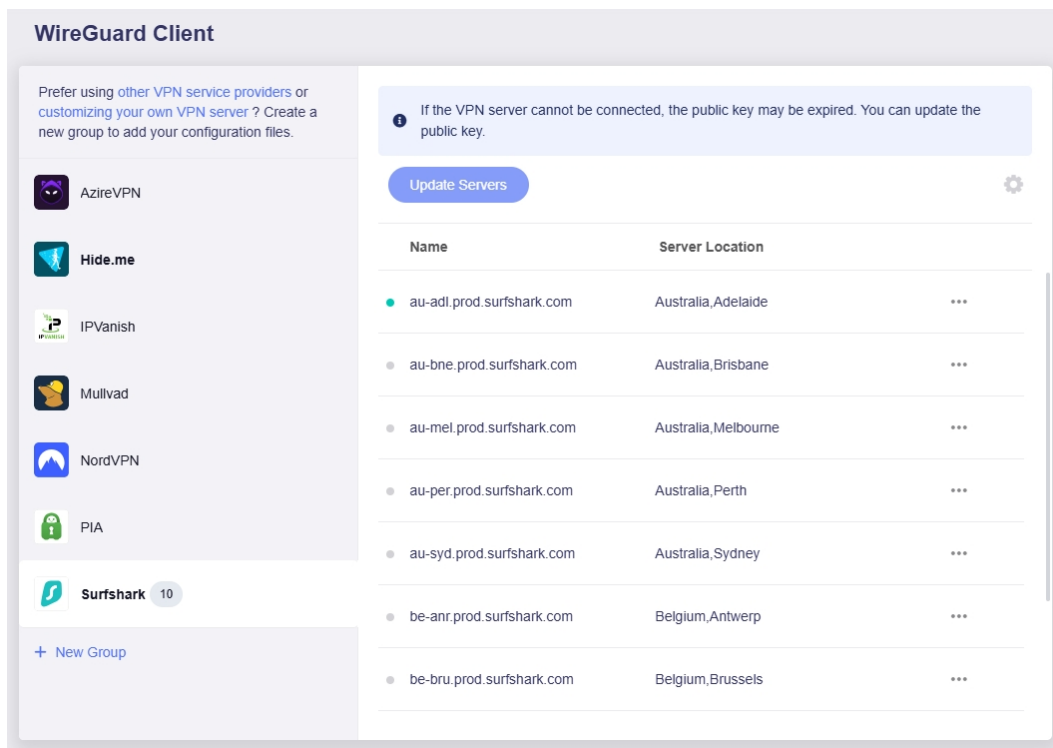

You can also check the VPN connection details on the **VPN Dashboard**.

6. Update servers.

You can click **Update Servers** to obtain the latest available server list, avoiding connection failures caused by server maintenance or shutdown.

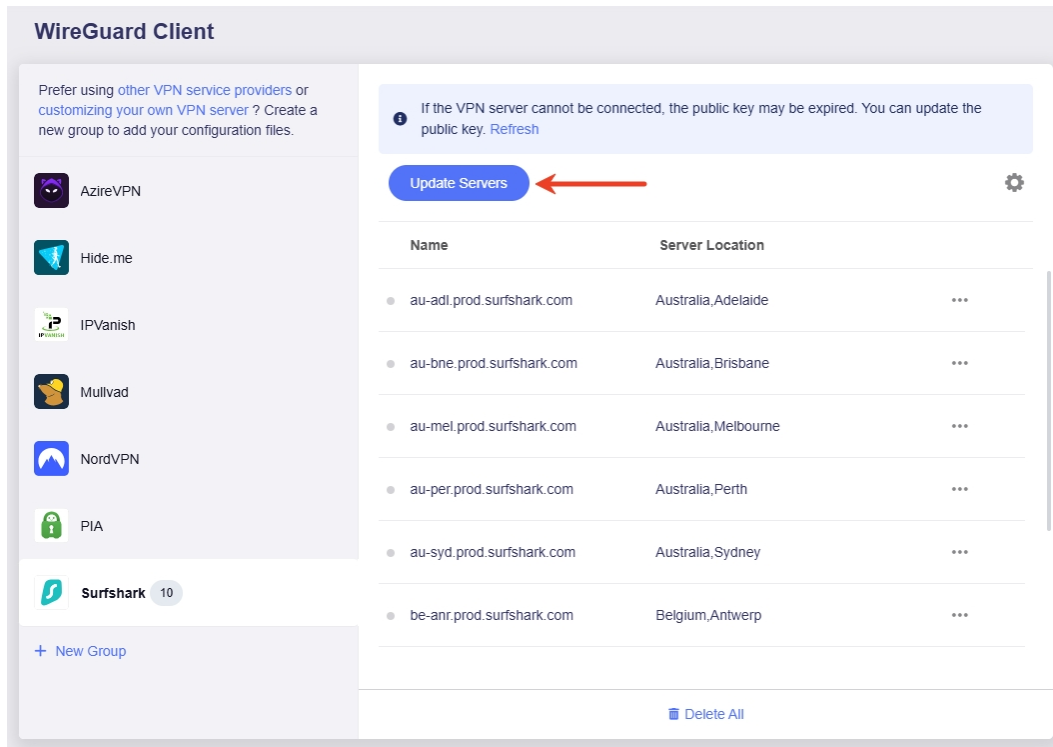

7. Edit credentials or logout.

Click the gear icon to edit your login credentials or log out.

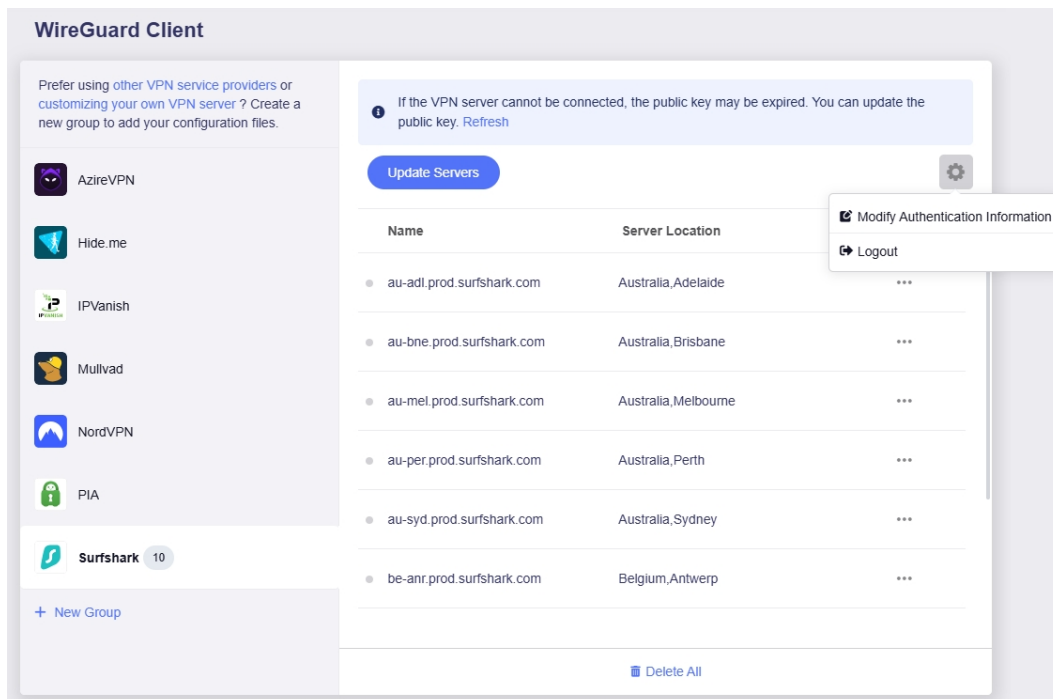

8. Refresh.

You can click **Refresh** to update the public key when the VPN server cannot be connected.

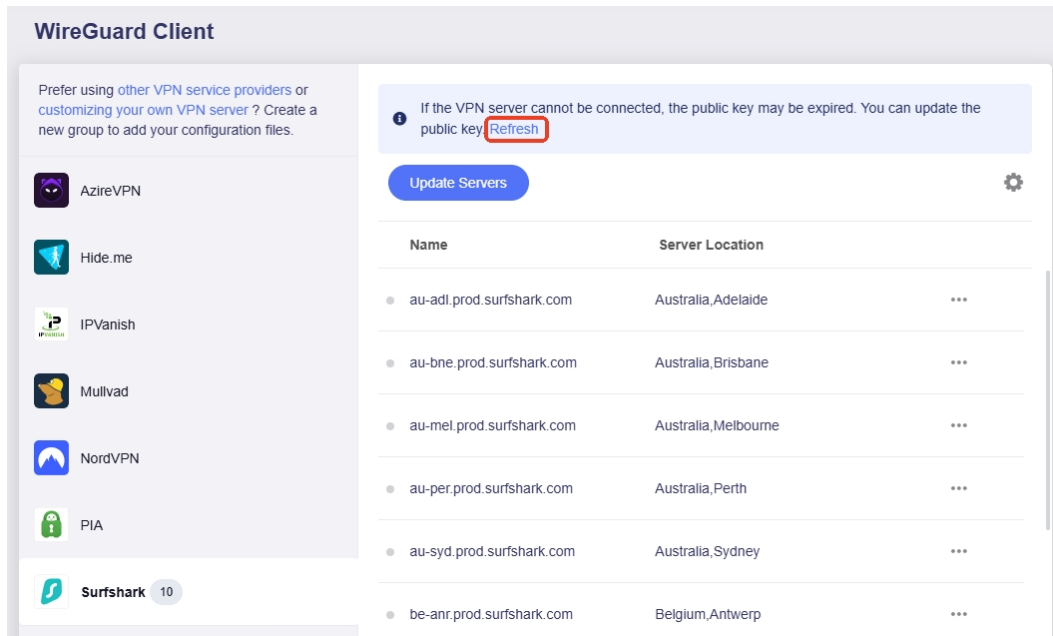

9. Delete all files.

You can click **Delete All** to delete all configuration files with one click, and choose whether to delete the private and public keys simultaneously.

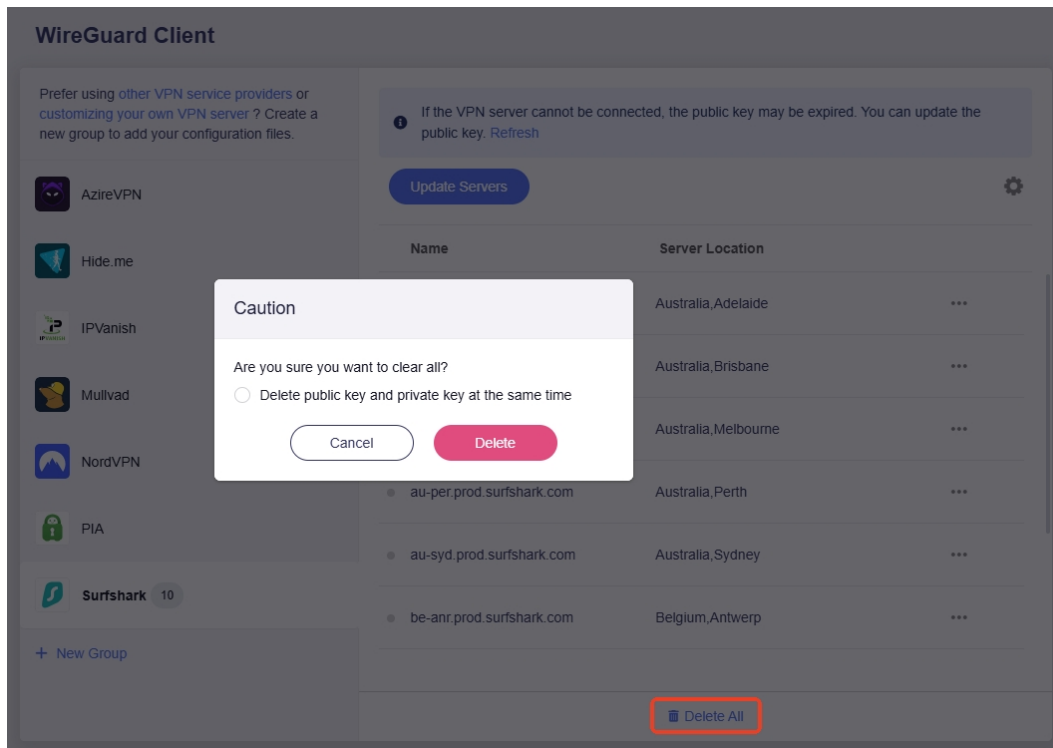

11.2.10 Set Up Windscribe

Follow the steps below to set your router as a Windscribe client.

1. Log in to the web admin panel and go to **VPN > WireGuard Client > Windscribe**.
2. Input Username and Password, then click **Save and Continue**. It will generate configuration files for each server.

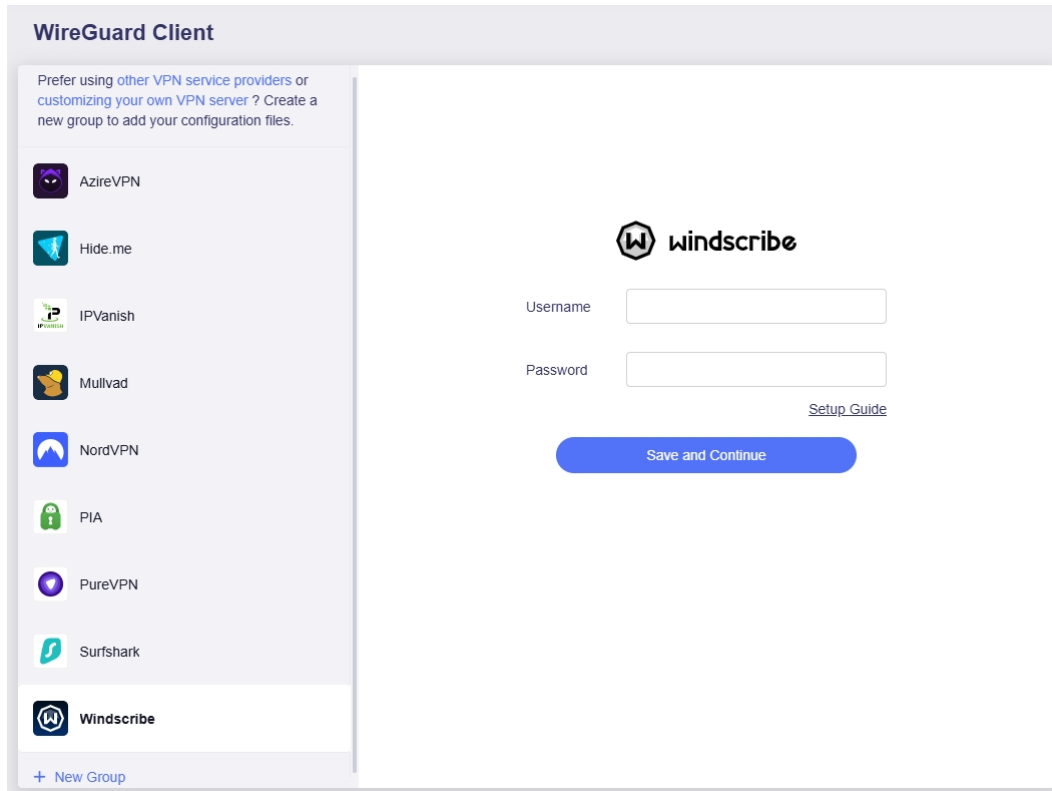

The screenshot shows the 'WireGuard Client' configuration interface. On the left, there is a list of VPN providers: AzireVPN, Hide.me, IPVanish, Mullvad, NordVPN, PIA, PureVPN, Surfshark, and Windscribe. The 'Windscribe' option is selected and highlighted. Below the list is a '+ New Group' link. The main content area displays the 'windscribe' logo, followed by 'Username' and 'Password' input fields. A 'Setup Guide' link is located below the password field. At the bottom of the main area is a blue 'Save and Continue' button.

3. Select the server(s) you want to connect to, and click **Apply**.

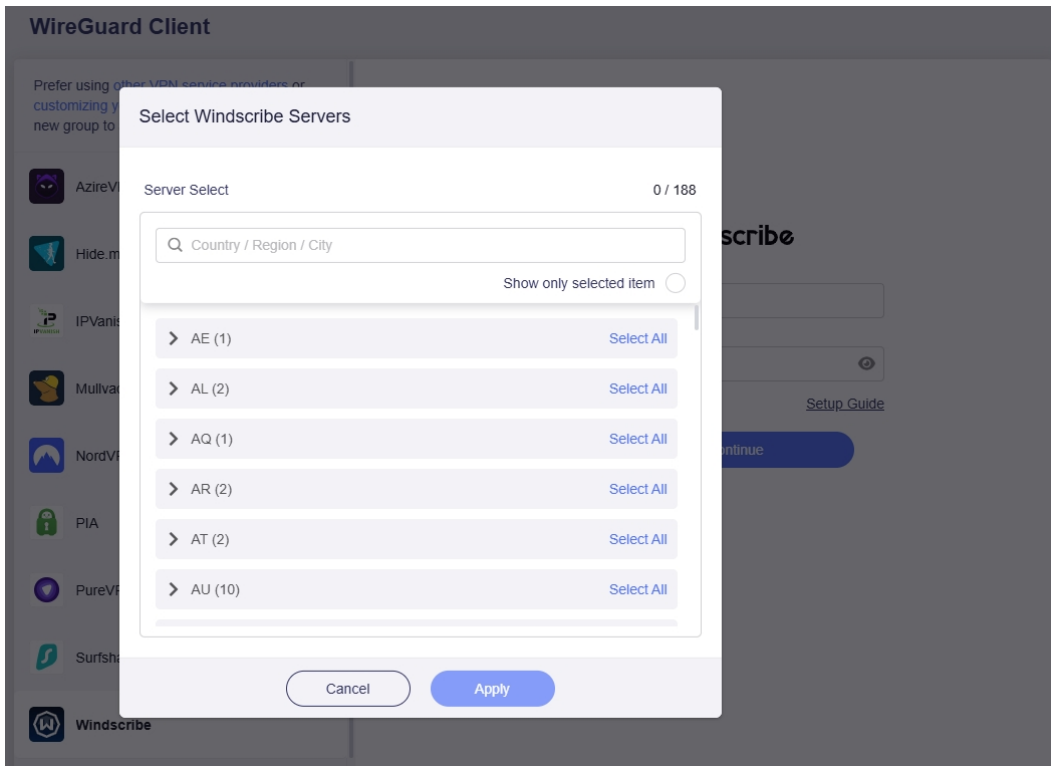

4. Select a preferred server, and click the three-dot icon on the right to start a connection.

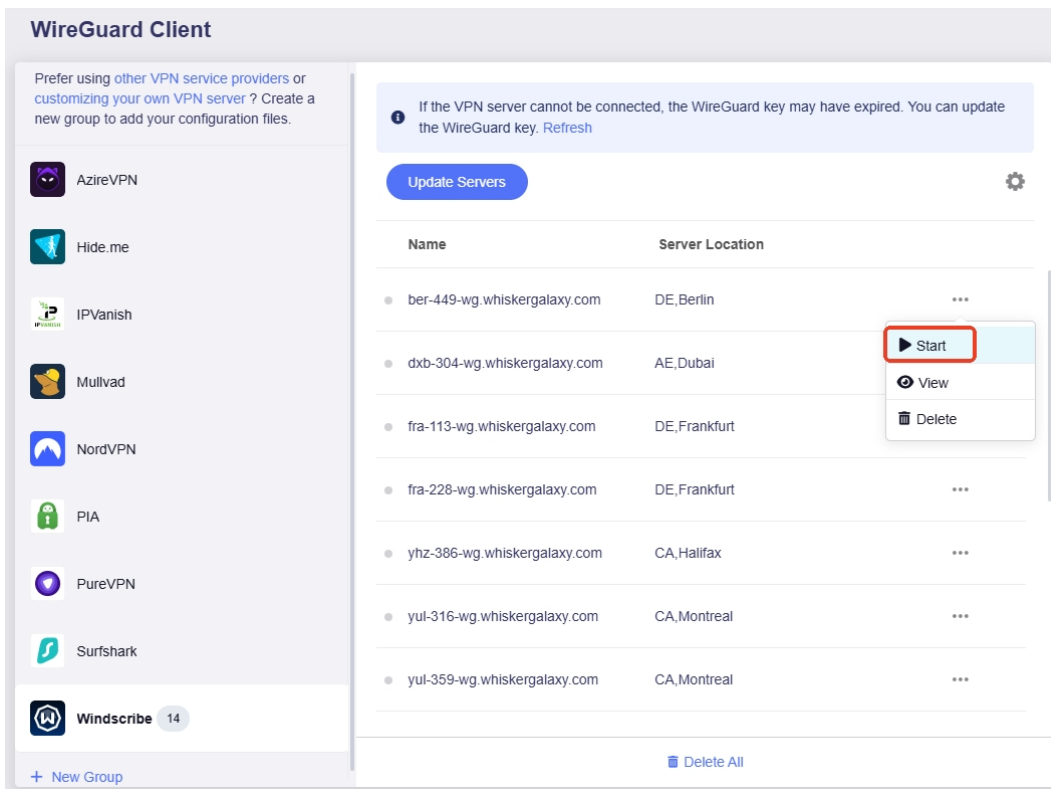

5. Once connected, a green dot will appear next to the configuration file.

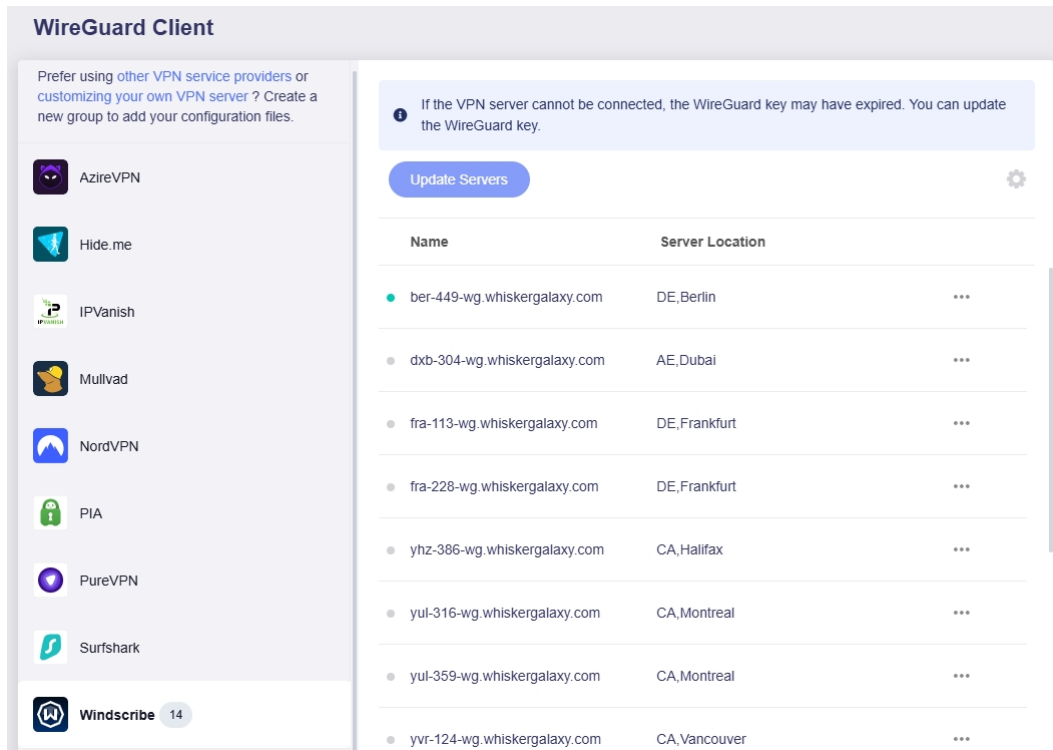

You can also check the VPN connection details on the **VPN Dashboard**.

6. Update servers.

You can click **Update Servers** to obtain the latest available server list, avoiding connection failures caused by server maintenance or shutdown.

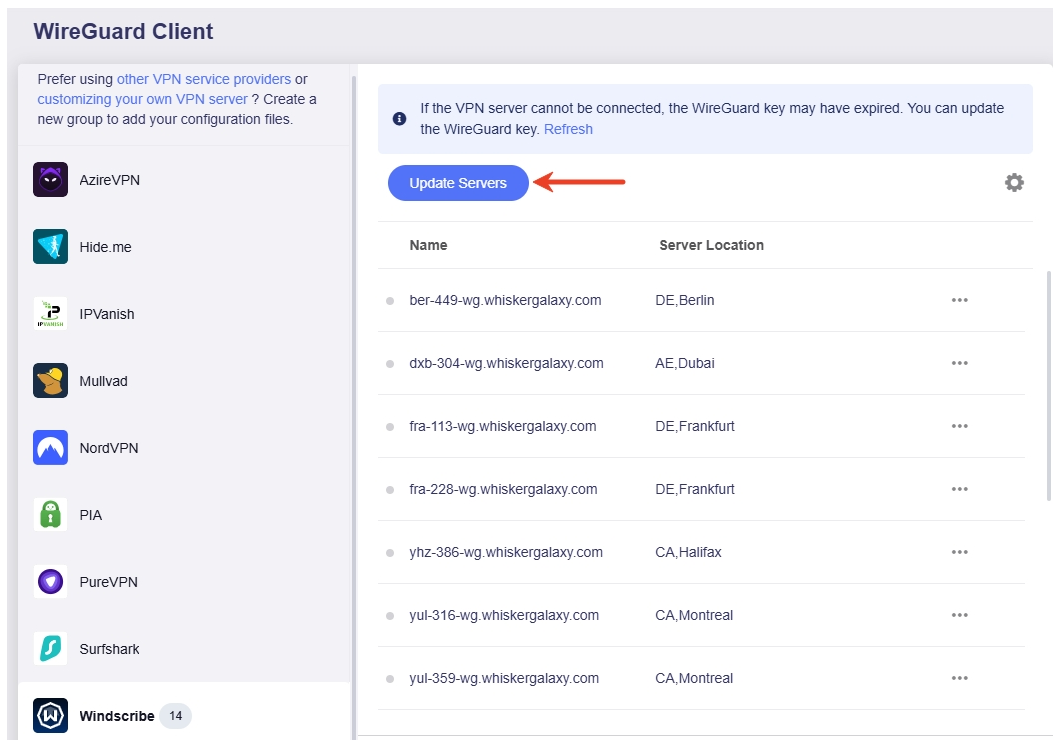

7. Edit credentials or logout.

Click the gear icon to edit your login credentials or log out.

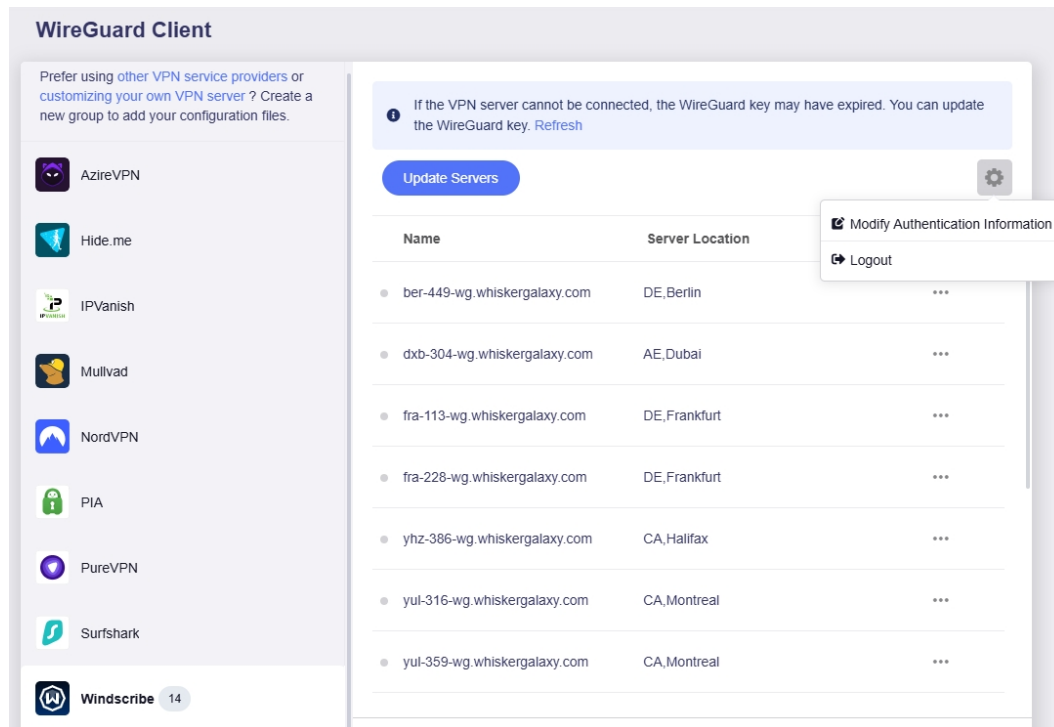

The screenshot shows the WireGuard Client interface. On the left, there is a sidebar with various VPN providers: AzireVPN, Hide.me, IPVanish, Mullvad, NordVPN, PIA, PureVPN, Surfshark, and Windscribe (with a '14' badge). The main area features a notification: "If the VPN server cannot be connected, the WireGuard key may have expired. You can update the WireGuard key. Refresh". Below this is an "Update Servers" button and a gear icon. A dropdown menu is open over the gear icon, containing "Modify Authentication Information" and "Logout". A table lists servers with columns for "Name" and "Server Location".

Name	Server Location
ber-449-wg.whiskergalaxy.com	DE, Berlin
dxh-304-wg.whiskergalaxy.com	AE, Dubai
fra-113-wg.whiskergalaxy.com	DE, Frankfurt
fra-228-wg.whiskergalaxy.com	DE, Frankfurt
yh3-386-wg.whiskergalaxy.com	CA, Halifax
yul-316-wg.whiskergalaxy.com	CA, Montreal
yul-359-wg.whiskergalaxy.com	CA, Montreal

8. Refresh.

You can click **Refresh** to update the public key when the VPN cannot be connected.

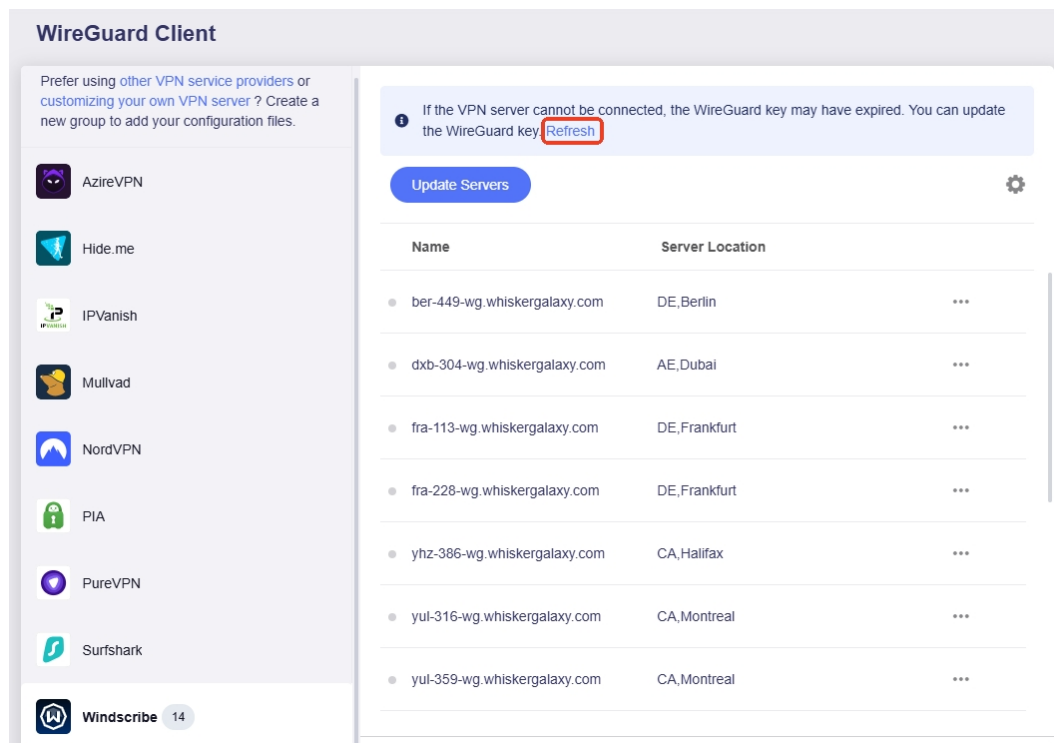

This screenshot is identical to the previous one, but the "Refresh" link in the notification message is highlighted with a red box. The rest of the interface, including the sidebar, notification, "Update Servers" button, gear icon, dropdown menu, and server table, remains the same.

9. Delete all files.

You can click **Delete All** to delete all configuration files with one click, and choose whether to delete the private and public keys simultaneously.

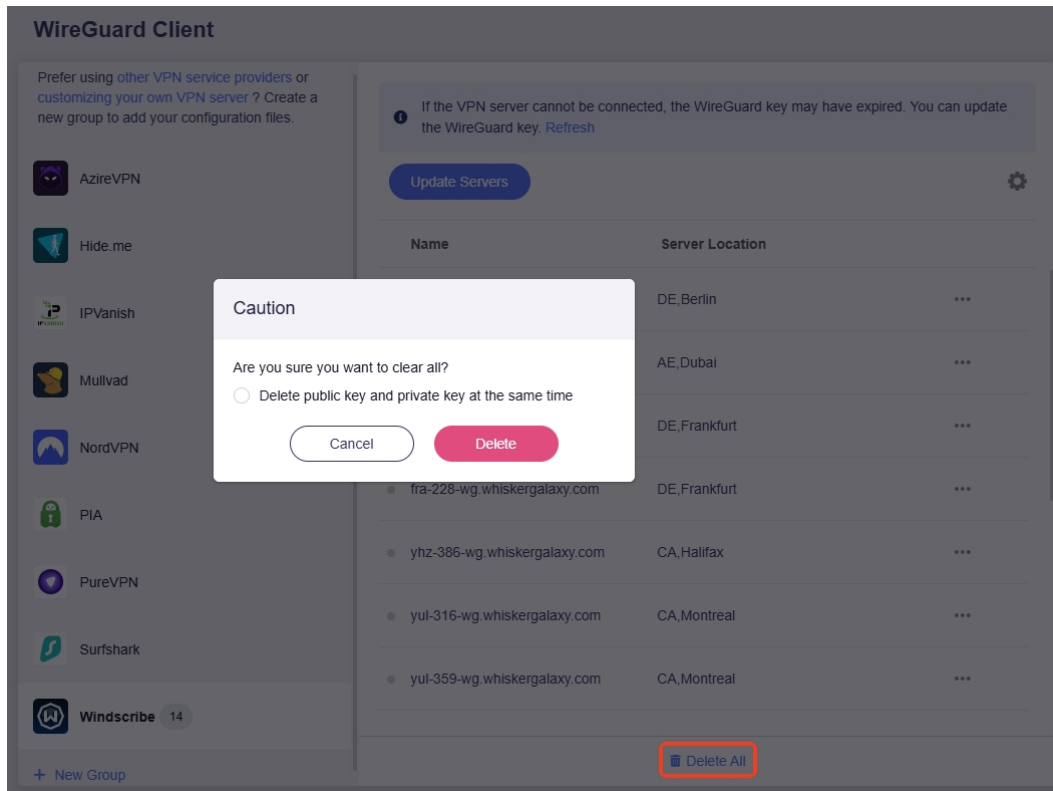

11.2.11 Set Up WireGuard Client Manually (for other providers)

If your WireGuard service provider is not integrated into the web admin panel, visit the official website of your subscribed service provider first to obtain the configuration file. Then upload it to the router to set up a WireGuard client. If you don't know how to download the configuration files, see [this guide](#) or contact their support.

Below are steps to upload the configuration file to the router to set up a WireGuard client.

1. Log in to your router's web admin panel and navigate to **VPN > WireGuard Client > Add Manually**.

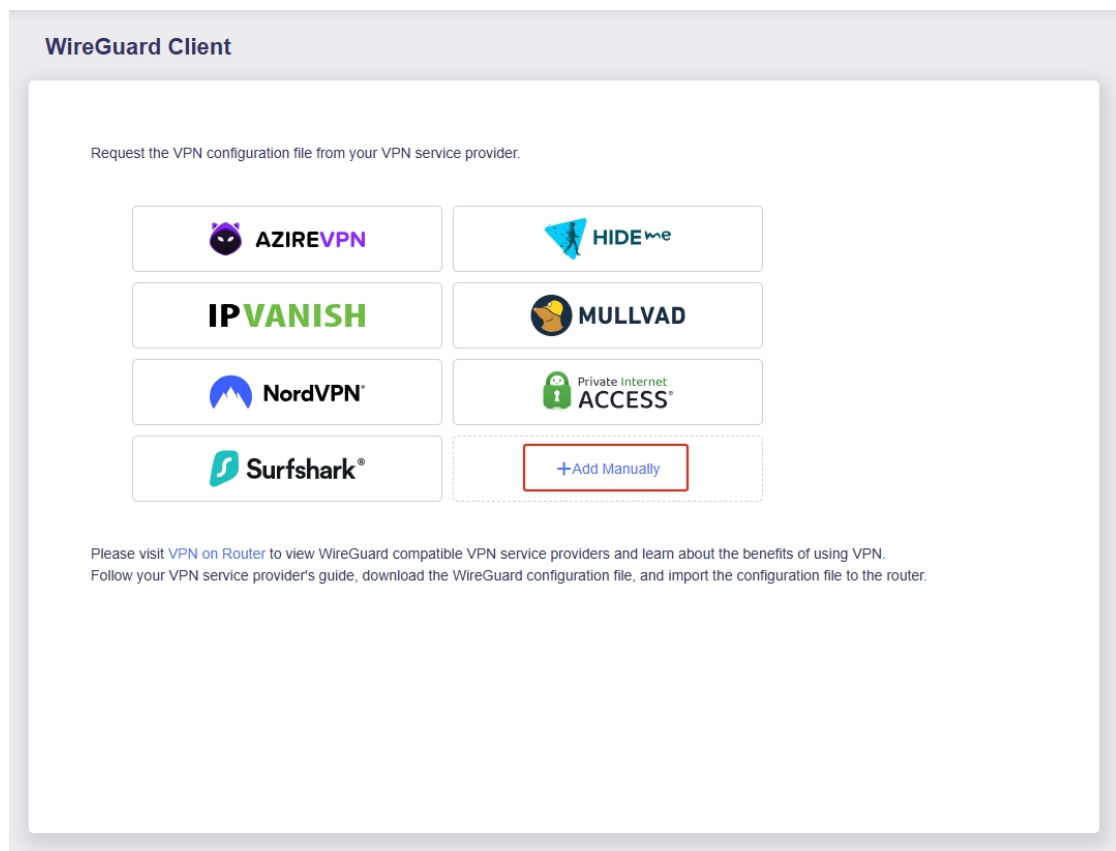

2. It will create a group on the left sidebar. Set a descriptive name for the group.

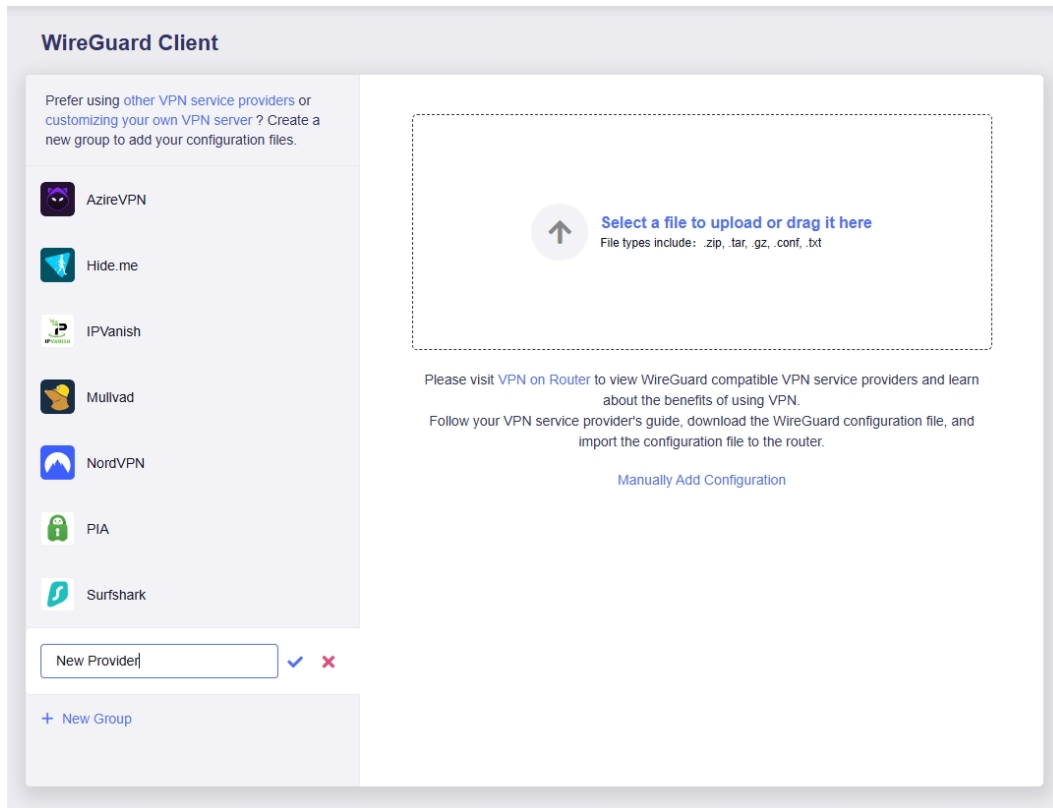

3. Click the upload area to upload your WireGuard configuration file (supported formats: zip, tar, gz, conf, txt), and click **Apply**.

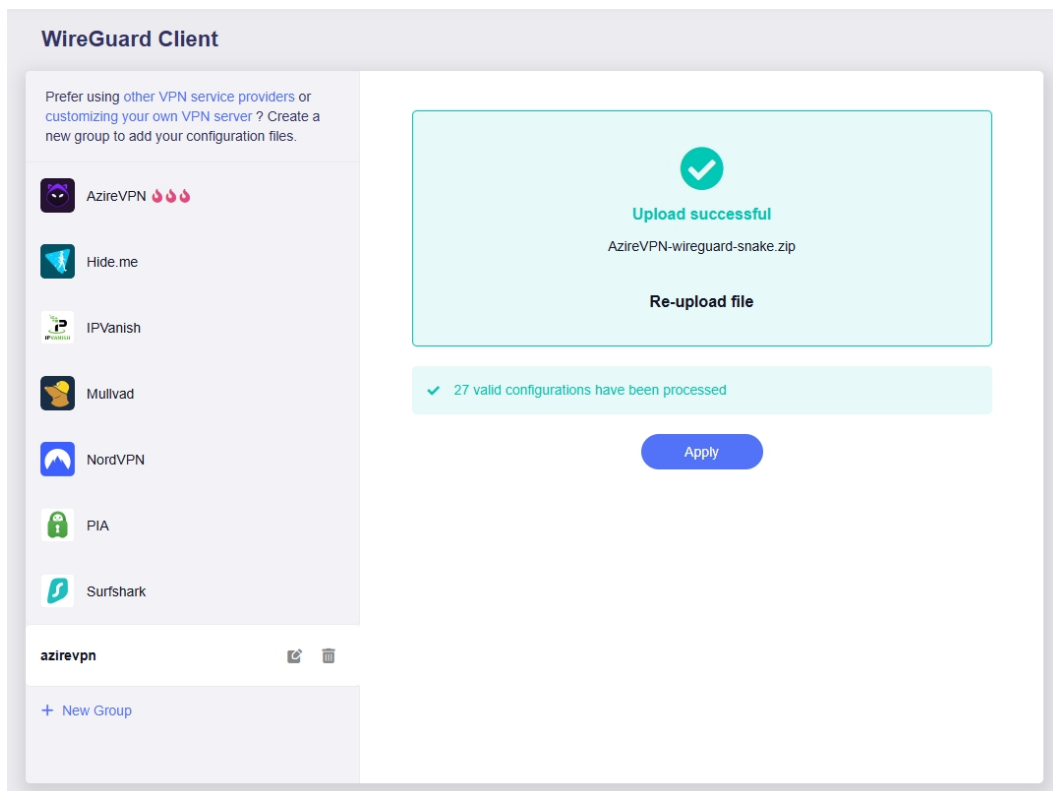

If you upload a compressed file containing multiple configuration files, it will be decompressed automatically, as shown below.

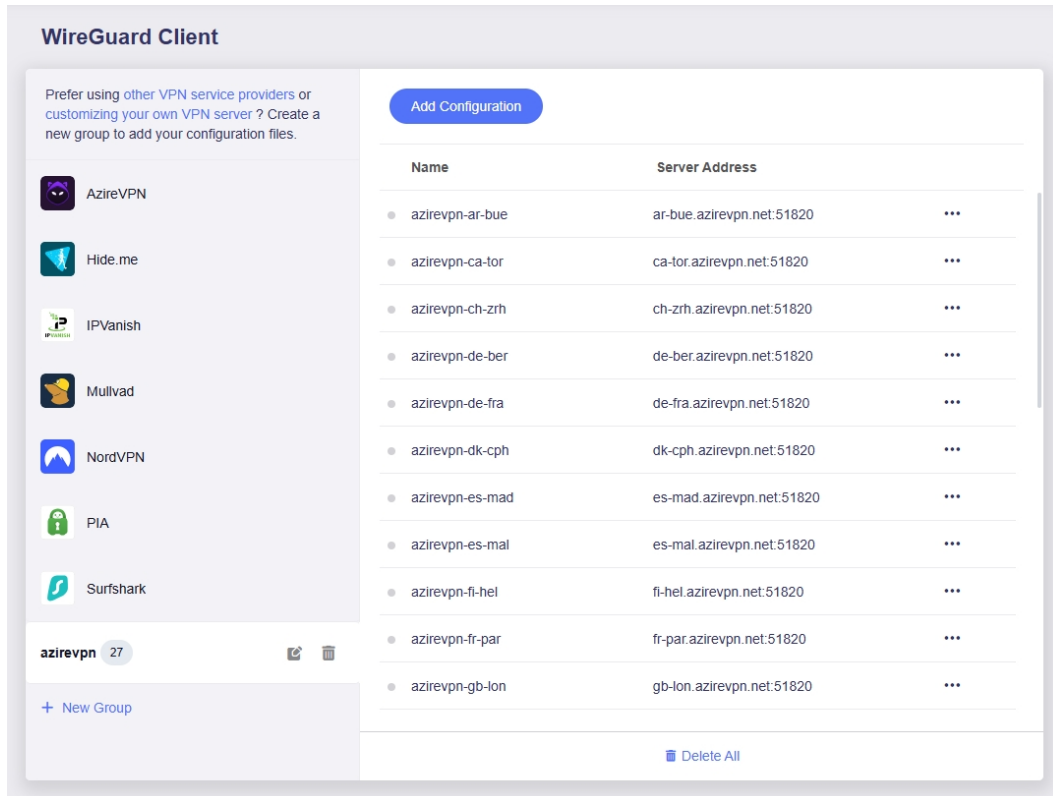

Alternatively, you can click **Manually Add Configuration** at the bottom of the upload area, add configuration details in text form and click **Apply**.

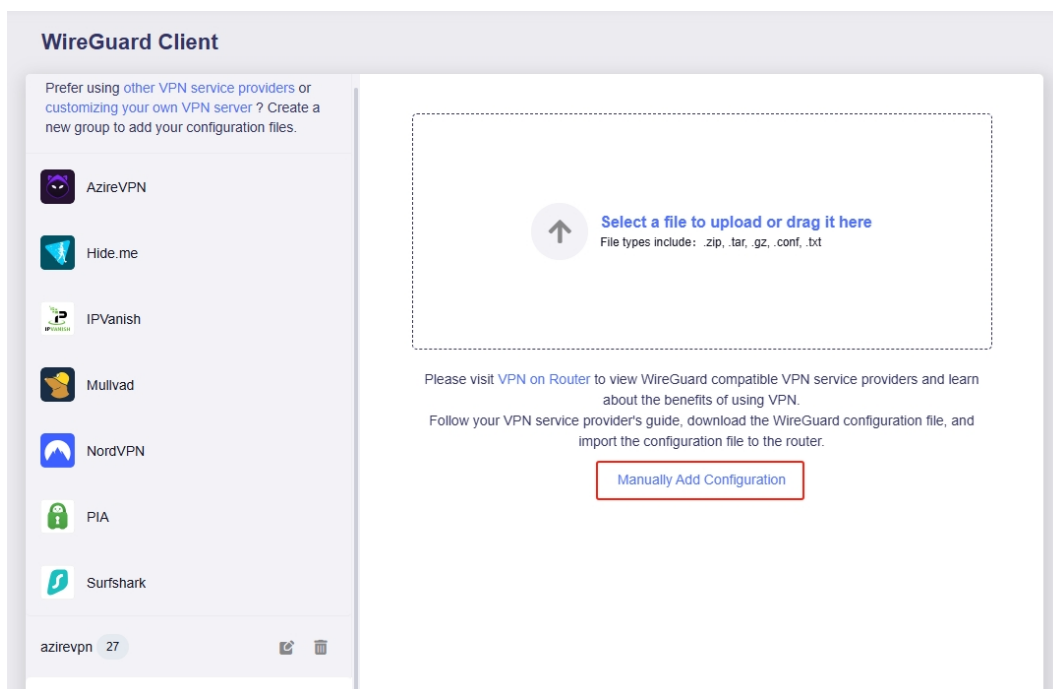

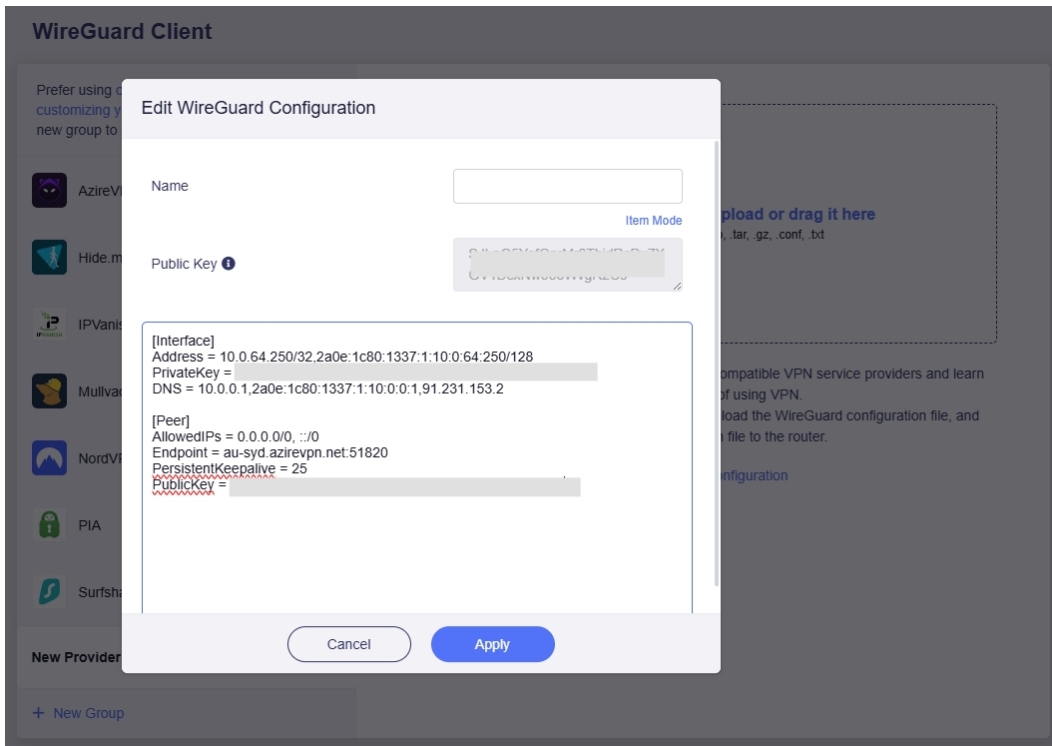

If you want to verify each item, you can switch to the Item mode and check the configuration details, then click **Apply**.

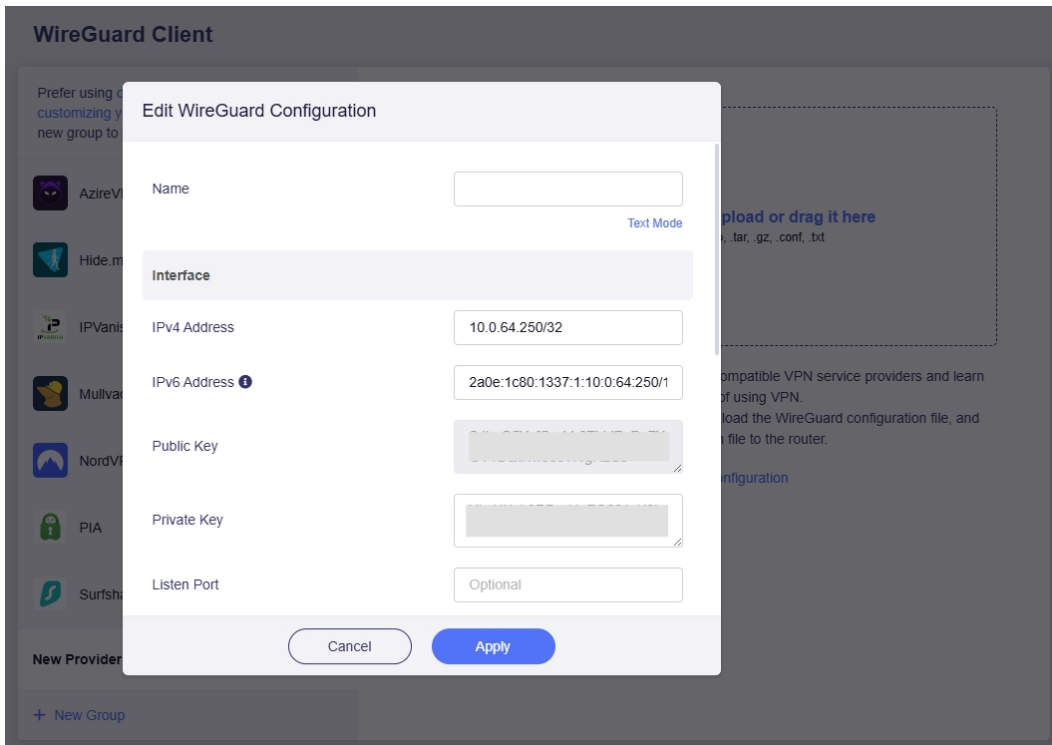

4. Click the three-dot icon on the right side to start the connection.

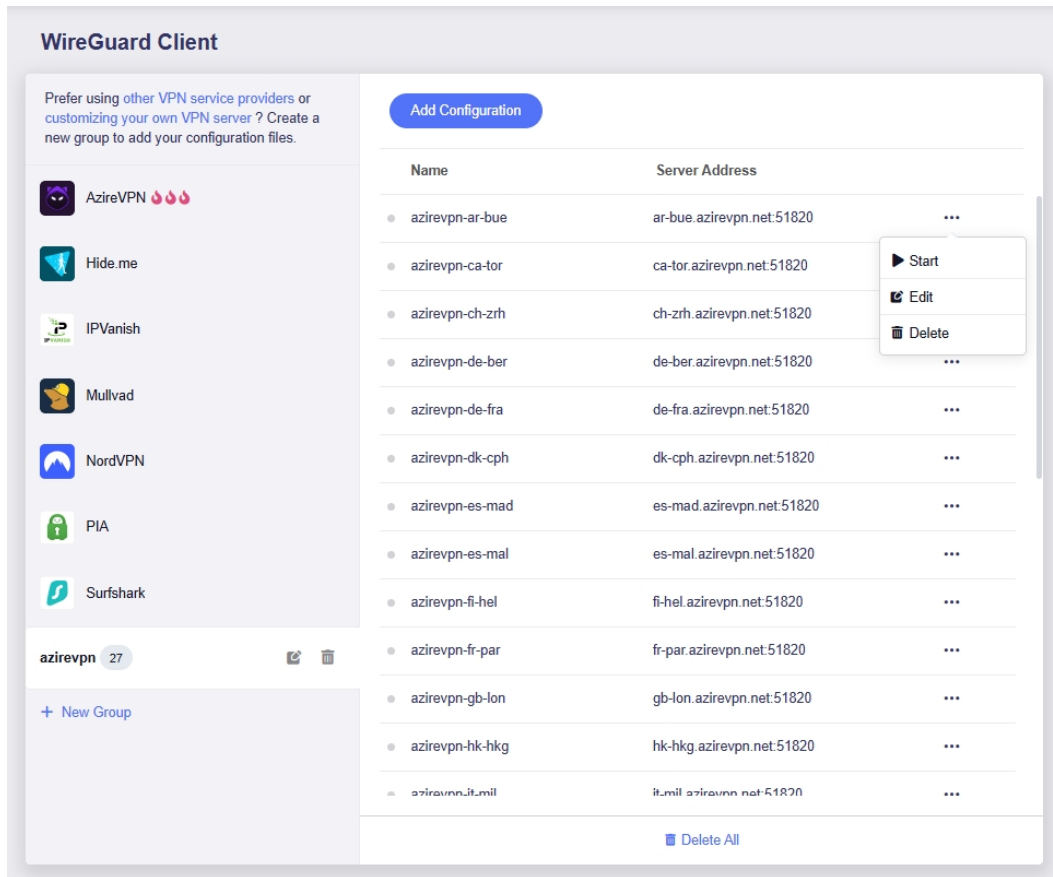

- Once connected, a green dot will appear next to the configuration file. You can check the VPN connection details on the **VPN Dashboard**.

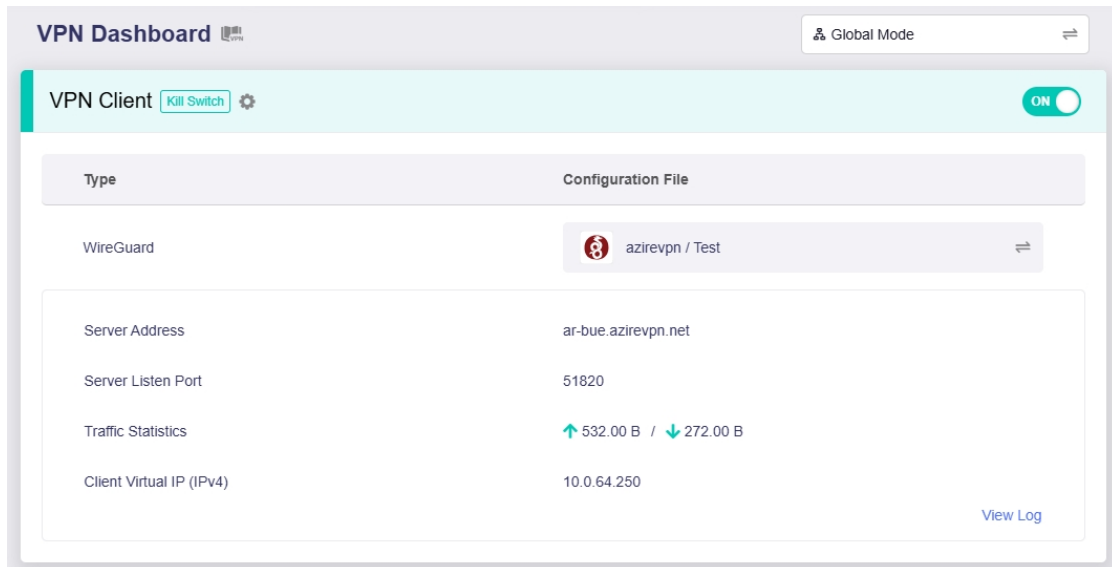

Chapter 12

Tor

This chapter provides a brief introduction to Tor (The Onion Router), a free and open-source software for enabling anonymous communication.

Tor (derived from **The Onion Router**) is a free and open-source software for enabling anonymous communication. It helps users to explore the internet with privacy. Note that this feature is currently in beta, and may have some bugs. When Tor is enabled, the following features will not work properly: VPN, DNS, IPv6, and AdGuard Home.

Follow the steps below to set up Tor as needed.

1. Log in to your router's web admin panel and navigate to **VPN > Tor**. Toggle the switch to enable it, enable Custom Exit Nodes as needed, and click **Apply**.

Tor Beta

i Tor (derived from "The Onion Router") is free, open-source software for enabling anonymous communication. It helps users to explore the internet with privacy. [Learn More >](#)
When Tor is enabled, the following features will not work properly: VPN, DNS, IPv6 and AdGuard Home.

Enable

Custom Exit Node

Apply

2. It will start connecting. If your network meets the requirements, it will show connected.

Tor Beta

i Tor (derived from "The Onion Router") is free, open-source software for enabling anonymous communication. It helps users to explore the internet with privacy. [Learn More >](#)
When Tor is enabled, the following features will not work properly: VPN, DNS, IPv6 and AdGuard Home.

Enable

Custom Exit Nodes

Tor Log Connected
tor connection succeeded

Chapter 13

Applications

This chapter introduces some applications in GL.iNet routers, e.g., Plug-ins, Dynamic DNS, Network Storage, AdGuard Home, ZeroTier, and Tailscale.

13.1 Plug-ins

The Plug-ins page allows you to manage OpenWrt packages.

Log in to your router's web admin panel, navigate to **APPLICATIONS > Plug-ins**. You can install or remove any package available in the repository. Click the **Refresh** button to update the package list before installing plug-ins.

Plug-ins

Manage Sources

Refresh

A B C D E F G H I J K L M N O P Q R S T U V W X Y Z

Name	Version	Size	Action
464xlat	12	5.05 KB	install
6in4	26	2.47 KB	install
6rd	10	3.79 KB	install
6to4	13	1.82 KB	install
ControlAppC	1.0	30.71 KB	install
UDPSpeeder	20210116.0-2	76.72 KB	install
acl	2.2.53-1	20.39 KB	install
acme	3.0.6-1	54.02 KB	install

Free space: 84.54 % (6.76 GB) Last Refresh Time: Thu, Jan 15, 2026 4:02 PM (UTC+08:00)

< 1 2 3 4 ... 1101 > Go

Note:

1. It is not recommended to update pre-installed plug-ins in GL.iNet official firmware, such as nginx, adguard home, tailscale, etc.
2. Third-party plugins manually installed by users can be updated; however, GL.iNet is not liable for any security issues from third-party plugins. For inquiries, please contact the respective third-party plugin authors.

13.2 Dynamic DNS

Dynamic Domain Name Service (DDNS, or Dynamic DNS) is a service used to map a domain name to the dynamic IP address of a network device. With Dynamic DNS, you can access your router remotely. A public IP address is required for this functionality.

13.2.1 Enable DDNS

1. Log in to your router's web admin panel, navigate to **APPLICATIONS > Dynamic DNS**, the page is displayed as below.

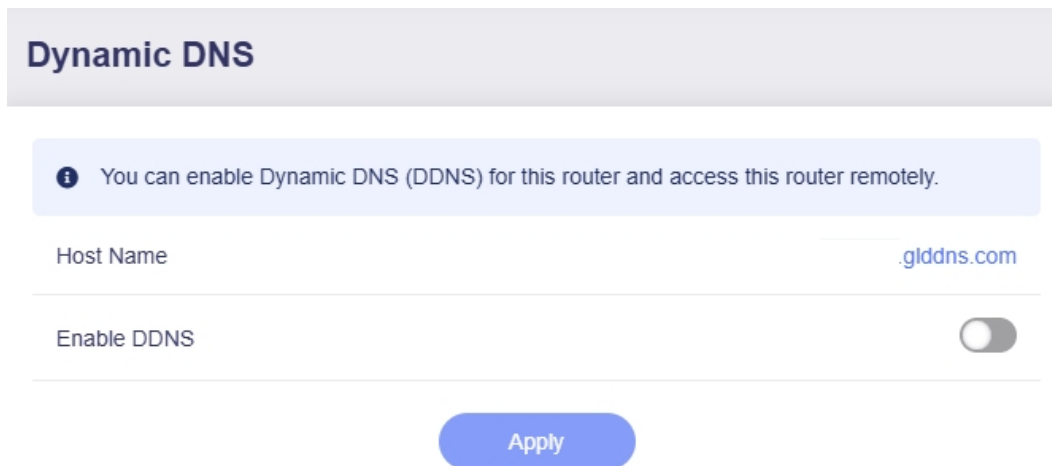

The screenshot shows the 'Dynamic DNS' configuration page. At the top, there is a header 'Dynamic DNS'. Below it is an information box: 'You can enable Dynamic DNS (DDNS) for this router and access this router remotely.' The 'Host Name' field is set to '.glddns.com'. The 'Enable DDNS' toggle switch is currently turned off. At the bottom, there is a blue 'Apply' button.

2. Toggle on **Enable DDNS**, read and agree to the **Terms of Services & Privacy Policy**, then click **Apply**.

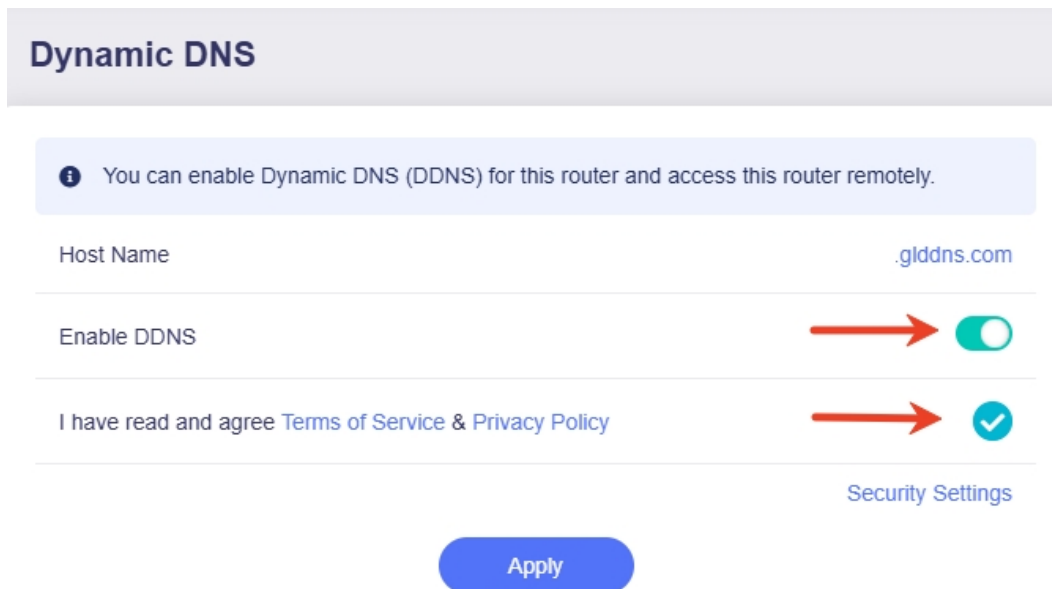

The screenshot shows the 'Dynamic DNS' configuration page after the first step. The 'Enable DDNS' toggle switch is now turned on, indicated by a red arrow pointing to it. Below the toggle, there is a checkbox labeled 'I have read and agree Terms of Service & Privacy Policy', which is also checked, indicated by a red arrow. At the bottom right, there is a link for 'Security Settings'. At the bottom center, there is a blue 'Apply' button.

3. Click **Security Settings** in the bottom right corner.

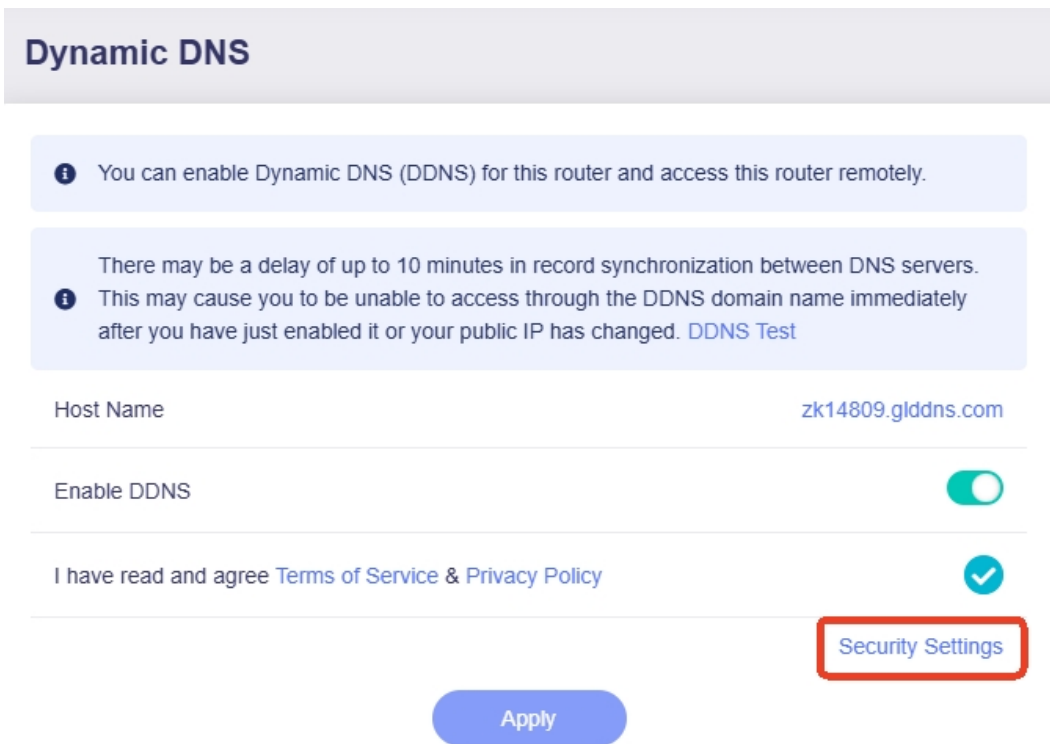

4. In the pop-up window, check if the remote access you want to use is enabled.

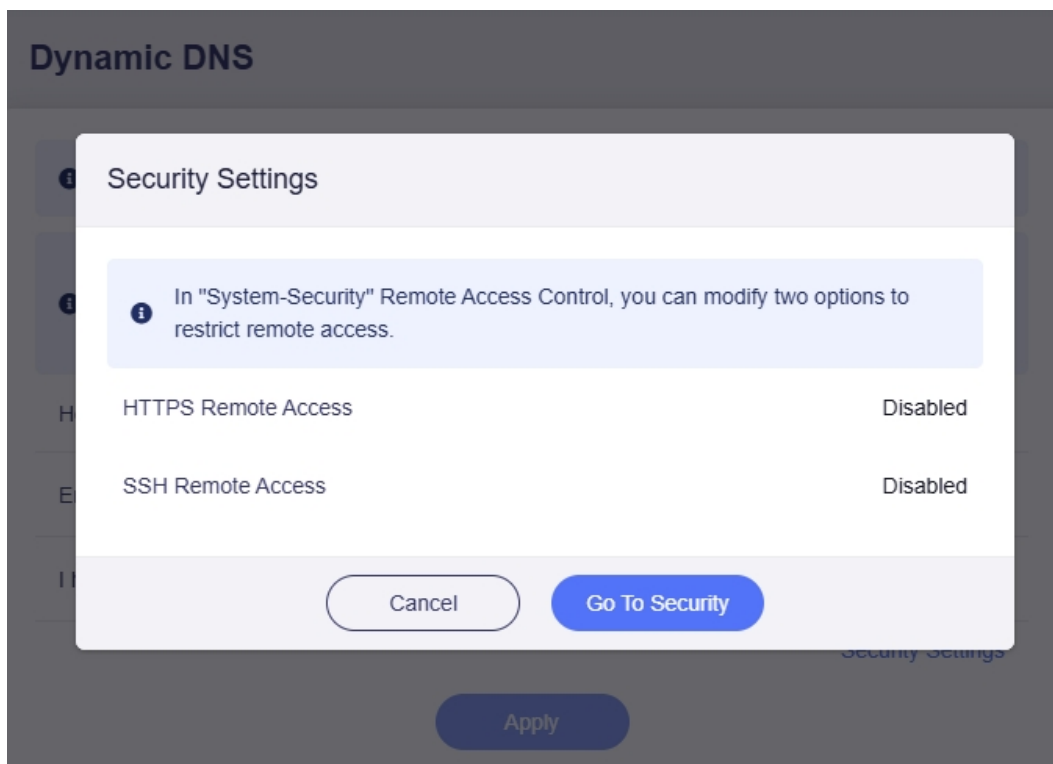

If not, go to **Security > Management Control > Remote Access Control** to enable it, and click **Apply**.

Remote Access Control

Allow Ping from WAN

HTTPS Remote Access

SSH Remote Access

Allow Remote Access only from Specific IPs ⓘ

Apply

Note:

1. There may be a delay of up to 10 minutes in record synchronization between DNS servers. This may prevent you from accessing through the DDNS domain name immediately after enabling it or when your public IP changes.
2. If you enable DDNS and VPN Client at the same time, ensure that [Services From GL.iNet Use VPN](#) is disabled.

13.2.2 Check if DDNS Works

You can check if DDNS works using the DDNS test tool or manually via commands.

Method 1. Use DDNS Test tool

1. In the Dynamic DNS page, click the **DDNS Test**.

Dynamic DNS

i You can enable Dynamic DNS (DDNS) for this router and access this router remotely.

There may be a delay of up to 10 minutes in record synchronization between DNS servers.

i This may cause you to be unable to access through the DDNS domain name immediately after you have just enabled it or your public IP has changed. [DDNS Test](#) 

Host Name .glddns.com

2. Make sure the IP address from DDNS domain resolution matches the router's WAN IP. If not, a yellow prompt will appear at the top, indicating that the router might be behind NAT, and you need to set up port forwarding on the upstream router.

DDNS Test ×

⚠ The IP address from DDNS domain resolution is not the same as the WAN IP of the device.
You need an Internet Public IP address to use Dynamic DNS.

i If this router is behind NAT, you may need to set up port forwarding on your ISP router.
i If you have VPN Client enabled, please disable "Services from GL.iNet Use VPN" in the global options.

IP address from DDNS Domain Resolution

IPv4	205.185.113.19
------	----------------

WAN Interface IP address

Ethernet	192.168.5.135
----------	---------------

Method 2. Use commands

1. Use **nslookup** command to obtain the mapping between domain name and IP address, as shown below.

```
[ubuntu@xxxxxxx ~]$ nslookup xxxxxxxx.glddns.com 8.8.8.8
Server:      8.8.8.8
Address:     8.8.8.8#53
```

- Replace “xxxxxxx.glddns.com” in the image above with your Host Name.
 - The “8.8.8.8” is the Google DNS. You can use it or replace it with other DNS, then press Enter.
2. If you get a public IP address as an output, such as “103.81.180.10” in the image below, it indicates that your DDNS domain has been successfully mapped to a public IP address.

```
[ubuntu@xxxxxxx ~]$ nslookup xxxxxxxx.glddns.com 8.8.8.8
Server:      8.8.8.8
Address:     8.8.8.8#53
```

```
Non-authoritative answer:
Name:   xxxxxxxx.glddns.com
Address: 103.81.180.10
```

3. On a device connected to the router, search for “what is my ip address” in a browser, or visit a website like [What Is My IP Address](#). You will get your public IP address. Compare the two IP addresses obtained from Step 1 and 2. If they are the same, the DDNS is in effect, otherwise it is not.
4. If you get a message “server can’t find xxxxxxx.glddns.com: NXDOMAIN”, as shown below, it indicates that domain resolution failed, and your DDNS domain has not been successfully mapped to a public IP address.

```
root@GL-MT5000:~#
root@GL-MT5000:~# nslookup *****.glddns.com 8.8.8.8
Server:      8.8.8.8
Address:     8.8.8.8#53

** server can't find *****.glddns.com: NXDOMAIN
** server can't find *****.glddns.com: NXDOMAIN
root@GL-MT5000:~#
```

13.2.3 HTTPS Remote Access

A **Public IP address** is required for HTTPS remote access. See [here](#) to verify whether your ISP assigns you a public IP address.

If your router is behind NAT, configure port forwarding (**port 443**) on the upstream router for HTTPS access.

Follow the steps below to enable HTTPS remote access for your router.

1. On the Dynamic DNS page, toggle on **Enable DDNS**, agree to the **Terms of Services & Privacy Policy**, then click **Apply**.

Dynamic DNS

i You can enable Dynamic DNS (DDNS) for this router and access this router remotely.

Host Name .glddns.com

Enable DDNS 

I have read and agree [Terms of Service & Privacy Policy](#) 

[Security Settings](#)

[Apply](#)

2. In the web admin panel, go to **SYSTEM > Security > Remote Access Control**.

Remote Access Control

Allow Ping from WAN

HTTPS Remote Access

SSH Remote Access

[Apply](#)

3. Enable **HTTPS Remote Access**, and click **Apply**.

Remote Access Control

Allow Ping from WAN	<input type="checkbox"/>
HTTPS Remote Access	<input checked="" type="checkbox"/>
SSH Remote Access	<input type="checkbox"/>
Allow Remote Access only from Specific IPs ⓘ	<input type="checkbox"/>

Apply

Once enabled, you can access the router's admin panel from anywhere using the DDNS host name over HTTPS, e.g., **https://xxxxxxx.glddns.com**. If port forwarding is configured, access it as **https://xxxxxxx.glddns.com:external_port** (replace the external_port with your actual port number).

Note: This function uses self-signed certificates; therefore, browsers will indicate "Your connection is not private" when accessing the router's admin panel via the DDNS host name over HTTPS, as shown below (port 8001 is used as an example).

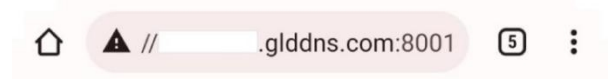

Your connection is not private

Attackers might be trying to steal your information from [redacted].glddns.com (for example, passwords, messages, or credit cards). [Learn more](#)

NET::ERR_CERT_AUTHORITY_INVALID

To proceed the HTTPS remote access, click **Advanced** at the bottom, then click **Proceed to xxxxxxx.glddns.com** to continue.

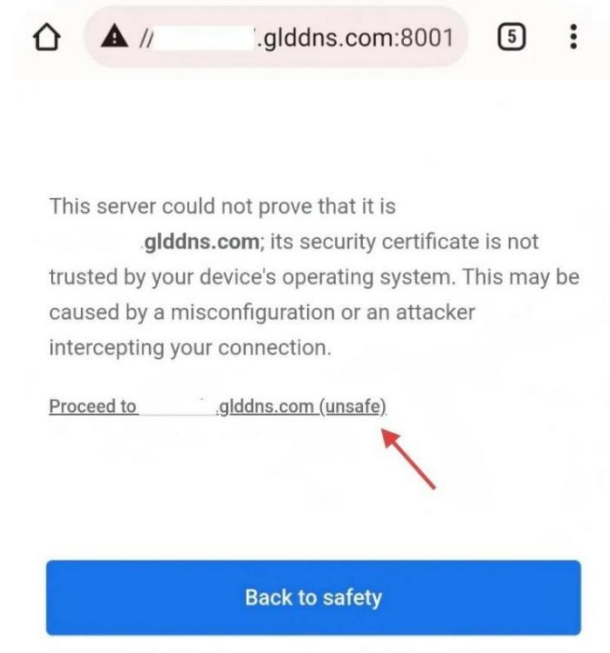

You will then be able to access the router's web admin panel using the DDNS host name over **HTTPS**.

13.2.4 SSH Remote Access

A **Public IP address** is required for SSH remote access. See [here](#) to verify whether your ISP assigns you a public IP address.



If your router is behind NAT, configure port forwarding (**port 22**) on the upstream router for SSH remote access.

Follow the steps below to enable SSH remote access for your router.

1. On the Dynamic DNS page, toggle on **Enable DDNS**, agree to the **Terms of Services & Privacy Policy**, then click **Apply**.

Dynamic DNS

i You can enable Dynamic DNS (DDNS) for this router and access this router remotely.



Host Name	.glddns.com
Enable DDNS	
I have read and agree Terms of Service & Privacy Policy	

[Security Settings](#)

Apply

2. In the web admin panel, go to **SYSTEM > Security > Remote Access Control**.

Remote Access Control

Allow Ping from WAN	
HTTPS Remote Access	
SSH Remote Access	

Apply

3. Enable **SSH Remote Access**, and click **Apply**.

Remote Access Control

Allow Ping from WAN	<input type="checkbox"/>
HTTPS Remote Access	<input type="checkbox"/>
SSH Remote Access	<input checked="" type="checkbox"/>
Allow Remote Access only from Specific IPs ⓘ	<input type="checkbox"/>

[Apply](#)

Once enabled, you can access the router's admin panel from anywhere using the DDNS host name over SSH, e.g., **ssh root@xxxxxxx.glddns.com**. If port forwarding is configured, access it as **ssh root@xxxxxxx.glddns.com:external_port** (replace the external_port with your actual port number).

13.3 Network Storage

Network storage enables wireless file sharing across devices by connecting a USB drive or SD card to your router. The router converts the storage device into a shared network drive, accessible to all Wi-Fi-connected devices.

Among GL.iNet models, some support MicroSD (TF) cards, while others feature a USB port, compatible with USB flash drives and portable external hard drives. You can configure Samba, WebDAV, or DLNA for these storage devices, which support common formats such as NTFS, FAT32, and EXT4.

Note:

1. The power consumption of USB hard drive is quite high. Use it with an external power supply, otherwise it may cause malfunction.
2. Some models have USB Port or MicroSD slot but have limited storage space and do not support network storage.

13.3.1 Connect Storage

1. Connect your storage device to the router.
 - For a TF card: Power off the router, insert the TF card, then power it on.
 - For a USB drive: Plug it directly into the USB port.
 - For an external hard drive: Connect it to a separate power supply (if required), then plug it into the router.
2. Log in to your router's web admin panel, navigate to **APPLICATIONS > Network Storage**. You can enable file transfer services, and manage the shared folder here.
3. If the storage device is detected, the **Disk Management** will be displayed as follows.

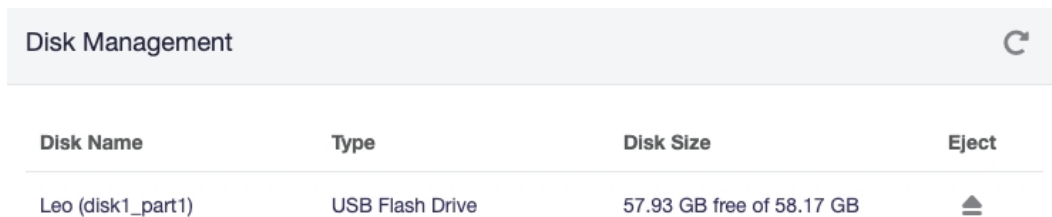

Disk Name	Type	Disk Size	Eject
Leo (disk1_part1)	USB Flash Drive	57.93 GB free of 58.17 GB	

13.3.2 Set Up Samba

1. In the **File Services** section, toggle on **Enable Samba**, and click **Apply**.

The screenshot shows the 'File Services' configuration page. At the top, there are three tabs: 'File Services', 'Shared Folders', and 'User Management'. Below the tabs, there are three sections: 'Samba', 'WebDAV', and 'DLNA'. Each section has a 'Quick Setup Share' link. The 'Samba' section has three toggle switches: 'Enable Samba' (turned on), 'Allow Access Samba from WAN' (turned off), and 'Enable Samba' (turned on). The 'WebDAV' section has one toggle switch: 'Enable WebDAV' (turned off). The 'DLNA' section has one toggle switch: 'Enable DLNA' (turned off). A red arrow points to the 'Apply' button at the bottom of the page.

- **Allow Access Samba from WAN:** Enable it if you want upstream devices to access the Samba service.

2. Click **Quick Setup Share** to set the shared link.

The screenshot shows the 'File Services' configuration page. At the top, there are three tabs: 'File Services', 'Shared Folders', and 'User Management'. Below the tabs, there are three sections: 'Samba', 'WebDAV', and 'DLNA'. Each section has a 'Quick Setup Share' link. The 'Samba' section has three toggle switches: 'Enable Samba' (turned on), 'Allow Access Samba from WAN' (turned off), and 'Enable Samba' (turned on). The 'WebDAV' section has one toggle switch: 'Enable WebDAV' (turned off). The 'DLNA' section has one toggle switch: 'Enable DLNA' (turned off). A red arrow points to the 'Quick Setup Share' link in the Samba section.

3. Add a user and click **Next**. This step will be skipped if you already have an account.

The screenshot shows the 'Add User' dialog box. It has a title bar with 'Add User' and a close button (X). Below the title bar, there are two input fields: 'User Name' with the value 'david' and 'Password' with a masked password (represented by dots) and a toggle for password visibility.

- Click the triangle icon to show all folders. Select a folder for sharing, or click the disk name (e.g., disk1_part1) if you want to share the whole disk. Then click **Next**.

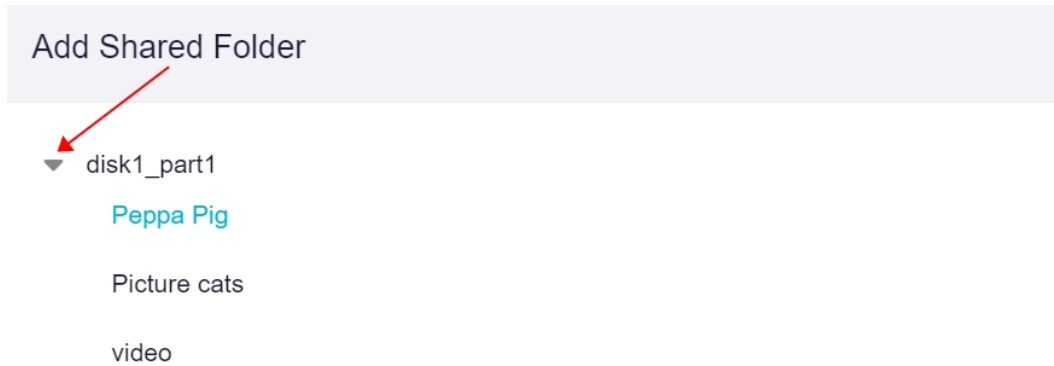

- Set up the shared folder.

For security reasons, it is not recommend to enable Anonymous Access.

The user created in the previous step will be added to **Read-Only User** by default. If you want this user to be able to write or delete files, remove it from Read-Only User and add it to **Writable User**, then click **Apply**.

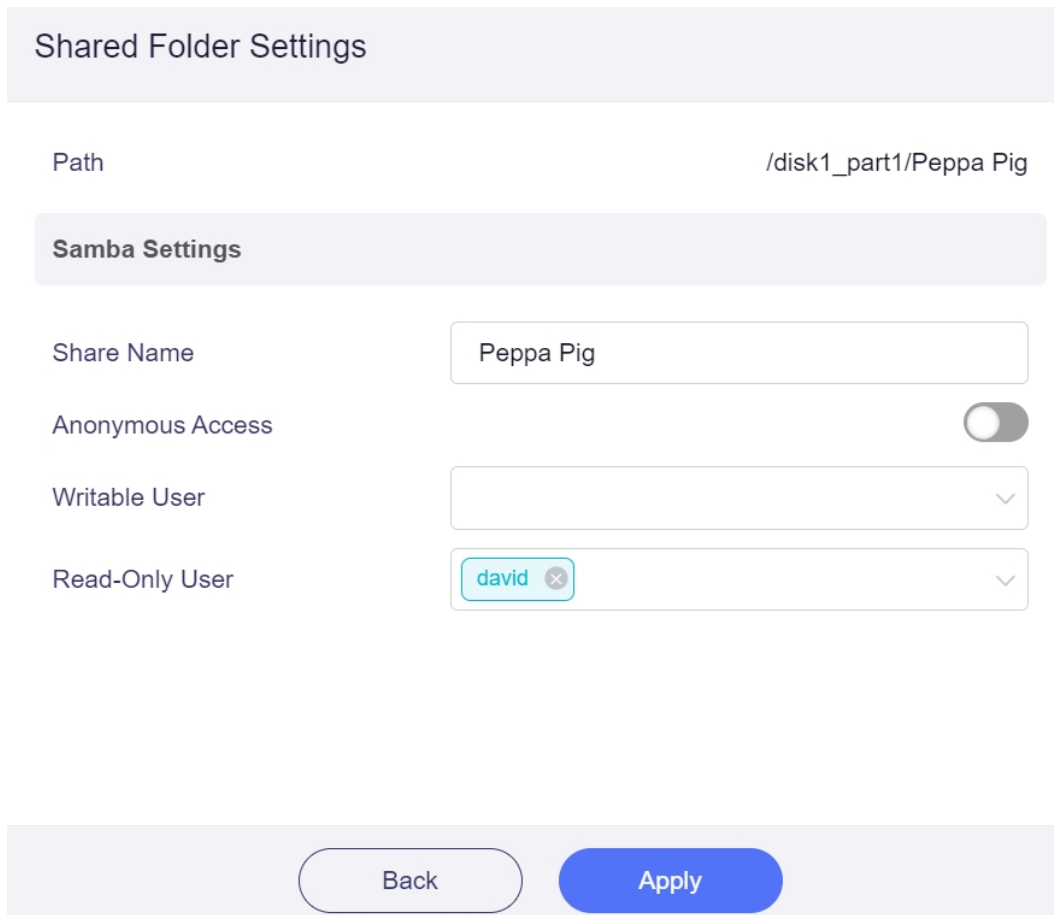

6. Obtain the folder access link.

The page will display the links for Windows and Unix-like OS. The Unix-like system includes Android, iOS, macOS, Ubuntu, etc. Now you can access your shared folder over Samba service via these links.

Folder Access Link

 The folder has been shared. Use the following link to mount the folder as a network disk to your PC or Phone. [Setup Guide](#)

Windows SMB

\\192.168.8.1\Peppa Pig

Unix-like Samba

smb://192.168.8.1/Peppa Pig

Note: If you enable **Allow Access Samba from WAN** and access the shared folder from upstream network, replace the router IP (default: 192.168.8.1) in the access link with your router's WAN IP, which can be found on the INTERNET page of the web admin panel.

13.3.3 Set Up WebDAV

1. In the **File Services** section, toggle on **Enable WebDAV**, and click **Apply**.

The screenshot shows the 'File Services' configuration page. At the top, there are three tabs: 'File Services' (selected), 'Shared Folders', and 'User Management'. Below the tabs, there are three main sections: Samba, WebDAV, and DLNA. The Samba section has a 'Quick Setup Share' link and an 'Enable Samba' toggle that is currently off. The WebDAV section has a 'Quick Setup Share' link, an 'Enable WebDAV' toggle that is turned on (indicated by a red arrow), and an 'Allow Access WebDAV from WAN' toggle that is off. Below these are two input fields: 'WebDAV Protocol' set to 'HTTPS' and 'WebDAV Port (HTTPS)' set to '6008'. The DLNA section has an 'Enable DLNA' toggle that is off. At the bottom of the page, there is a blue 'Apply' button with a red arrow pointing to it.

- **Allow Access WebDAV from WAN:** Enable it if you want the upstream devices to access the WebDAV service.
 - **WebDAV Protocol:** HTTP is unencrypted; use it at your own risk. HTTPS is encrypted and it uses self-signed certificate.
 - **WebDAV Port:** No need to modify the port number unless there's a conflict. The recommended port number range is 1024 - 65535.
2. Click **Quick Setup Share** to set the shared link.

The screenshot shows the 'WebDAV' configuration page. At the top, there is a 'Quick Setup Share' link with a red arrow pointing to it. Below this, there are three main sections: 'Enable WebDAV' (toggle is on), 'Allow Access WebDAV from WAN' (toggle is off), and 'WebDAV Protocol' (set to 'HTTP').

3. Add a user and click **Next**. This step will be skipped if you already have an account.

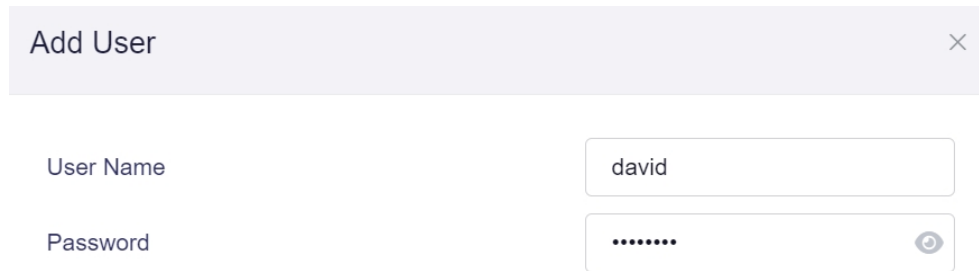

Add User

User Name

Password

4. Click the triangle icon to show all folders. Select a folder for sharing, or click the disk name (e.g., disk1_part1) if you want to share the whole disk. Then click **Next**.

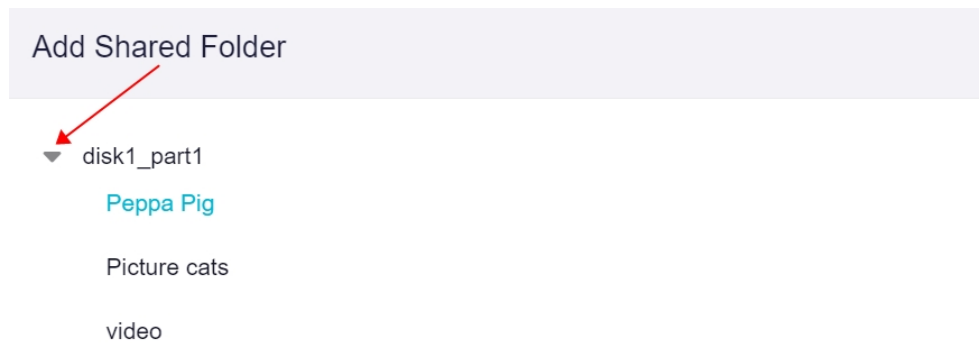

Add Shared Folder

▼ disk1_part1

- Peppa Pig
- Picture cats
- video



Cancel Next

5. Set up the shared folder.
For security reasons, it is not recommend to enable Anonymous Access.
The user created in the previous step will be added to **Read-Only User** by default.
If you want this user to be able to write or delete files, remove it from Read-Only User and add it to **Writable User**, then click **Apply**.

Shared Folder Settings

Path /disk1_part1/Peppa Pig

WebDAV Settings

Anonymous Access

Writable User

Read-Only User

Back

Apply

6. Obtain the folder access link.

The page will display the links for Windows and Unix-like OS. The Unix-like systems includes Android, iOS, macOS, Ubuntu, etc. Now you can access your shared folder over WebDAV service via these links.

Folder Access Link

 The folder has been shared. Use the following link to mount the folder as a network disk to your PC or Phone. [Setup Guide](#)

HTTPS https://192.168.8.1:6008/disk1_part1/Peppa Pig

Dav dav://192.168.8.1:6008/disk1_part1/Peppa Pig

Note: If you enable **Allow Access WebDAV from WAN** and access the shared folder from upstream network, replace the router IP (default: 192.168.8.1) in the access link with your router's WAN IP, which can be found on the INTERNET page of the web admin panel.

13.3.4 Set Up DLNA

1. In the **File Services** section, toggle on **Enable DLNA**, and click **Apply**.

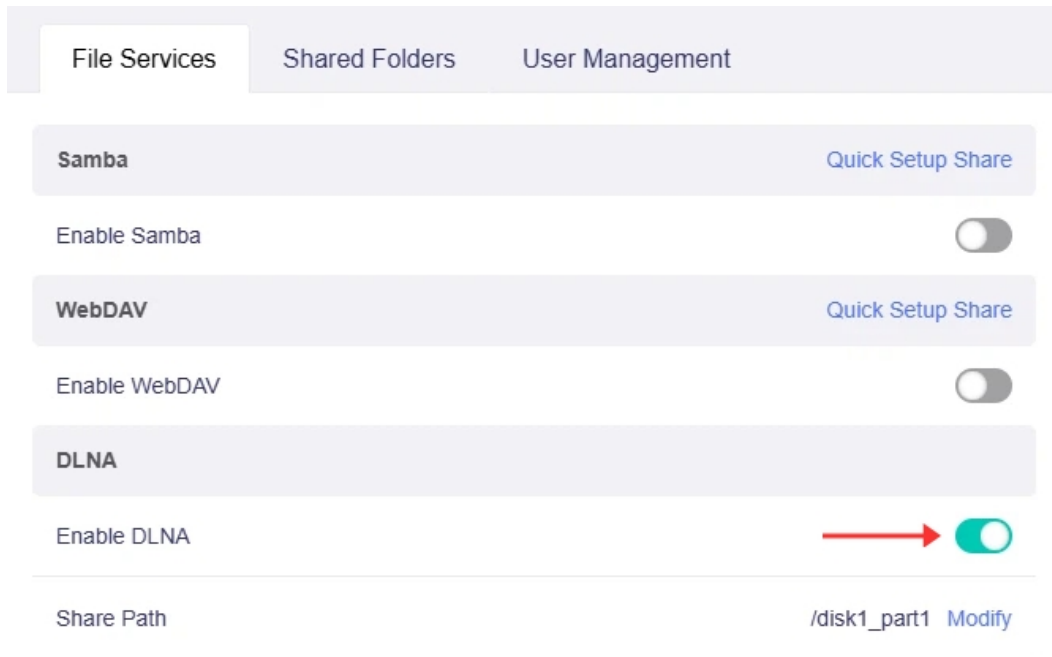

The screenshot shows a configuration interface with three tabs: "File Services", "Shared Folders", and "User Management". The "File Services" tab is active. It contains three sections: "Samba", "WebDAV", and "DLNA". Each section has a "Quick Setup Share" link and an "Enable" toggle switch. The "Enable DLNA" toggle is turned on and highlighted with a red arrow. Below the DLNA section, there is a "Share Path" field with the value "/disk1_part1" and a "Modify" link. At the bottom of the page, there is a blue "Apply" button highlighted with a red arrow.

2. Connect your smart TV to the router, and it will find the DLNA Server.

13.4 AdGuard Home

AdGuard Home is a network-wide ad-blocking and tracking-prevention software. Once set up, it will cover all client devices with no additional client-side software required.

Follow these steps to set up AdGuard Home.

1. Log in to the router's web admin panel, navigate to **APPLICATIONS > AdGuard Home**. Toggle on **Enable AdGuard Home** and click **Apply**.

AdGuard Home

AdGuard Home is network-wide software that blocks ads and tracking. Once set up, it will cover ALL the devices on your home network, there is no need for any additional client-side software. This page gets statistics through the API provided by AdGuard Home. When AdGuard Home is enabled, the router will force the use of DNS servers provided by AdGuard Home.

Enable AdGuard Home

AdGuard Home Handle Client Requests

Apply

- **AdGuard Home Handles Client Requests:** If enabled, DNS queries from client devices will be handled directly by AdGuard Home, but this will cause VPN policies based on domains to fail.
2. The page will automatically load DNS statistics (queries, blocked domains, etc.) via the API provided by AdGuard Home.

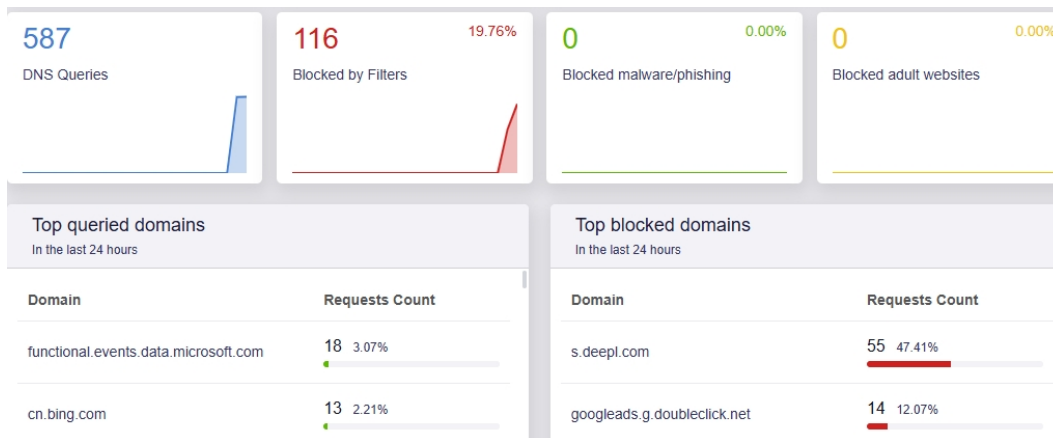

3. Click **Settings Page** to configure advanced settings for AdGuard Home.

AdGuard Home

AdGuard Home is network-wide software that blocks ads and tracking. Once set up, it will cover ALL the devices on your home network, there is no need for any additional client-side software. This page gets statistics through the API provided by AdGuard Home. When AdGuard Home is enabled, the router will force the use of DNS servers provided by AdGuard Home.

Please go to the [Settings Page](#) to perform advanced configuration of Adguard Home.

4. You will be redirected to AdGuard Home's settings page. Please visit the [AdGuard Home Support Center](#) for assistance.

The screenshot shows the AdGuard Home dashboard with the following sections:

- Dashboard:** Includes a "Disable protection" dropdown and a "Refresh statistics" button.
- Summary Cards:**
 - DNS Queries: 658
 - Blocked by Filters: 124 (18.84%)
 - Blocked malware/phishing: 0 (0%)
 - Blocked adult websites: 0 (0%)
- General statistics (for the last 24 hours):**

Category	Count
DNS Queries	658
Blocked by Filters	124
Blocked malware/phishing	0
Blocked adult websites	0
Enforced safe search	0
Average processing time	61 ms
- Top clients (for the last 24 hours):**

Client	Requests count
localhost (127.0.0.1)	658 100%
- Top queried domains (for the last 24 hours):**

Domain	Requests count
functionalevents.data.microsoft.com	21 3.19%
cn.bing.com	13 1.98%
api.nrd.nie.163.com	12 1.82%
nav-edge.smartscreen.microsoft.com	12 1.82%
- Top blocked domains (for the last 24 hours):**

Domain	Requests count
s.deepl.com	56 45.16%
googleads.g.doubleclick.net	14 11.29%
www.google-analytics.com	12 9.68%
static.doubleclick.net	6 4.84%

13.5 Parental Control

Parental control is a way to keep children safe online by blocking inappropriate websites and limiting how long they use devices. It helps prevent access to harmful content, manage screen time, and ensure children use the internet responsibly.

13.5.1 Quick Setup

Follow these steps to set up Parental Control on GL.iNet routers.

1. Log in to the router's web admin panel and go to **APPLICATIONS > Parental Control**. Ensure the router time is accurate. If not, go to **SYSTEM > Time Zone** to synchronize it first.

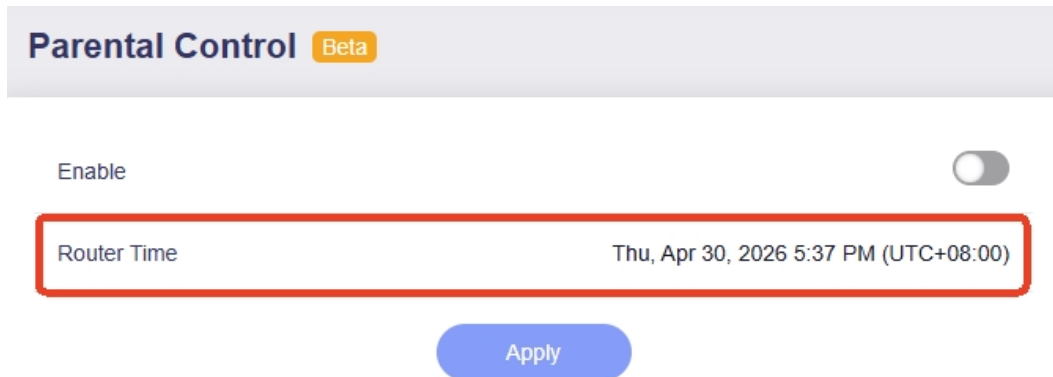

2. Enable Parental Control and click **Apply**. Then follow the setup wizard to set up Parental Control. You can also watch the setup video [here](#).

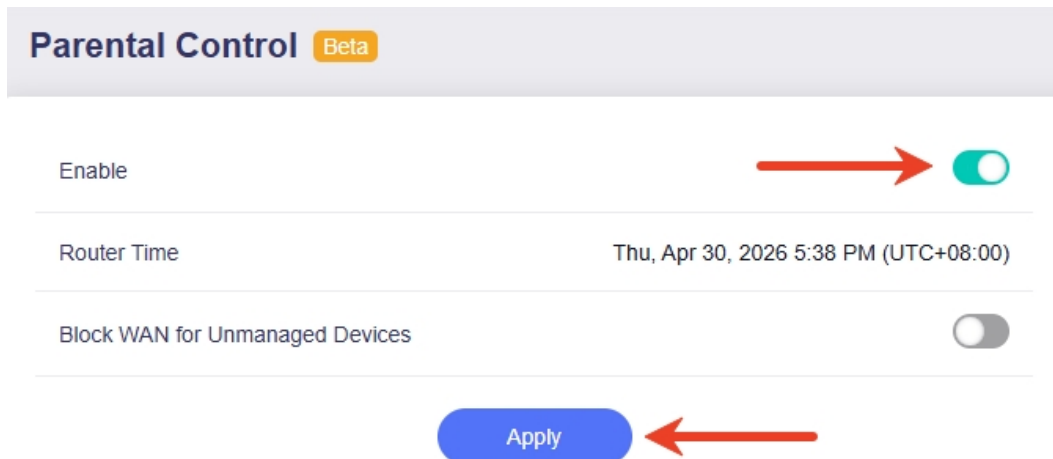

- **Block WAN for Unmanaged Devices:** Blocks internet access for all devices that are not on the Parental Control list.

Here is a use case for your reference.

Scenario: Devices in this profile are only allowed to access the Internet for study from 8 AM to 11 AM on weekdays, and for gaming from 6 PM to 8 PM on weekends. Internet access is blocked by default at all other times.

Setup Steps:

1. Create a profile and customize a name.

1. Create a profile for your child or family

First, select the client devices used by your children or your family, depending upon whether you want to control network access to all devices for your entire family or whether you want to control access for each child separately. After that, you can

1. block access to the Internet from all devices of your choice;
2. limit access to specific applications or sites to all devices of your choice.

You can name these devices, giving them a name that is easy to remember. If created for a specific child, you could use the child's name or nickname.

Rule Name

2. Select the devices you want to manage. Connect them to the router first. If they have not been connected to the router, add them manually by entering their MAC addresses.

2. Select the devices to be managed



You should first connect these devices to the router as clients. Otherwise you will need to enter the individual MAC addresses manually.

[+ Manually Add Device](#)

glkvm
94:83:C4:A9:97:DC

GL-INET-08
6C:1F:F7:5D:F1:5D self

Child-phone
94:83:C4:B7:20:01

3. Set access limit.

There are two default rulesets: **Block Internet Access** and **No Limit**.

Click **Add a New Ruleset** to create two more rulesets for later use: **Learning** and **Play**.

3. Set access limits for these devices ×

Next, you can set how to limit access to the Internet for these devices.

1. you can prevent these devices from connecting to the Internet and then pause the restriction at a specific time;
2. you can also block access from these devices to specific applications or Internet sites to prevent your child from accessing or viewing content that you consider is not suitable for them.

You can create a new ruleset to block applications or sites that you do not want to be accessed.

Default Ruleset ● Block Internet Access

+ Add a New Ruleset

Specify the ruleset name (e.g., Learning) and color, enter the websites to block, then click **Apply**.

Add a New Ruleset

Ruleset Name

Color

Blocklist Input Mode ⓘ ▼

1	fortnite.com
2	pornhub.com
3	tiktok.com

Note: The domain names entered in the blocklist should include their subdomains. For example, if "example.com" is entered, it also includes any subdomain, such as "subdomain.example.com".

Similarly, create another ruleset. Specify the ruleset name (e.g., Play) and color, enter the websites to block, then click **Apply**.

Add a New Ruleset

Ruleset Name

Color

Blocklist Input Mode ⓘ

1

Upon applied, there will be a total of four rulesets. Select **Block Internet Access** as the **Default Ruleset**, and click **Finish**.

3. Set access limits for these devices ×

Next, you can set how to limit access to the Internet for these devices.

1. you can prevent these devices from connecting to the Internet and then pause the restriction at a specific time;
2. you can also block access from these devices to specific applications or Internet sites to prevent your child from accessing or viewing content that you consider is not suitable for them.

You can create a new ruleset to block applications or sites that you do not want to be accessed.

Default Ruleset

Block Internet Access

No Limit

Learning

Play

4. Next, set schedule for your profile. Click **Go to Set**.

4. Go to set schedules

You have successfully created a profile!

If you need to specify a more detailed schedule for your child or your family, to include times for study, times for playing games or when it is time for bed; you can make additional schedule settings.



Later

Go to Set

Add the **Learning** ruleset to the schedule. Set the **Execution Time** from 8 AM to 11 AM on weekdays, then click **Apply**.

Add Schedule



You can set up special time slots during which the device will be subject to additional restrictions. For example, you can define playtimes where you allow your child to play; free time slots at weekends or times when your child needs to take a break.

Schedule Ruleset

Learning

Execution Time

08:00

to

11:00

Execution Day(s)

Sun

Mon

Tue

Wed

Thu

Fri

Sat

Cancel

Apply

5. You will be redirected to the edit page of the created profile.

Parental Control / Modify Profile Beta

ⓘ Each client device can only be assigned to one profile. If you add a client device to another profile, it will be removed from the original one.

Rule Name

Home

Default Ruleset ⓘ

● Block Internet Acce: ▾

Devices

[+ Manage Device](#)

📱 Child-phone

Apply

Move to the bottom, and you will see that a schedule has been created. Click the gear icon in the upper right and select **Add Schedule**.

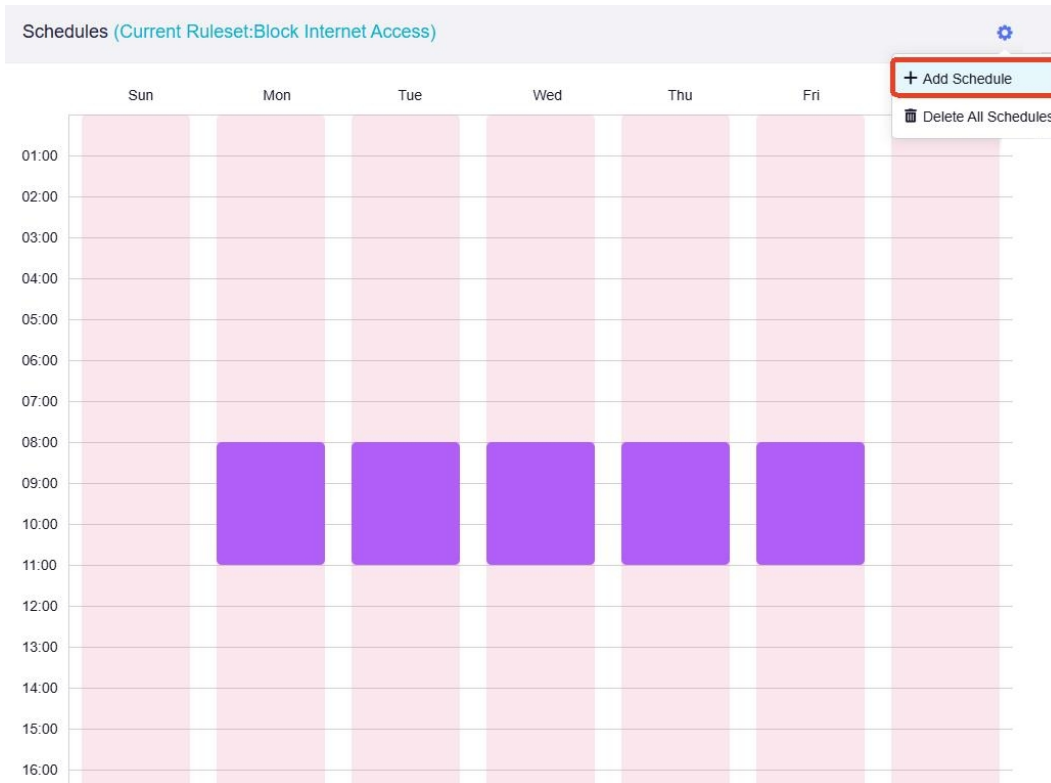

6. Add another ruleset **Play** to the schedule. Set the **Execution Time** from 6 PM to 8 PM on weekends, then click **Apply**.

Add Schedule



You can set up special time slots during which the device will be subject to additional restrictions. For example, you can define playtimes where you allow your child to play; free time slots at weekends or times when your child needs to take a break.

Schedule Ruleset

● Play

Execution Time

🕒 18:00

to

🕒 20:00

Execution Day(s)

Sun

Mon

Tue

Wed

Thu

Fri

Sat

Cancel

Apply

The Play ruleset will then be added into the schedule.

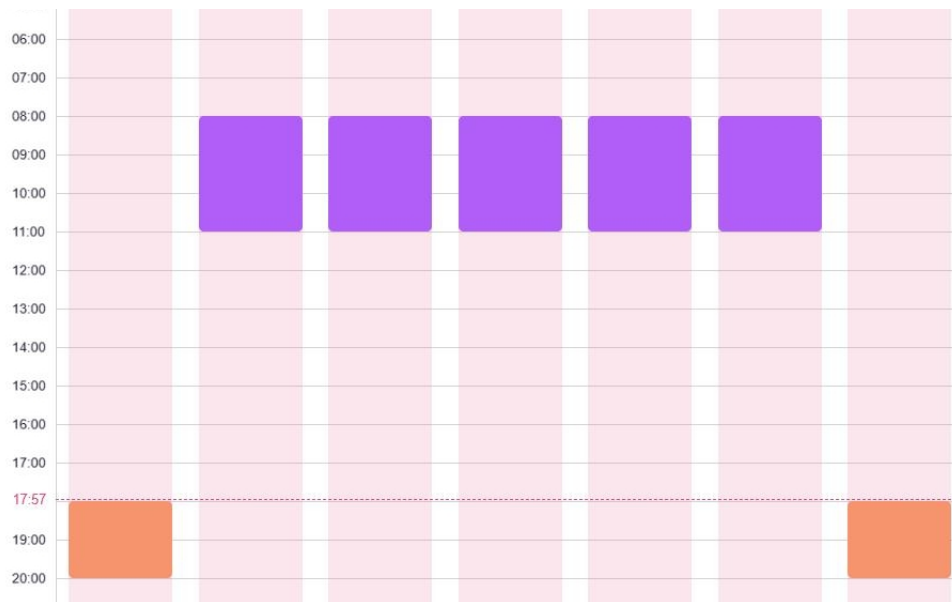

Tips:

- The red dashed line indicates the current time.
- You can modify the execution time by clicking on a certain ruleset in the schedule.

7. Click **Parental Control** at the top to return to the Parental Control page.

Parental Control / **Modify Profile** Beta

i Each client device can only be assigned to one profile. If you add a client device to another profile, it will be removed from the original one.

Rule Name

Home

Default Ruleset **i**

Block Internet Acce: ▾

You will see the final configuration. Parental Control is now taking effect as per the schedule. You can modify existing profiles and rulesets, or add new ones as needed.

Profiles

i You can create a profile for each of your children and add the client devices that they use. Then you can set different schedules within each profile based on the learning times, bedtimes etc. that you have set for them. These schedules will control which websites and applications the devices in the device group can access at the times you have specified.

Add

Home (1)



Name

Child-phone

Block Internet Access

Switch to Learning after 13 Hours 58 Minutes

ruleset

i You can define rulesets for specific time periods, to limit which websites and apps your child is allowed access to. For example, "learning time" does not allow access to specific video websites or apps. You can assign the ruleset that is to be used at which time period in the schedule of each profile.

Add

Ruleset Name	Description	Action
Block Internet Access	Drop all Internet connections	system
No Limit	Accept all Internet connections	system
Learning	Block access to 3 sites	...
Play	Block access to 1 sites	...

13.5.2 Troubleshooting

If your configured settings fail to take effect, check the following possible causes.

1. DNS cache issue.

Browsers and operating systems maintain DNS caches, which may delay the application of configuration changes. Clear the DNS cache to apply changes immediately.

2. The profile schedule has not yet started.
3. The entered domain name may be incorrect.

While a website's public domain is easy to find, the API domains used by apps are often not publicly available. To locate the correct domain, use a packet capture tool such as Wireshark or look up the relevant domain information.

For example, when blocking "www.google.com", entering "google.com" delivers better results than "www.google.com".

4. The target device uses a randomized MAC address for each network connection, which prevents access rules from taking effect. Disable random MAC address on the target device, then re-add the device to your profile.

13.6 Tailscale

Tailscale is a VPN service that makes your personal devices and applications accessible worldwide, securely and effortlessly. See [here](#) for more details.

The Tailscale feature on GL.iNet routers allows the router to join a Tailscale virtual network, enabling remote access to the router itself, as well as its WAN and LAN-side resources.

Note:

1. Since Tailscale is based on WireGuard, it is not recommended to use Tailscale with any of the following features or services simultaneously, as this may cause routing conflicts: OpenVPN Client, WireGuard Client, GoodCloud Site to Site, ZeroTier, AstroWarp.
2. This feature is currently in beta, and may have some bugs.
3. GL.iNet routers are not yet available as exit nodes.

13.6.1 Set Up Tailscale

Here is an example of using GL-MT2500 to set up Tailscale network.

1. Register a Tailscale account first and bind one or two devices to your Tailscale account for testing purposes. After binding, you will see your devices in the Tailscale Console.

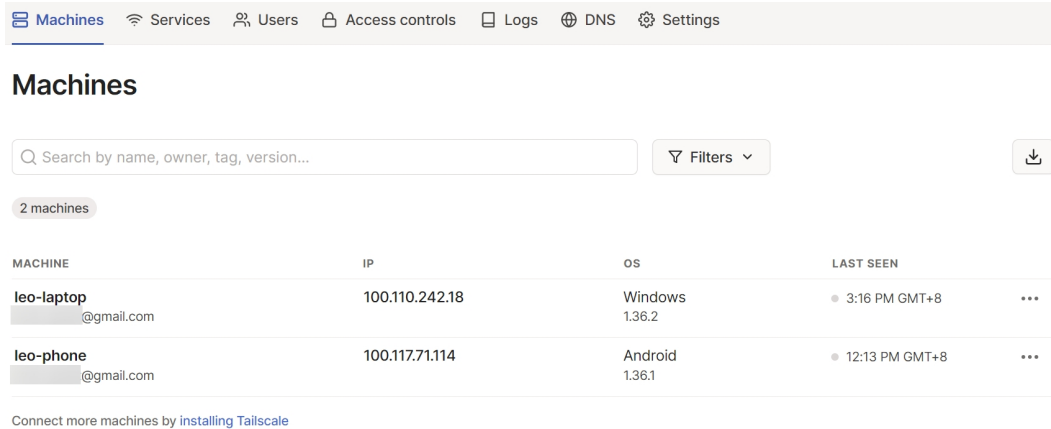

2. Log in to your router's web admin panel and navigate to **APPLICATIONS > Tailscale**. Toggle on **Enable Tailscale** and click **Apply**.

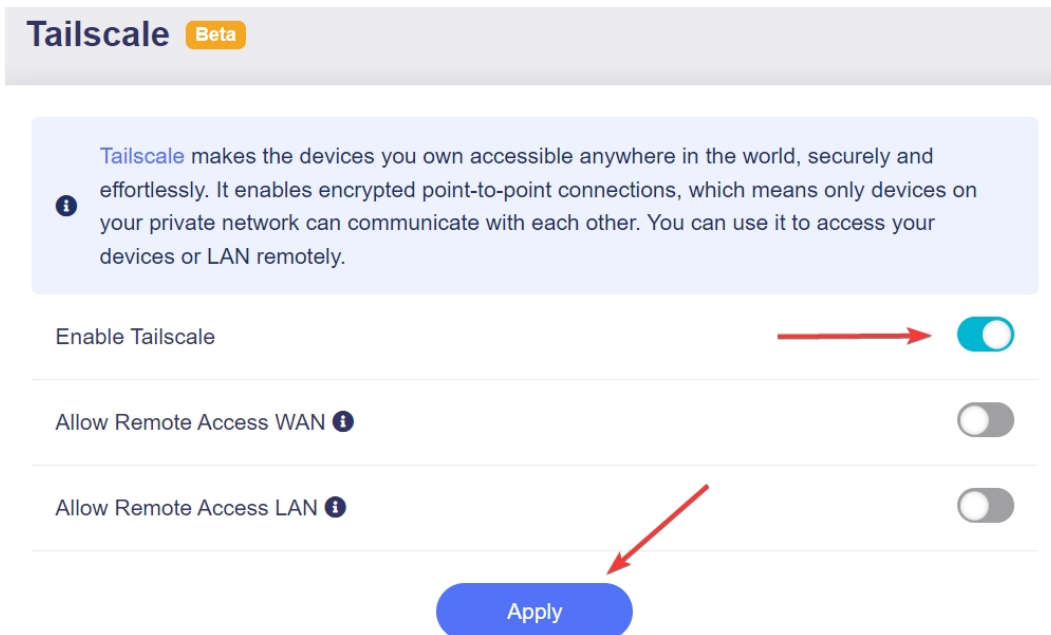

3. The page will prompt you to bind the device. Click **Device Bind Link**.

Tailscale Beta

i Tailscale makes the devices you own accessible anywhere in the world, securely and effortlessly. It enables encrypted point-to-point connections, which means only devices on your private network can communicate with each other. You can use it to access your devices or LAN remotely.

The Tailscale service is enabled, but the device is not bound yet. Please bind this device to your Tailscale account using [The Device Bind Link](#).

Enable Tailscale



4. In the pop-up window, click the link and log in with your Tailscale account.

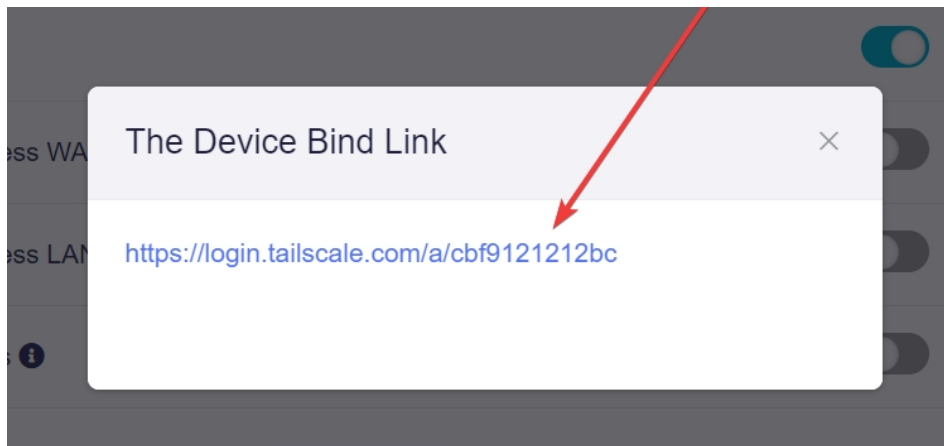

5. Once logged in, you will be asked to confirm the device. Click **Connect**.



Connect device

Do you want to connect the device GL-MT2500 to the [redacted]@gmail.com tailnet? This may give the device access to other resources in your tailnet, based on ACLs.

► Device details

Connect

- You will then be redirected to the Tailscale admin console. Now the router has been added into the Tailscale virtual network, and it can be accessed remotely by the Tailscale virtual IP 100.88.54.21.

The screenshot shows the Tailscale admin console interface. At the top, there is a navigation bar with links for Machines, Services, Users, Access controls, Logs, DNS, and Settings. Below the navigation bar, the title 'Machines' is displayed. A search bar and a 'Filters' dropdown are present. A badge indicates '4 machines'. The main content is a table with the following data:

MACHINE	IP	OS	LAST SEEN
gl-mt2500 @gmail.com	100.88.54.21	Linux 1.32.2-dev-t	Connected
leo-desktop @gmail.com	100.119.150.32	Windows 1.36.2	Connected
leo-laptop @gmail.com	100.110.242.18	Windows 1.36.2	Mar 8, 9:31 PM GMT+8
leo-phone @gmail.com	100.117.71.114	Android 1.36.1	Connected

At the bottom of the table, there is a link: 'Connect more machines by installing Tailscale'.

- Test connectivity.

On another device connected to the same Tailscale network, open a web browser and enter the router's virtual IP in the address bar. If you can access the router's web admin panel, it means Tailscale is working. You can also use the ping command or SSH log in to the router's terminal by its virtual IP to test connectivity.

13.6.2 Allow Remote Access WAN

If this option is enabled, resources on the device's WAN side can be accessed through the Tailscale virtual network. See [here](#) for more details.

Tailscale Beta

Tailscale makes the devices you own accessible anywhere in the world, securely and effortlessly. It enables encrypted point-to-point connections, which means only devices on your private network can communicate with each other. You can use it to access your devices or LAN remotely.

The device is connected to your Tailscale virtual network.

Enable Tailscale

Allow Remote Access WAN i

Allow Remote Access LAN i

13.6.3 Allow Remote Access LAN

If this option is enabled, resources on the device's LAN side can be accessed through the Tailscale virtual network. See [here](#) for more details.

Tailscale Beta

Tailscale makes the devices you own accessible anywhere in the world, securely and effortlessly. It enables encrypted point-to-point connections, which means only devices on your private network can communicate with each other. You can use it to access your devices or LAN remotely.

The device is connected to your Tailscale virtual network.

Enable Tailscale

Allow Remote Access WAN i

Allow Remote Access LAN i

13.6.4 Custom Exit Nodes

By default, Tailscale acts as an overlay network: it only routes traffic between devices running Tailscale, and does not process your public Internet traffic — such as when browsing websites like Google.

However, there might be times when you want Tailscale to route your public Internet traffic. For example, when you are away from home or traveling abroad, if you need to access online services (such as banking) that are only available in your home country, you can set your home desktop with a public IP as an Exit node, and configure other devices on the same Tailnet — such as the GL-AXT1800 and GL-MT3000 in the image below — to send their traffic through it. This enables all your public Internet traffic to be forwarded via the Exit Node.

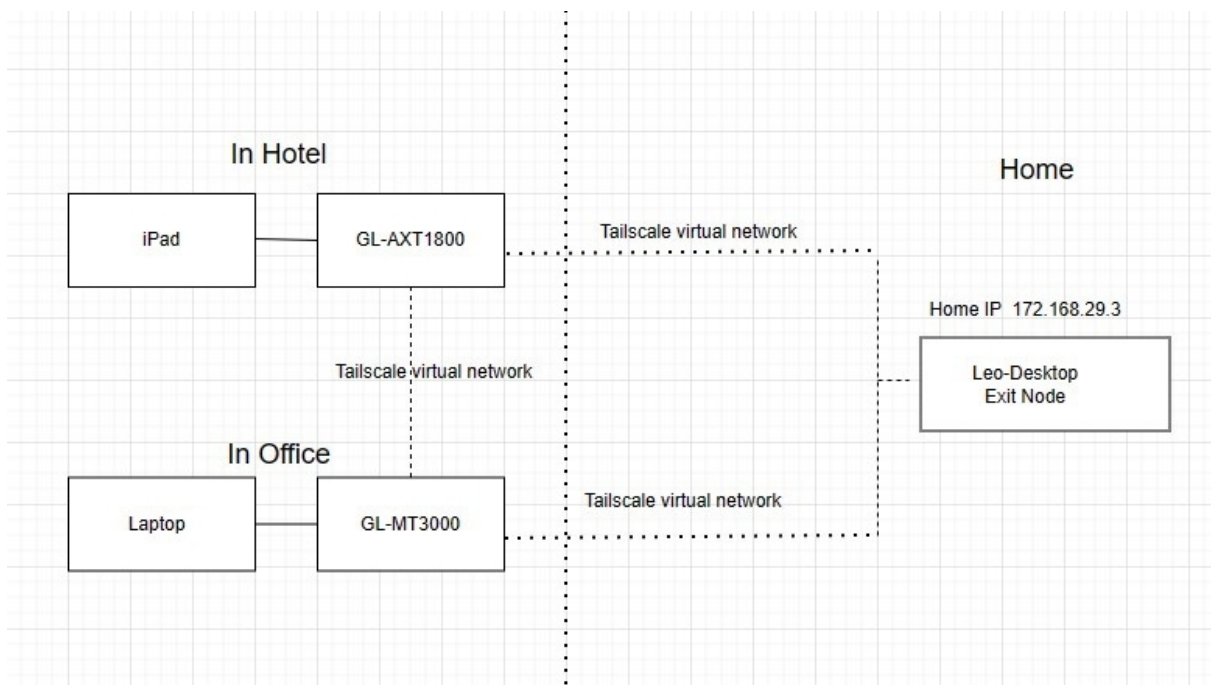

In summary, an Exit node routes outbound Internet traffic from your Tailnet devices, effectively acting as VPN servers. When connected to an Exit node, all your non-Tailscale Internet traffic appears to originate from its location, helping you access geo-restricted content and enhance your online privacy. The device handling this traffic forwarding is referred to as an "exit node". See [here](#) for more details.

Note: If the router's DNS Server is a private IP address that can be accessed only in the local network, you may lose Internet access when running the exit nodes. To avoid this, please set a public DNS server (e.g., 8.8.8.8) manually for your router.

13.7 ZeroTier

ZeroTier is a software-based virtual private network (VPN) that enables secure, encrypted communications between devices over the internet. It creates a private, virtual network that allows devices to communicate as if they were on the same local network, regardless of their physical location or network topology. ZeroTier is designed to be easy to set up and use, and offers features such as end-to-end encryption, network segmentation, and network bridging capabilities.

The ZeroTier feature on GL.iNet routers allows the router to join a ZeroTier virtual network, enabling remote access to the router itself, as well as its WAN and LAN-side resources.

Note:

1. It is not recommended to use ZeroTier simultaneously with any of the following features or services, as this may cause routing conflicts: OpenVPN Client, WireGuard Client, GoodCloud Site to Site, Tailscale, and AstroWarp.
2. This feature is currently in beta, and may have some bugs.

13.7.1 Set Up ZeroTier

Two versions of ZeroTier Central are available: New Central and Legacy Central.

The following steps use New Central as an example.

1. Visit [ZeroTier official website](#) and sign in with your account.
2. Create an organization.

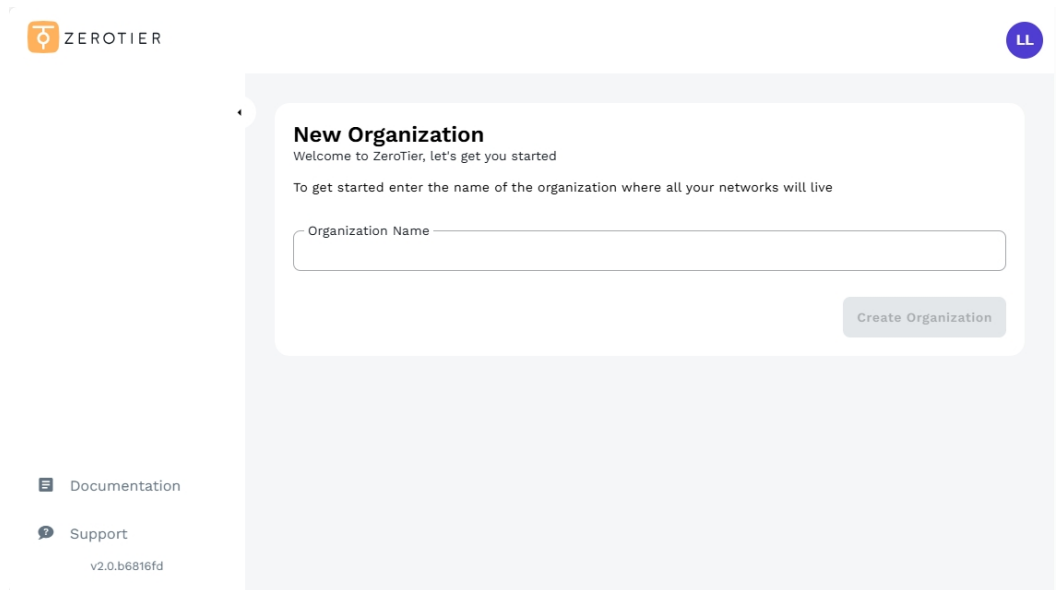

3. Select a plan. Here we choose **Personal plan** as an example, which includes 10 devices, 1 network admin, and 1 network. If you need to create more networks, add more devices, or add custom routes and DNS, choose other paid plan.
4. Now your ZeroTier network has been created.

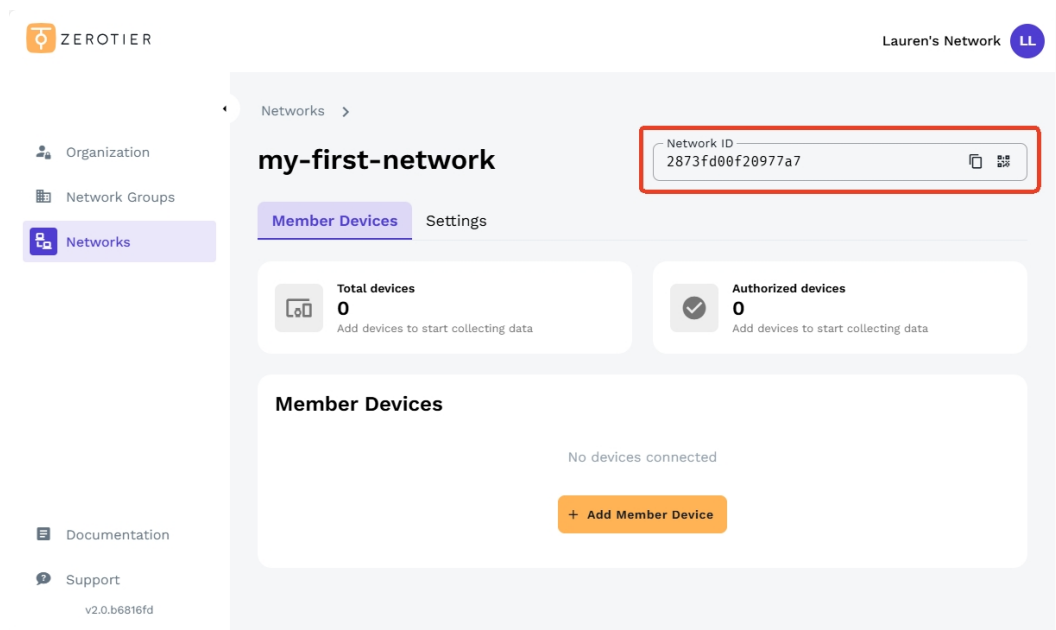

Take note of the **Network ID**, which is a 16-character alphanumeric combination in the upper right corner, as it will be required when connecting other devices later.

5. Log in to your router's web Admin Panel and navigate to **APPLICATIONS** -> **ZeroTier**. Enable ZeroTier, enter the **Network ID**, then click **Apply**.

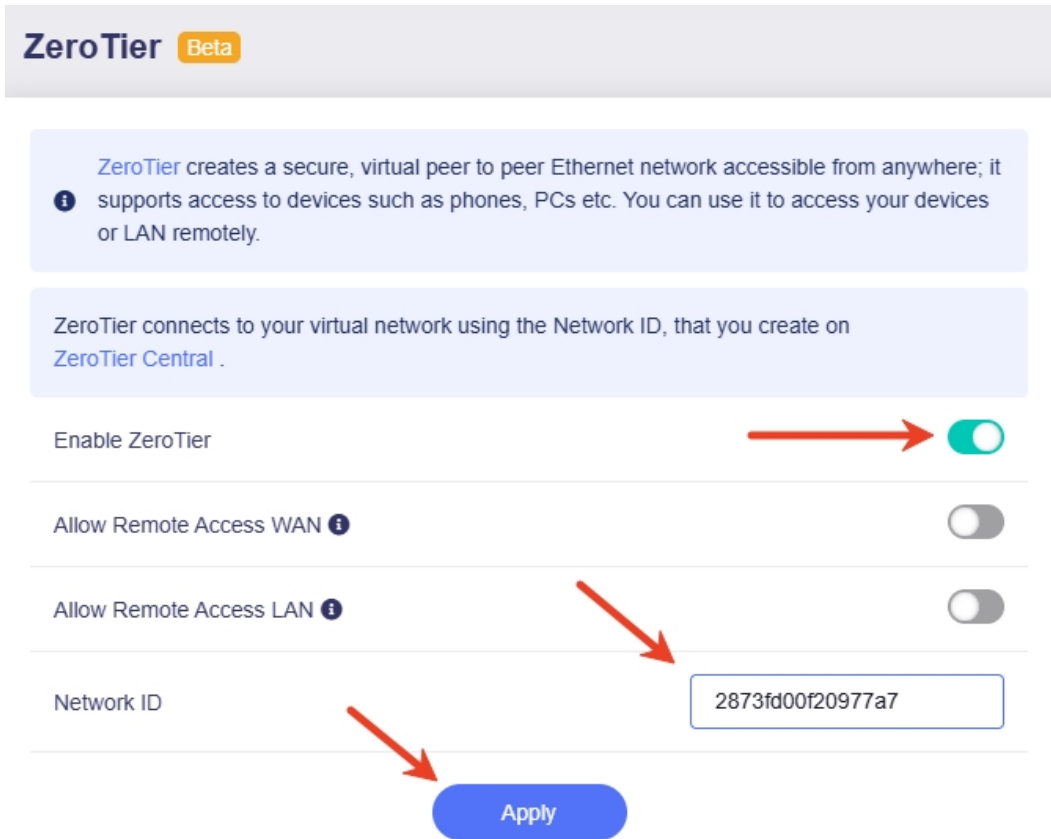

After a short while, the page will indicate that authorization is required. Click the **ZeroTier Central** hyperlink to redirect to the ZeroTier Central.

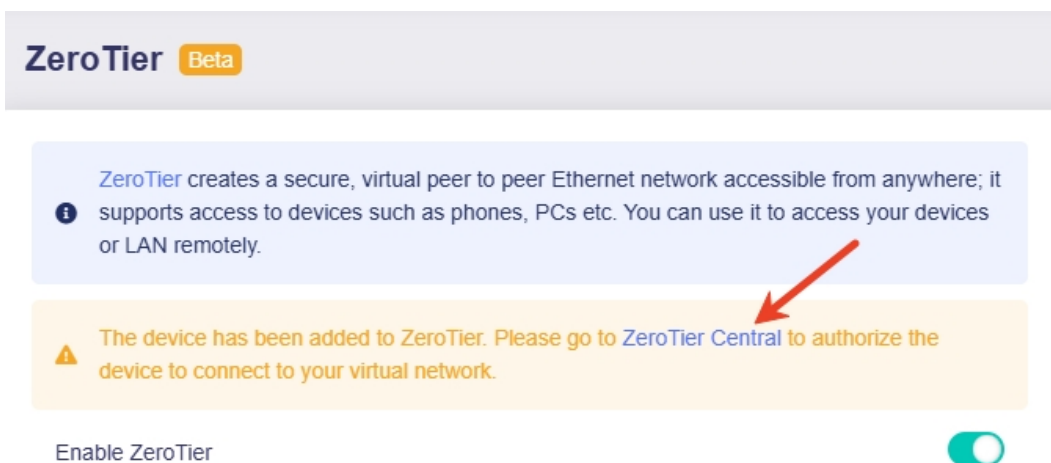

6. On the ZeroTier Central, locate the Pending device and authorize it.

The screenshot shows the ZeroTier dashboard for a network named "my-first-network". At the top right, the user is identified as "Lauren's Network". The network ID is "2873fd00f20977a7". Below the network name, there are tabs for "Member Devices" and "Settings". A blue banner at the top indicates "Device Pending Authorization" with a sub-message: "A device is waiting for approval. Authorize or Reject here or in the table below (actions)". To the right of this banner are two buttons: "Authorize" (with a checkmark icon) and "Reject" (with an 'X' icon). A red arrow points to the "Authorize" button. Below the banner, there are two summary cards: "Total devices" with a count of 1, and "Authorized devices" with a count of 0. The "Member Devices" section includes a search bar, a "Show Rejected" toggle, and an "Add Member Device" button. A table below lists the member devices:

Device ID	Name	Status	ZT IP	Public IP	ZT Version	Last Active	Actions
eb618be42d	—	Not Authorized		183.178.54.242/30149	unknown Linux	a few seconds ago	...

Once authorized, the page displays as follows.

The screenshot shows the ZeroTier dashboard for the same network "my-first-network". The "Device Pending Authorization" banner is no longer present. The "Total devices" card now shows a count of 1, and the "Authorized devices" card also shows a count of 1. In the "Member Devices" table, the device "eb618be42d" now has a status of "Authorized" (indicated by a green checkmark icon).

Device ID	Name	Status	ZT IP	Public IP	ZT Version	Last Active	Actions
eb618be42d	—	Authorized	10.206.245.46	183.178.54.242/24364	V1.14.1 Linux	a few seconds ago	...

7. Add another device (such as a computer or smartphone) to the same ZeroTier network by following [this guide](#). Once successfully added, the page displays as follows. You will see the details of member devices, such as **Device ID**, **Name**, **Status**, **Managed IP**, and **Public IP**.

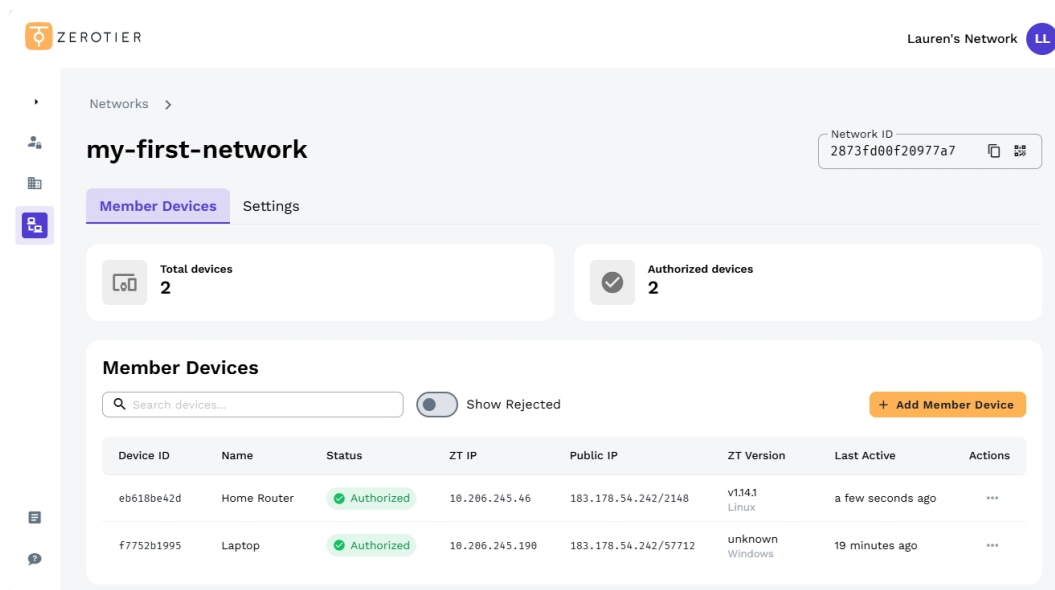

Tip: You can click the three-dot icon on the right to edit member device settings, including the device name, Managed IP(s), and advanced settings.

8. Click the router's **Managed IP** to copy it.

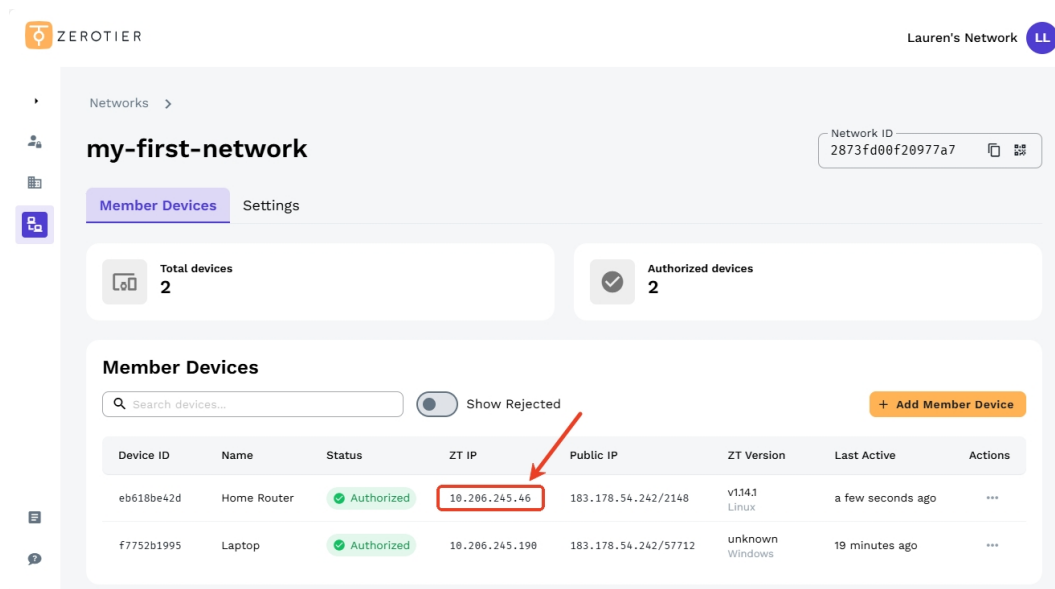

You can then use this Managed IP to access the router from your laptop that is on the same ZeroTier network.

9. Test connectivity.

On the laptop connected to the same ZeroTier network, open a web browser and enter the router's Managed IP obtained in the previous step. If you can access the router's web Admin Panel, the ZeroTier connection is successful.

13.7.2 Allow Remote Access WAN

If this option is enabled, resources on the device's WAN side can be accessed through the ZeroTier virtual network. See [here](#) for more details.

ZeroTier Beta

ZeroTier creates securely peer to peer virtual Ethernet networks that work anywhere and supports access to devices such as phones, PCs etc. You can use it to access your devices or LAN remotely.

The device is connected to your ZeroTier virtual network.

Enable ZeroTier

Allow Remote Access WAN

Allow Remote Access LAN

Note: This feature requires routing rules to be added to the ZeroTier network to take effect. One custom route can be added for free in Legacy Central, while in New Central you can only configure custom routes with an Essential plan or higher. See [here](#) for pricing details.

13.7.3 Allow Remote Access LAN

If this option is enabled, resources on the device's LAN side can be accessed through the ZeroTier virtual network. See [here](#) for more details.

ZeroTier Beta

i ZeroTier creates securely peer to peer virtual Ethernet networks that work anywhere and supports access to devices such as phones, PCs etc. You can use it to access your devices or LAN remotely.

The device is connected to your ZeroTier virtual network.

Enable ZeroTier



Allow Remote Access WAN **i**



Allow Remote Access LAN **i**



Note: This feature requires routing rules to be added to the ZeroTier network to take effect. One custom route can be added for free in Legacy Central, while in New Central you can only configure custom routes with an Essential plan or higher. See [here](#) for pricing details.

Chapter 14

Network

This chapter introduces network-related settings for configuration and management, such as LAN, DNS, and IPv6.

14.1 Port Forwarding

Port forwarding is a network feature that routes external requests to specific devices on your local network. The Port Forwarding page includes two key functions: **DMZ** (for direct full access to a single device) and **Port Forwarding** (for targeted access to specific ports of devices).

14.1.1 DMZ

DMZ allows you to expose one computer to the Internet, so all inbound packets will be redirected to this computer.

Follow the steps below to enable DMZ as needed.

1. Log in to your router's web admin panel and navigate to **NETWORK > Port Forwarding > DMZ** section.
2. Toggle on **Enable DMZ**. Select the Priority and DMZ Host IP from the drop-down list, and click **Apply**.

DMZ

i DMZ lets you to expose one local computer to the Internet, all inbound packets will be redirected to this computer.

Enable DMZ

Priority

DMZ Host IP

Apply

- **Priority:** Set it as Highest or Lowest. If the priority of the DMZ is higher than the port forwarding rules, all port forwarding rules will be invalidated. Otherwise, requests will be forwarded to the DMZ client device only if the accessed port has no corresponding port forwarding rule.
- **DMZ Host IP:** Select the internal IP address of the device that will receive all the inbound packets.

14.1.2 Port Forwarding

Port Forwarding enables remote computers to connect to a local computer or server behind the LAN firewall (e.g., web servers, FTP servers).

If you need to set up port forwarding, follow the steps below.

1. Log in to your router's web admin panel, go to **NETWORK > Port Forwarding > Port Forwarding** section, and click **Add**.

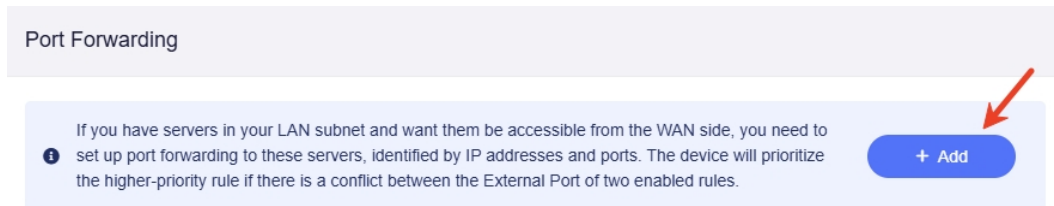

2. In the pop-up window, enter or select the required parameters from the drop-down list to add a port forwarding rule, then click **Apply**.

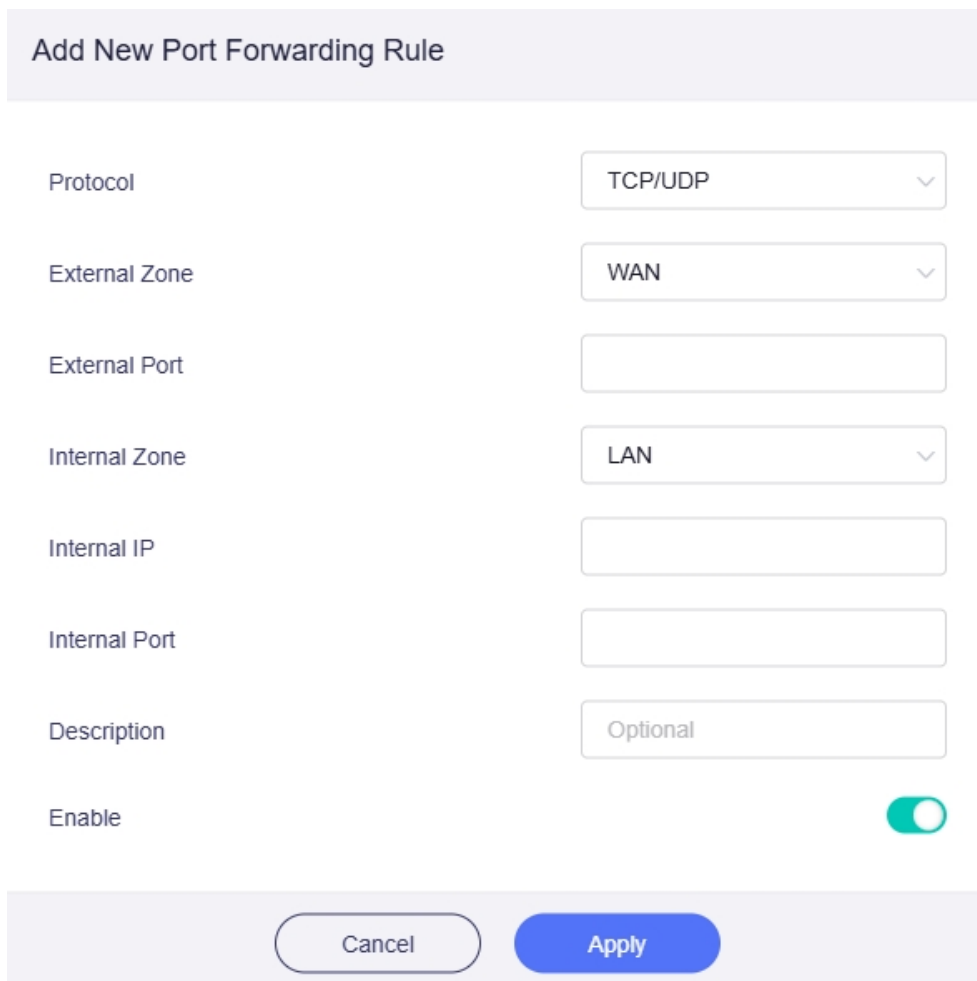

- **Protocol:** The protocol used. You can choose TCP, UDP, or both TCP and UDP.
- **External Zone:** Available options are WAN, WireGuard Client, WireGuard Server, OpenVPN Client, OpenVPN Server, LAN, and Guest.
- **External Port:** The number(s) of external ports. Enter a specific port number here. The port range is 1–65535. You can set a single port or a port range by concatenating the first and last port numbers with a hyphen (e.g., 501-510).
- **Internal Zone:** Available options are LAN, Guest, WireGuard Client, WireGuard Server, OpenVPN Client, OpenVPN Server, and WAN.
- **Internal IP:** The IP address assigned by the router to the device that needs remote access. If you set a single port in External Port, set a single port here. If you set a port range in External Port, set the corresponding port range here.
- **Internal Port:** The internal port number of the device. Enter a specific port number. Leave it blank if it matches the external port.
- **Description:** Set a name or add a description for the port forwarding rule (optional).
- **Enable:** Enable or disable this rule.

14.2 Multi-WAN

Multi-WAN enables simultaneous use of multiple Internet access methods, allowing configuration of diverse connectivity options on the router. It offers two working modes:

- **Failover:** Automatically switches to an alternate connection within a short time if the primary connection fails, ensuring uninterrupted network access.
- **Load Balance:** Distributes network traffic across all available connections at a set ratio for concurrent multi-connection usage, optimizing bandwidth utilization.

Log in to your router's web admin panel and navigate to **NETWORK > Multi-WAN**. This page includes two sections: Interface Status Track and Multi-WAN Mode.

14.2.1 Interface Status Track

GL.iNet routers use the **ping** command to monitor the connection status to the destination IP and determine if the interface is available. If the interface is available, a green dot will be displayed on the left; otherwise it will be gray.

Interface Status Track

i The router tracks the status of the connection to the destination IP to establish whether the interface is available.

<input checked="" type="checkbox"/> Ethernet 1	ping
<input type="checkbox"/> Repeater	ping
<input type="checkbox"/> Tethering	ping
<input type="checkbox"/> Cellular	Low Data Mode ping
<input type="checkbox"/> Ethernet 2	ping

In the **Interface Status Track** section, click the gear icon on the right to access the status tracking settings for each network interface. Below are the status tracking settings for the Ethernet interface. The same configuration logic applies to other interfaces.

Ethernet 1 Status Track

Enable Interface Status Track 



Detection Mode 

Normal



Track Command

ping



IPv4 Track IP

1.1.1.1

8.8.8.8

208.67.222.222

208.67.220.220

Cancel

Apply

- **Enable Interface Status Track:** It is enabled by default. If disabled, the router will determine the interface status based on physical conditions (e.g., whether the Ethernet cable is plugged in).
- **Detection Mode:** This feature was introduced as Low Data Mode in firmware v4.5, then renamed Detection Mode in firmware v4.7. Three modes are available: Normal Mode, Low Data Mode, and Strict Mode.
 - **Normal Mode:** It is used by default.
 - **Low Data Mode:** It only triggers tracking when a network error occurs on the network interface. Use this mode if you are on a limited data plan. Note that reconnecting after a disconnection may be slightly slower than in Normal Mode, and it is enabled by default only for cellular interface.
 - **Strict Mode:** It determines the interface status exclusively based on the results of a detection command sent to a public IP.

- **Track Command:** The ping command is used to monitor connection status to the destination IP and verify interface availability.
- **IPv4 Track IP:** Customize the IPv4 Track IP addresses as needed.

Click **Sensitivity Options** in the upper right corner.

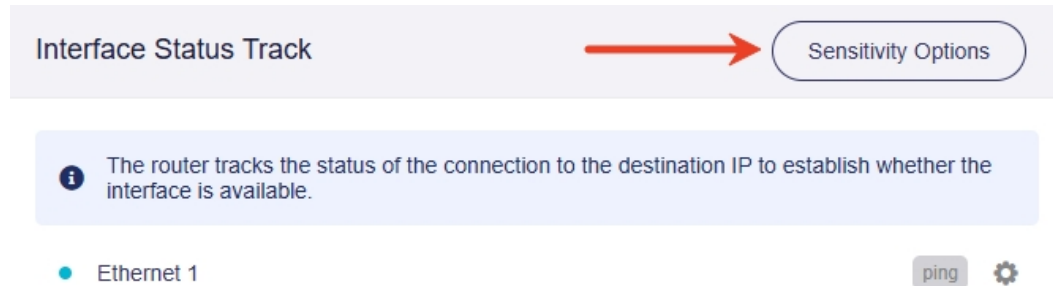

Interface Status Track

Sensitivity Options

The router tracks the status of the connection to the destination IP to establish whether the interface is available.

Ethernet 1 ping

You can set the time interval for Internet status detection to Low, Medium, High, or customize it. The adjustable interval time ranges from 0.5 seconds to 90 seconds.

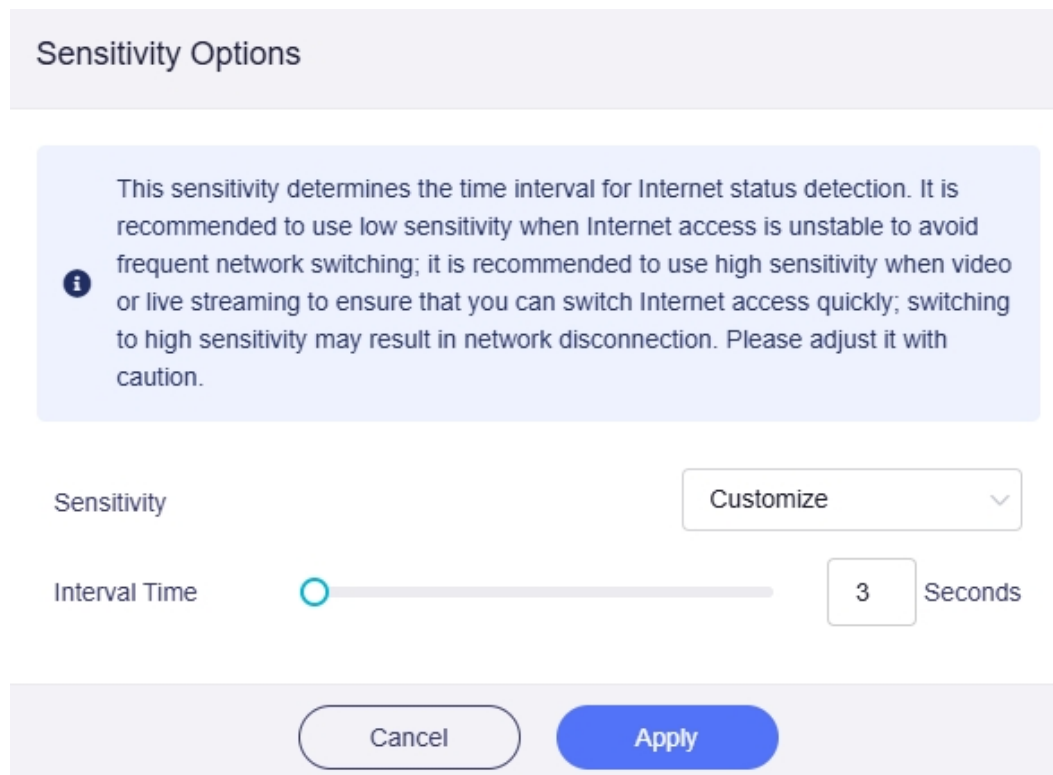

Sensitivity Options

This sensitivity determines the time interval for Internet status detection. It is recommended to use low sensitivity when Internet access is unstable to avoid frequent network switching; it is recommended to use high sensitivity when video or live streaming to ensure that you can switch Internet access quickly; switching to high sensitivity may result in network disconnection. Please adjust it with caution.

Sensitivity Customize

Interval Time 3 Seconds

Cancel Apply

14.2.2 Multi-WAN Mode

Two modes are available for Multi-WAN: **Failover** and **Load Balance**. Note that these modes are mutually exclusive.

Failover

Failover is the default mode when multiple connections are configured. If the active link fails, the router will automatically switch to another network interface for Internet access.

You can set priority levels for each interface: when the currently used interface fails, the router switches to the next available interface with the highest priority. Once a higher-priority connection is restored, the router will automatically switch back to it.





The router supports connections to multiple network interfaces at the same time. You can configure how these multiple networks should be used.

Failover: If the current, active link fails, the router will automatically switch to another network interface.

Load Balance: Uses multiple network interfaces at the same time to increase the total bandwidth of the router. Note that connections to the same application or site will usually only use one interface.

Mode  Failover Load Balance

Interface Priority

1	Ethernet 1	
2	Ethernet 2	
3	Repeater	
4	Tethering	
5	Cellular	

Apply

Load Balance

Load Balance mode uses multiple network interfaces simultaneously to increase the router's total bandwidth, with the system distributing new connections across interfaces according to a configured load ratio. Note that connections to the same application or website will typically use only one interface.

The load ratio refers to the proportion between each network interface. The system will assign interfaces to handle new connections based on this configured ratio. For example, if the router is connected to five networks (e.g., Ethernet 1, Repeater, Tethering, Cellular, and Ethernet 2) simultaneously and all interfaces are available for Internet access, enabling Load Balance and setting a 1:1:1:1:1 ratio means the five interfaces will share network bandwidth equally. The system will distribute new connections across these interfaces according to the configured load ratio.

The router supports connections to multiple network interfaces at the same time. You can configure how these multiple networks should be used.

i Failover: If the current, active link fails, the router will automatically switch to another network interface.

Load Balance: Uses multiple network interfaces at the same time to increase the total bandwidth of the router. Note that connections to the same application or site will usually only use one interface.

Mode **i**

Failover

Load Balance

Load Ratio

Ethernet 1

1



Repeater

1



Tethering

1



Cellular

1



Ethernet 2

1



You can also customize the load ratio as needed. For example, if Ethernet 1 has a bandwidth of 100 Mbps, Repeater has 200 Mbps, and no other connections are active, set the load ratios to 1 for Ethernet 1, 2 for Repeater, and 0 for Tethering, Cellular and Ethernet 2. The system will then distribute new connections across these interfaces according to the configured 1:2 ratio, meaning Ethernet 1 will handle half as many connections as Repeater. Unlike Failover mode, this mode optimizes overall throughput efficiency by balancing traffic load across all available interfaces.

Note: Existing connections or traffic are not guaranteed to align with the load ratio. The actual distribution will gradually approach the configured ratio with prolonged use.

14.3 LAN

LAN (Local Area Network) refers to the private local network, to which your devices connect via Ethernet cables.

Log in to your router's web admin panel and navigate to **NETWORK > LAN**. Here you can configure LAN settings, including basic settings, DHCP server, and address reservation.

14.3.1 Basic Settings

The basic settings include Router IP address and Netmask. You can set subnet within IPv4 private address ranges: 192.168.0.0/16, 172.16.0.0/12, 10.0.0.0/8

LAN

i You can set subnet within IPv4 private address ranges: 192.168.0.0/16, 172.16.0.0/12, 10.0.0.0/8

Router IP Address *i*

Netmask

Apply

- **Router IP Address:** This is the address entered into a browser's address bar to access the router's admin panel. It is 192.168.8.1 by default and can be changed if it conflicts with the upstream network.
- **Netmask:** Two options are available: 255.255.255.0 and 255.255.0.0.

14.3.2 DHCP Server

The DHCP server automatically assigns IP addresses and other communication parameters to each connected client. GL.iNet router's DHCP server is enabled by default, and the DHCP server's IP address pool ranges from 192.168.8.100 to 192.168.8.249. You can customize the address range as needed.

DHCP Server

The DHCP server automatically assigns IP addresses and other communication parameters to client devices. If the DHCP server is disabled, client device network settings will need to be configured manually. [Learn More](#)

Enable

Start IP Address

End IP Address

[Advanced](#)

[Apply](#)

Click **Advanced** in the bottom right corner.

Start IP Address

End IP Address

 [Advanced](#)

[Apply](#)

You will be able to configure advanced settings, including Lease Time, Gateway, DNS Server(s), and LPR Server.

Lease Time	<input type="text" value="720"/>	Minutes
Gateway	<input type="text" value="Optional"/>	
DNS Server 1	<input type="text" value="Optional"/>	
DNS Server 2	<input type="text" value="Optional"/>	
LPR Server 	<input type="text" value="Optional"/>	

[+ Add](#)

- **Lease Time:** The duration for which a device can use an IP address assigned via DHCP.
- **Gateway:** The router component that routes traffic between the local network and external networks (e.g., the internet).
- **DNS Server 1:** The primary server responsible for translating domain names into IP addresses.
- **DNS Server 2:** A backup server used to resolve domain names if the primary DNS server fails.
- **LPR Server:** (Line Printer Remote Server) A service that manages print jobs and enables networked devices to send print requests to remote printers. Multiple LPR ports for printers can be configured.

Note: If DHCP server is disabled, you need to configure static IP and other communication parameters manually for each clients. See [here](#) for details.

14.3.3 Address Reservation

Address reservation allows you to specify a fixed IP address for a LAN client, so that the client will always receive the same IP address each time it accesses the router's DHCP server. You can assign reserved IP addresses to computers or servers that require permanent IP settings. Note that clients with address reservation configured must reconnect to the router to activate the setting.

Follow the steps below to configure address reservation as needed.

1. Log in to your router's web admin panel, navigate to **NETWORK > LAN > Address Reservation**, and click **Add**.
2. In the pop-up window, select the MAC address from the drop-down list, then the corresponding IP address for the selected MAC will be auto-filled. Enter a descriptive name and click **Submit**.

Add a New Reservation Entry

MAC	<input type="text"/>
IP	192.168.8.223
Description	Lauren-iPhone

3. After adding a new IP address reservation, the page will display the reserved entry, as shown below.

Address Reservation

When you specify a reserved IP address for a LAN client, the client will always receive the same IP address when it requests an IP address from router's DHCP server. You can assign reserved IP addresses to computers or servers that require permanent IP settings.
Note: Configured clients have to reconnect the router to activate.

MAC	IP	Description	Action
<input type="text"/>	192.168.8.223	Lauren-iPhone	...

14.4 Guest Network

Guest Network refers to a dedicated network for visitors to connect to, isolating them from your main LAN to protect your private network security.

Log in to your router's web admin panel and go to **NETWORK** -> **Guest Network**. This page allows you to configure Guest Network settings, including basic settings and DHCP server.

14.4.1 Basic Settings

The basic settings include Gateway, Netmask, AP Isolation, and Block WAN Subnets.

Guest Network

i You can set subnet within IPv4 private address ranges: 192.168.0.0/16, 172.16.0.0/12, 10.0.0.0/8

Gateway

Netmask

Security Settings

AP Isolation **i**

Block WAN Subnets **i**

- **Gateway:** It is 192.168.9.1 by default and can be changed as needed, but it must not conflict with the gateway of the main network.
- **Netmask:** Two options are available: 255.255.255.0 and 255.255.0.0.
- **AP Isolation:** It is used to isolate guest network clients into separate segments so they cannot communicate with other devices on the same network.
- **Block WAN Subnets:** If enabled, the guest network will not be able to access the upstream network or its corresponding network segment.

14.4.2 DHCP Server

Since the Guest network is disabled by default, its DHCP server is disabled and hidden until it is manually enabled.

When enabled, the DHCP server automatically assigns IP addresses and other communication parameters to each connected client. The DHCP server's IP address pool for the Guest network ranges from 192.168.9.100 to 192.168.9.249. You can customize the address range as needed.

DHCP Server

i The DHCP server automatically assigns IP addresses and other communication parameters to client devices. If the DHCP server is disabled, client device network settings will need to be configured manually. [Learn More](#)

Enable

Start IP Address

End IP Address

[Advanced](#)

[Apply](#)

Click **Advanced** in the bottom right corner.

Start IP Address

End IP Address

 [Advanced](#)

[Apply](#)

You will be able to configure advanced settings, including Lease Time, Gateway, DNS Server(s), and LPR Server.

Lease Time	<input type="text" value="720"/>	Minutes
Gateway	<input type="text" value="Optional"/>	
DNS Server 1	<input type="text" value="Optional"/>	
DNS Server 2	<input type="text" value="Optional"/>	
LPR Server 	<input type="text" value="Optional"/>	

[+ Add](#)

- **Lease Time:** The duration for which a device can use an IP address assigned via the Guest network's DHCP.
- **Gateway:** The router component that routes traffic between the guest network and external networks (e.g., the internet).
- **DNS Server 1:** The primary server responsible for translating domain names into IP addresses.
- **DNS Server 2:** A backup server used to resolve domain names if the primary DNS server fails.
- **LPR Server:** (Line Printer Remote Server) A service that manages print jobs and enables networked devices to send print requests to remote printers. Multiple LPR ports for printers can be configured.

14.5 DNS

DNS (Domain Name System) is a network service that translates human-readable domain names (e.g., www.google.com) into machine-recognizable IP addresses (e.g., 142.250.185.142), enabling devices to connect to target websites or services.

Router DNS Server refers to the DNS service built into the router, which provides domain name-to-IP translation for all connected devices. It typically works in two ways: first, it automatically obtains DNS addresses from the upstream network to provide default translation services; second, users can manually configure custom public DNS addresses (e.g., 8.8.8.8) on the router's web admin panel to optimize network access or enhance security. Once set up, all connected devices will use this unified DNS server by default, eliminating the need for separate DNS configuration on each device.

Log in to your router's web admin panel and navigate to **NETWORK > DNS**. This page allows you to configure DNS related settings, including security options, server modes, and DNS priority rules for different network scenarios.

The screenshot shows the DNS configuration interface. At the top, there is a header labeled "DNS". Below it is an information box with a blue background and a white border, containing a blue information icon and text: "When you set custom DNS servers, any DNS queries will be resolved through them (instead of the DNS servers obtained through network interface). Otherwise, you will use the DNS settings configured for each interface." Below the information box are three settings, each with a blue information icon and a toggle switch: "DNS Rebinding Attack Protection" (toggle off), "Override DNS Settings of All Clients" (toggle off), and "Allow Custom DNS to Override VPN DNS" (toggle on). Below these settings is a section titled "DNS Server Settings" with a light blue background. Under this section, there is a "Mode" label and a dropdown menu currently set to "Automatic". Below the dropdown is a "DNS from Repeater" label and the IP address "192.168.18.1". At the bottom center of the page is a blue rounded button labeled "Apply".

- **DNS Rebinding Attack Protection:** Protects against DNS rebinding attacks by blocking malicious DNS resolution attempts. Note that enabling it may cause private DNS lookup failure; disable if your network uses a captive portal (e.g., public Wi-Fi login pages).
- **Override DNS Settings of All Clients:** If enabled, all connected devices will be forced to use the DNS servers configured on the router, ignoring their own original DNS settings. It enables unified DNS configuration for all devices.
- **Allow Custom DNS to Override VPN DNS:** When enabled, if you have set custom DNS, packets transmitted through the VPN tunnel will use the custom DNS for resolution, instead of the DNS servers from the VPN connection. This ensures your custom DNS resolution rules apply normally when using VPN.

14.5.1 DNS Server Settings

There are four modes for the DNS server: Automatic, Encrypted DNS, Manual DNS, and DNS Proxy.

The screenshot shows the 'DNS Server Settings' configuration page. The 'Mode' dropdown is set to 'Automatic'. The 'DNS from Repeater' dropdown is also set to 'Automatic', with a menu open showing options: 'Automatic' (highlighted), 'Encrypted DNS', 'Manual DNS', and 'DNS Proxy'. An 'Apply' button is visible below the settings.

1. **Automatic:** When selected, the router will automatically obtain DNS server addresses from the upstream network and apply them to all connected devices.

This screenshot shows the 'DNS Server Settings' page with 'Mode' set to 'Automatic'. The 'DNS from Repeater' field is populated with the IP address '192.168.18.1'.

2. **Encrypted DNS:** When selected, the router will use encrypted protocols to process DNS queries, securing resolution data against eavesdropping or tampering.

It has four encryption type: DNS over TLS, DNSCrypt-Proxy, DNS over HTTPS, and Oblivious DNS over HTTPS.

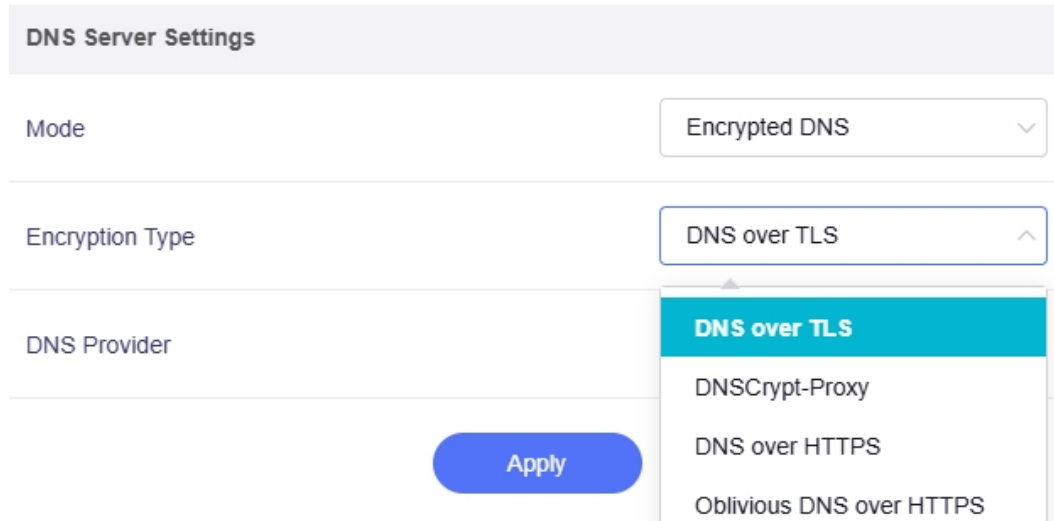

The screenshot shows the 'DNS Server Settings' interface. The 'Mode' is set to 'Encrypted DNS'. The 'Encryption Type' dropdown menu is open, showing four options: 'DNS over TLS' (highlighted in blue), 'DNSCrypt-Proxy', 'DNS over HTTPS', and 'Oblivious DNS over HTTPS'. A blue 'Apply' button is visible below the settings.

- For DNS over TLS, select a DNS provider among Control D, NextDNS, and Cloudflare.
 - For the other three (i.e., DNSCrypt-Proxy, DNS over HTTPS, and Oblivious DNS over HTTPS), select at least one DNS server from the repository. Up to 8 servers can be selected. When multiple servers are selected, the router will use the fastest one automatically.
3. **Manual DNS:** When selected, you can customize your router's DNS servers. Click DNS Server 1 and choose a DNS server from the drop-down list. The remaining DNS fields will update automatically.

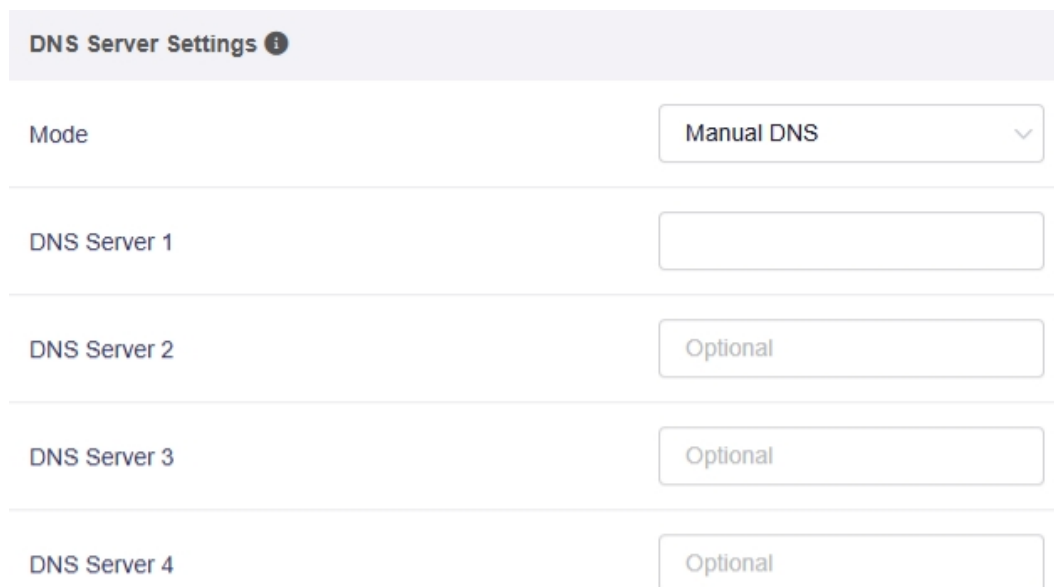

The screenshot shows the 'DNS Server Settings' interface with 'Manual DNS' selected in the 'Mode' dropdown. The 'DNS Server 1' field is empty. The 'DNS Server 2', 'DNS Server 3', and 'DNS Server 4' fields are all set to 'Optional'.

Note: If you need to use IPv6 addresses for manual DNS, enable IPv6 on your router first.

4. **DNS Proxy:** When selected, the router forwards all DNS queries through a proxy server, allowing resolution via the proxy's network environment for specific access needs.

DNS Server Settings ⓘ

Mode DNS Proxy ▾

Proxy Server Address 8.8.8.8#53

14.5.2 Edit Hosts

You can define static DNS resolution rules as needed.

On the DNS page, click **Edit Hosts** in the top right corner.

DNS → [Edit Hosts](#)

ⓘ When you set custom DNS servers, any DNS queries will be resolved through them (instead of the DNS servers obtained through network interface). Otherwise, you will use the DNS settings configured for each interface.

DNS Rebinding Attack Protection ⓘ

Override DNS Settings of All Clients ⓘ

Allow Custom DNS to Override VPN DNS ⓘ

DNS Server Settings

Mode Automatic ▾

DNS from Repeater 192.168.18.1

[Apply](#)

Requests from clients will be resolved preferentially using the static DNS rules written here, allowing you to manually map IP addresses to hostnames (e.g., the default entries like 127.0.0.1 localhost for local loopback) for customized domain name resolution control.

Edit Hosts

i Requests from clients will be resolved, initially, using the static DNS rules you have written in Hosts.

```
1 127.0.0.1 localhost
2
3 ::1 localhost ip6-localhost ip6-loopback
4 ff02::1 ip6-allnodes
5 ff02::2 ip6-allrouters
6
```

Cancel

Apply

14.6 Ethernet Port

Log in to your router's web admin panel and navigate to **NETWORK > Ethernet Port**. This page allows you to manage the router's Ethernet ports.

The **WAN** section displays the port role (WAN or LAN), MAC address, and negotiated rate.

The screenshot shows the WAN configuration interface. At the top, there are two tabs: 'WAN' (selected) and 'LAN'. Below the tabs, there is a 'WAN/LAN' dropdown menu set to 'Ethernet1'. To the right of this menu are two buttons: 'WAN' (highlighted in blue) and 'LAN'. Below this is a 'MAC Mode' dropdown menu set to 'Factory'. Underneath, the 'MAC Address' is displayed as '94:83:C4:BE:E1:22'. A section titled 'Negotiated Network Port Rate' contains a 'Speed' field showing '2500 Mbps full duplex'. At the bottom, there is a blue 'Apply' button.

The **LAN** section allows you to switch LAN to WAN. You can switch the port role and check the negotiated rate here.

The screenshot shows the LAN configuration interface. At the top, there are two tabs: 'WAN' and 'LAN' (selected). Below the tabs, there is a 'WAN/LAN' dropdown menu. To the right of this menu are two buttons: 'WAN' and 'LAN' (highlighted in blue). Below this is a section titled 'Negotiated Network Port Rate' containing a 'Speed' field showing '2500 Mbps full duplex'. At the bottom, there is a blue 'Apply' button.

Note: The negotiated rate for WAN and LAN ports is displayed only when an Ethernet cable is connected. It depends on both the Ethernet port and the Ethernet cable.

14.7 Network Mode

Network mode refers to the different operational roles and functions a router can assume to meet various network deployment needs.

Log in to your router's web admin panel and navigate to **NETWORK > Network Mode**. You can change the network mode of your router.

Network Mode

 When you change the router's network mode, you may need to reconnect all of your client devices.
When you use Access Point / WDS, you will not be able to connect to this UI again. You can press and hold the reset button for 4 seconds to revert to router mode. [Learn More](#)

Router
Create your own private network. The router will act as NAT, firewall and DHCP server.

Access Point
Connect to a wired network and broadcast a wireless network.

Extender
Extend the Wi-Fi coverage of an existing wireless network.

WDS
Similar to Extender, please choose WDS if your main router supports WDS mode.

- **Router:** This is the default operational mode for most home and small office routers, designed to create a private local area network (LAN) and act as a dedicated gateway between the public internet and connected devices. In this mode, the router enables core functions including NAT, DHCP, and a built-in firewall. It connects to an upstream line such as broadband fiber, automatically assigns private IP addresses to connected devices, and provides network security for the entire private network.
- **Access Point:** This mode enables a router to connect to a wired network via a LAN cable and broadcast wireless signals, expanding Wi-Fi coverage in large spaces to allow more

devices to access the network. In this mode, the router disables its NAT and DHCP functions, operating purely as a wireless signal transmitter and switch rather than a standalone gateway.

- **Extender:** This mode is designed to extend the Wi-Fi coverage of an existing wireless network and eliminate signal dead zones in areas with poor connectivity. It enables the router to wirelessly receive signals from the main router, amplify them, and retransmit the boosted signal. Unlike Access Point mode, it requires no wired connection to the main router, but it may lead to bandwidth halving, as the device has to handle simultaneous signal reception and transmission.
- **WDS:** Wireless Distribution System (WDS) mode is similar to Extender mode as it extends Wi-Fi coverage wirelessly, but it supports wireless bridging between multiple compatible routers. It is recommended for wireless network expansion when the upstream router has WDS functionality.

This mode is ideal for scenarios like covering multi-story buildings or small office campuses where multiple routers need to work together to form a unified wireless network. Unlike Extender mode, which only transmits signals from one main router to a single extender, WDS mode allows interconnected routers to both send and receive signals, enabling seamless coverage across larger areas with multiple signal nodes.

Note:

1. When the network mode is changed, all client devices shall reconnect to the router for stable network connectivity.
2. **In Access Point / WDS mode, you will not be able to access the web admin panel using the original IP address.** Instead, you need to log in to the upstream router to find the IP address it has assigned to this router, then use this IP address to access the web admin panel. If you do not have access to the upstream router, press and hold the reset button for 4 seconds to revert it to the default Router mode.
3. **In Access Point / Extender / WDS mode, the following features will be unavailable:** Access Control (Allowlist and Blocklist), AstroWarp, VPN, AdGuard Home, Parental Control, ZeroTier, Tailscale, Port Forwarding, Multi-WAN, DHCP Server, Address Reservation, Guest Network, DNS, Ethernet Port, IPv6, Drop-in Gateway, IGMP Snooping, Network Acceleration, NAT Settings.

14.8 IPv6

IPv6 (Internet Protocol version 6) is the latest Internet Protocol designed to replace IPv4. It offers a larger pool of unique IPs, solving the address exhaustion issue of IPv4 and supporting the growing number of connected devices globally.

Log in to your router's web admin panel and navigate to **NETWORK > IPv6**. This page allows you to enable and configure IPv6 on your router. When IPv6 is enabled, WAN interfaces such as Ethernet will get their IPv6 addresses via DHCPv6.

Toggle on **Enable**, select the mode for your main network and DNS acquisition method, then click **Apply**.

IPv6

i When IPv6 is enabled, WAN interfaces such as Ethernet will get their IPv6 addresses via DHCPv6. You can also modify the IPv6 address manually in the Ethernet settings page. Some features (Port Forwarding, GoodCloud, OpenVPN DCO) do not yet support IPv6.

Enable

LAN

Mode

DNS acquisition method

Apply

Note: Some features (e.g., firewall, GoodCloud, OpenVPN DCO) do not yet support IPv6. If you enable these features and IPv6 at the same time, it's likely to cause connectivity issues.

14.8.1 IPv6 Mode

Four modes are available: Native, Passthrough, NAT6 and Static IPv6.

- **Native:** This mode is applicable when the router directly obtains a public IPv6 address, and the router automatically assigns IPv6 addresses to online devices. This mode can meet the IPv6 access needs of most users.
- **Passthrough:** This mode is applicable when IPv6 packets need to be directly passed through without any processing or conversion. For example, some specific applications or services may require the complete preservation of IPv6 packet content for further processing or analysis. This mode is used by technical personnel for network debugging or security analysis.
- **NAT6:** This mode is suitable for scenarios where a router is used as a gateway to assign dynamic internal IPv6 addresses to each device on the network. In this mode, terminal devices connect through a Optical Network Terminal and obtain a local area network IPv6 address.
- **Static IPv6:** This mode is suitable for devices or services that require a fixed IPv6 address, such as servers or network printers. This mode ensures that the device always uses the same IPv6 address, facilitating management and access.

14.8.2 DNS acquisition method

It determines how the router obtains IPv6 DNS server addresses. There are two options: Automatic and Manual.

- **Automatic:** The router will obtain IPv6 DNS server addresses dynamically (e.g., via DHCPv6).
- **Manual:** Input custom IPv6 DNS server addresses. However, since DNS is used to resolve domain names to their corresponding IP addresses, manual DNS server configuration may result in DNS lookup failures. Please use it with caution.

14.9 Drop-in Gateway

Drop-in Gateway is an extension function that enables capability expansion for an existing primary router without replacing or re-configuring it. By connecting the GL.iNet router to the primary router via an Ethernet cable, users can add advanced features onto the existing network infrastructure, for example:

- Filter advertisements via AdGuard Home
- Enable VPN client
- Use encrypted DNS

Drop-in Gateway operates as an intermediate network system, routing data traffic from client devices through the GL.iNet router for processing before transmitting it via the primary router. During this process, it not only preserves existing network settings to ensure uninterrupted connectivity for all connected devices, but also allows you to manage network traffic for all or specific client devices as needed.

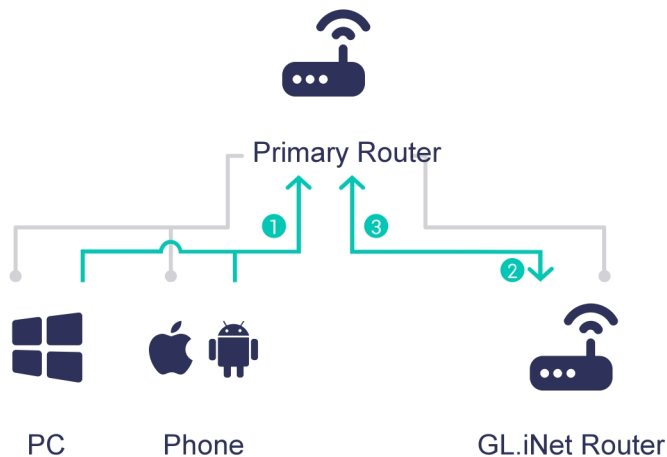

The diagram above consists of two types of lines: gray lines, and green lines marked with three arrows, each labeled with a corresponding number.

- **Gray lines** illustrate the physical connection topology: client devices (e.g., computer, laptop) connect to the primary router, and the primary router's LAN port links to the WAN port of the GL.iNet router (with Drop-in Gateway enabled) via an Ethernet cable.

- **Green lines** depict the sequential data transmission path when Drop-in Gateway is active, with the numbered arrows indicating the traffic flow order:
 1. Traffic from client devices is first routed to the primary router;
 2. The primary router forwards the traffic to the GL.iNet router for processing (e.g., ad filtering, VPN encryption);
 3. After processing, the traffic is sent back to the primary router, which then either delivers the final data to the original client devices or routes it out to the Internet.

You can enable Drop-in Gateway for all or specific devices connected to your primary router. See [this link](#) for more details.

14.10 IGMP Snooping

IGMP Snooping listens to the IGMP protocol package, extracts the corresponding information, establishes and maintains the layer 2 multicast forwarding table, and then forwards the multicast group data to the host that joins the multicast group, while other hosts cannot receive the multicast group data.

Log in to your router's web admin panel and navigate to **NETWORK > IGMP Snooping**. You can enable it to use the multicast function on your router as needed.

IGMP Snooping

 IGMP Snooping listens and extracts information from the IGMP protocol package, establishes and maintains the layer 2 multicast forwarding publication, and then forwards the multicast group data to any host that joins the multicast group, whilst other hosts cannot receive the multicast group data.

IGMPv3 is compatible with v1 and v2. Use v3 by default, and switch if you experience a problem.

Enable



Version

3

Apply

14.11 Network Acceleration

Network acceleration reduces CPU load and speeds up traffic packet forwarding, but can conflict with some features.

Log in to your router's web admin panel, and navigate to **NETWORK > Network Acceleration**. This page allows you to enable network acceleration and select acceleration mode among Auto, Hardware Acceleration and Software Acceleration.

Network Acceleration

Network acceleration reduces CPU load and speeds up traffic packet forwarding, but can conflict with some features.

- When Network acceleration is enabled, the following functions will not work properly: Client Speed and Traffic Statistics, Client Speed Limit, Parental Control, VPN with IPv6.

Enable



Mode

Auto

Apply

- **Auto:** Automatically switch between the two acceleration modes based on actual usage.
- **Hardware Acceleration:** It offloads high-frequency network tasks (e.g., NAT, packet forwarding, checksum verification) to dedicated hardware like NPUs or HWNAT chips. It specifically works on Ethernet and Repeater connections, excelling in these scenarios with fixed paths and simple rules to deliver high throughput, low latency, and minimal CPU load for wire-speed data transmission.
- **Software Acceleration:** It relies on a router's general CPU paired with optimized kernels or drivers (e.g., SWNAT). It works on Cellular (4G/5G) access, typically the primary scenario where hardware acceleration is unavailable, offering strong compatibility and support for complex protocols. While flexible, it may hit CPU bottlenecks under high bandwidth loads, especially when running advanced features.

Note: When Network acceleration is enabled, the following functions will not work properly: Client Speed Statistics, Traffic Statistics, Speed Limit, Parental Control, and VPN with IPv6.

14.12 NAT Settings

Log in to your router's web admin panel and navigate to **NETWORK > NAT Settings**. This page allows you to configure two key NAT-related features: Full Cone NAT and SIP ALG.

NAT Settings

Enable Full Cone NAT ⓘ

Enable SIP ALG ⓘ

Apply

- **Full Cone NAT:** It can be used to reduce game latency, enhancing the responsiveness of online gaming. However, enabling Full Cone NAT may be less secure as it allows unrestricted incoming connections.
- **SIP ALG:** It is intended to mitigate the effects of multiple NATs on SIP (Session Initiation Protocol) traffic. However, in most cases, it will not help and may even affect VoIP calls, causing issues like one-way audio, phones not ringing, unexpected call drops, or calls going directly to voicemail.

Chapter 15

System

This chapter covers system management tools for the device, such as system overview, upgrade, scheduled tasks, time zone, log, firmware reset, and advanced settings.

15.1 Overview

Log in to your router's web admin panel and navigate to **SYSTEM > Overview**. This page displays hardware status and supports some simple controls, including:

- CPU, Memory, and Flash Status
- LED Control
- Device Information
- External Storage Protocol Switch

Overview

CPU Average Load 4 Cores

70 °C
CPU Temperature

0 RPM
Fan

Memory Usage

LED

Enable LED

The LED time has not been set.

Flash

System Used	32.12%(164.43 MB)
Apps Used	1.39%(7.12 MB)
Available	66.49%(340.45 MB)

Device Info

Mon, May 11, 2026 12:30 PM (UTC+08:00)

Up Time **0 : 2 : 41**
Days Hours Minutes

Hostname	GL-MT3600BE
Model	GL.iNet GL-MT3600BE
Architecture	ARMv8 Processor rev 4
OpenWrt Version	OpenWrt 21.02-SNAPSHOT

External Storage

This feature supports USB 2.0 and USB 3.0 protocol switching.

USB Protocol Switch USB2.0 **USB3.0**

15.2 Upgrade

Log in to your router's web admin panel and navigate to **SYSTEM > Upgrade**. You can upgrade the router's firmware version by online upgrade or local upgrade.

15.2.1 Online Upgrade

You can find the current firmware details here, including firmware version, firmware type (e.g., release, beta), and update time.

Upgrade

Firmware Online Upgrade Firmware Local Upgrade

✓ Firmware is up-to-date.

Current Firmware

Version	4.8.3
Firmware Type	release1
Update Time	2026-04-13 07:14:36 (UTC+00:00)

Preview Version

Accept Preview Plan 

- **Accept Preview Plan:** If this option is enabled, you can try new features before the final version is issued and provide us with feedback. Set it once and it stays on. Note that these upgrades may not be stable.

If your router is connected to the Internet, it will check for the newer firmware version available for download.

Tip: When trying to perform an online upgrade, if it displays **Download Failed**, please navigate to **SYSTEM -> Time Zone**, and fix the time zone error (sync to browser).

15.2.2 Local Upgrade

Local upgrade does not rely on an Internet connection for the router.

Download the correct firmware package (matching your router model) from the official [Download Center](#) to your local device. Then log in to the router's web admin panel, navigate to **SYSTEM > Upgrade > Local Upgrade** section, and upload the firmware package.

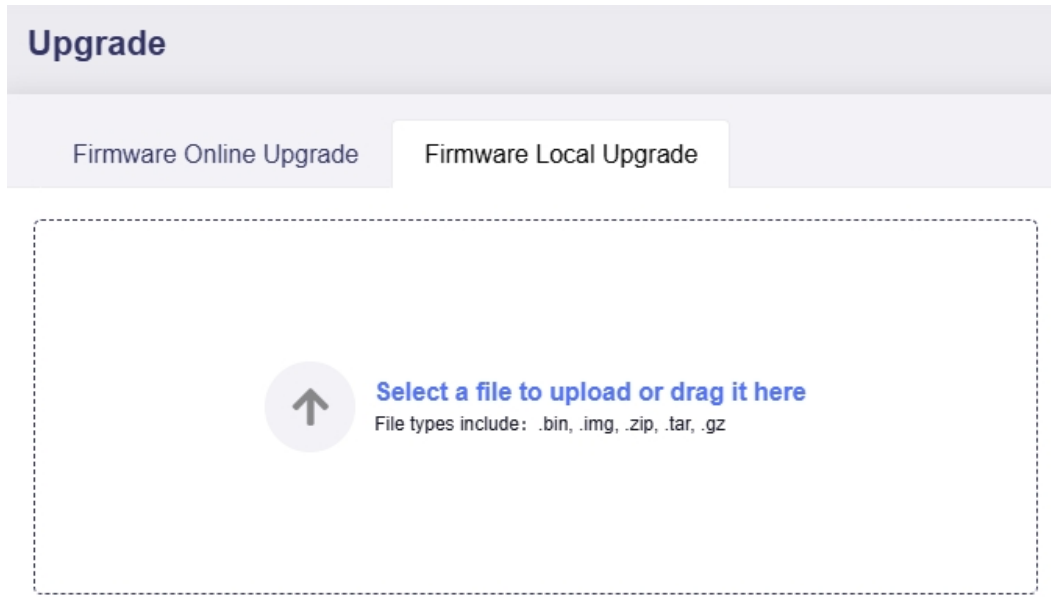

The page will display the firmware details. Verify these details before clicking **Install**.

Firmware Verification	
Version	4.8.1 Release Notes
Firmware Type	release8
SHA256	ee038ee0f399c1454cc660dd47811b44697f5304e0f61af145c7dca6817d0e5c
Verification Result	Pass
Keep Settings i	<input checked="" type="checkbox"/>

[Install](#)

- **Keep Settings:** If enabled, current settings are retained. However, any manually installed packages must be reinstalled after the upgrade completes. Do not enable this option when downgrading the firmware.

15.3 Scheduled Tasks

Log in to your router's web admin panel and navigate to **SYSTEM > Scheduled Tasks**. This page allows you to set up a daily schedule for some basic actions, including switching LED light on and off, and restarting the router.

Note: Please synchronize the time in the [Time Zone](#) before using this function. If the device is shut down at the scheduled time, the task will not be executed.

15.3.1 LED Display Schedule

Set a schedule for your router's LED light as needed.

LED Display Schedule

Enable Scheduled

Turn On Time

Turn Off Time

day(s) Su Mo Tu We Th Fr Sa

- **Enable Scheduled:** Toggle this switch to enable the LED display schedule.
- **Turn On Time:** Set the time (e.g., 07:00) when the LED light will turn on.
- **Turn Off Time:** Set the time (e.g., 22:00) when the LED light will turn off.
- **day(s):** Select the effective days of the week for these settings.

After configuring, click **Apply** to save your settings.

15.3.2 Schedule Reboot

Set a schedule for automatically restarting your router as needed.

Schedule Reboot

Enable Scheduled

Reboot Time

day(s) Su Mo Tu We Th Fr Sa

- **Enable Scheduled:** Toggle this switch to enable the scheduled reboot.
- **Reboot Time:** Set the specific time (e.g., 03:00) when the router will restart.
- **day(s):** Select the effective days of the week for these settings.

After configuring, click **Apply** to save your settings.

15.3.3 MLO Wi-Fi Schedule

This function allows you to set a schedule for your MLO Wi-Fi. You can enable the on/off schedule for both the MLO Main Wi-Fi and Guest Wi-Fi.

MLO Wi-Fi Status Schedule

Wi-Fi Scheduled Mode

Enable Main Wi-Fi Schedule

Enable Guest Wi-Fi Schedule

- **Main Wi-Fi Schedule:** When enabled, set the on and off times for your MLO Main Wi-Fi, and select an effective date for the week.

Enable Main Wi-Fi Schedule

Main Wi-Fi

Turn On Time

Turn Off Time

day(s) Su Mo Tu We Th Fr Sa

- **Guest Wi-Fi Schedule:** When enabled, set the on and off times for your MLO Guest Wi-Fi, and select an effective date for the week.

Enable Guest Wi-Fi Schedule

Guest Wi-Fi

Turn On Time

Turn Off Time

day(s) Su Mo Tu We Th Fr Sa

After configuring, click **Apply** to save your settings.

15.3.4 5GHz Wi-Fi Schedule

This function allows you to set a schedule for your 5GHz Wi-Fi. There are two modes: Turn On/Off, and Switch TX Power.

Mode 1: Turn On/Off

You can enable the on/off schedule for both the 5GHz Main Wi-Fi and Guest Wi-Fi.

5 GHz Wi-Fi Status Schedule

Wi-Fi Scheduled Mode

Turn On/Off

Enable Main Wi-Fi Schedule



Enable Guest Wi-Fi Schedule



- **Main Wi-Fi Schedule:** When enabled, set the on and off times for your 5GHz Main Wi-Fi, and select an effective date for the week.

Enable Main Wi-Fi Schedule



Main Wi-Fi

Turn On Time

07:00

Turn Off Time

22:00

day(s)

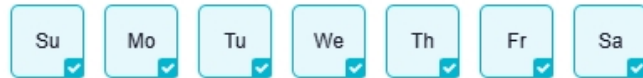

- **Guest Wi-Fi Schedule:** When enabled, set the on and off times for your 5GHz Guest Wi-Fi, and select an effective date for the week.

Enable Guest Wi-Fi Schedule



Guest Wi-Fi

Turn On Time

07:00

Turn Off Time

22:00

day(s)

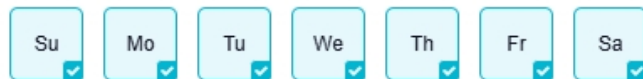

After configuring, click **Apply** to save your settings.

Mode 2: Switch TX Power

You can enable the TX power switching schedule for the 5GHz Main Wi-Fi.

5 GHz Wi-Fi Status Schedule

Wi-Fi Scheduled Mode Switch TX Power

Enable Main Wi-Fi Schedule

When enabled, set two timed actions for your 5GHz Main Wi-Fi to switch TX power, and select an effective date for the week.

Enable Main Wi-Fi Schedule

Main Wi-Fi

Switch 🕒 22:00 Set to Low

Restore 🕒 07:00 Set to Max

day(s) Su Mo Tu We Th Fr Sa

- **Switch:** Set TX Power to a certain level (e.g., Low) at a specific time (e.g., 22:00).
- **Restore:** Restore TX Power to another level (e.g., Max) at another time (e.g., 07:00).
- **days:** Select the effective days of the week for these settings.

After configuring, click **Apply** to save your settings.

15.3.5 2.4GHz Wi-Fi Schedule

This function allows you to set a schedule for your 2.4GHz Wi-Fi. There are two modes: Turn On/Off, and Switch TX Power.

Mode 1: Turn On/Off

You can enable the on/off schedule for both the 2.4GHz Main Wi-Fi and Guest Wi-Fi.

2.4 GHz Wi-Fi Status Schedule

Wi-Fi Scheduled Mode

Turn On/Off

Enable Main Wi-Fi Schedule



Enable Guest Wi-Fi Schedule



- **Main Wi-Fi Schedule:** When enabled, set the on and off times for your 2.4GHz Main Wi-Fi, and select an effective date for the week.

Enable Main Wi-Fi Schedule



Main Wi-Fi

Turn On Time

07:00

Turn Off Time

22:00

day(s)

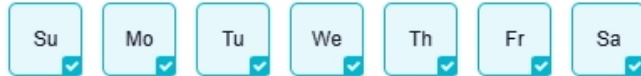

- **Guest Wi-Fi Schedule:** When enabled, set the on and off times for your 2.4GHz Guest Wi-Fi, and select an effective date for the week.

Enable Guest Wi-Fi Schedule



Guest Wi-Fi

Turn On Time

07:00

Turn Off Time

22:00

day(s)

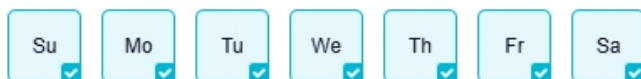

After configuring, click **Apply** to save your settings.

Mode 2: Switch TX Power

You can enable the TX power switching schedule for the 2.4GHz Main Wi-Fi.

2.4 GHz Wi-Fi Status Schedule

Wi-Fi Scheduled Mode

Switch TX Power

Enable Main Wi-Fi Schedule



When enabled, set two timed actions for your 2.4GHz Main Wi-Fi to switch TX power, and select an effective date for the week.

Enable Main Wi-Fi Schedule



Main Wi-Fi

Switch

22:00

Set to

Low

Restore

07:00

Set to

Max

day(s)

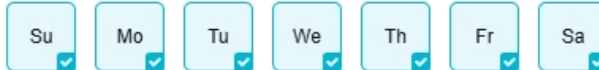

- **Switch:** Set TX Power to a certain level (e.g., Low) at a specific time (e.g., 22:00).
- **Restore:** Restore TX Power to another level (e.g., Max) at another time (e.g., 07:00).
- **days:** Select the effective days of the week for these settings.

After configuring, click **Apply** to save your settings.

15.4 Time Zone

Log in to your router's web admin panel and navigate to **SYSTEM > Time Zone**. This page displays your router's system time, indicating the date, time, and corresponding time zone offset.

Time Zone

Router Time Wed, Nov 5, 2025 7:19 PM (UTC+08:00)

Etc/GMT-8

Apply

Some functions rely on the router's system time to take effect. Therefore, please ensure the correct time zone is properly synchronized. If the router's time zone is different from that of your browser, a prompt will be displayed as follows. Click the **Sync** button to synchronize the time zone.

 The time zone of the router is different from that of your browser. Sync

Router Time Sun, Dec 15, 2024 3:20 PM (UTC+00:00)

UTC

To switch time zone, select the appropriate time zone from the list to ensure the router's system time matches your local time.

Router Time Wed, Nov 5, 2025 7:19 PM (UTC+08:00)

Etc/GMT-8

- Etc/GMT-7
- Etc/GMT-8**
- Etc/GMT-9
- Etc/GMT-10

15.5 Toggle Button Settings

Log in to your router's web admin panel and navigate to **SYSTEM -> Toggle Button Settings**. This page allows you to customize the function of the router's physical toggle switch (located on the side) for easier use. Note that the toggle switch is only available on travel routers and mini routers.

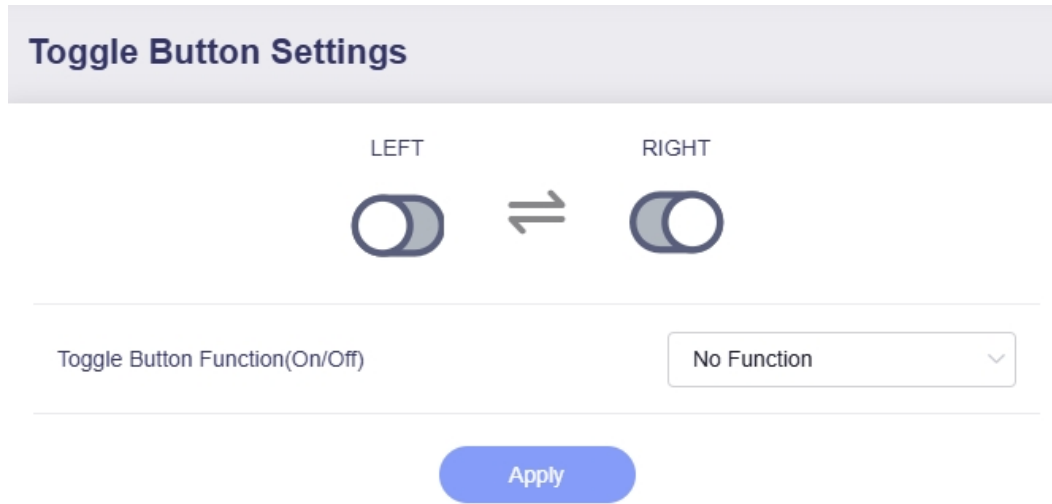

By default, the toggle switch is not assigned any functions. You can customize it as needed to turn specific functions on or off with a single flip.

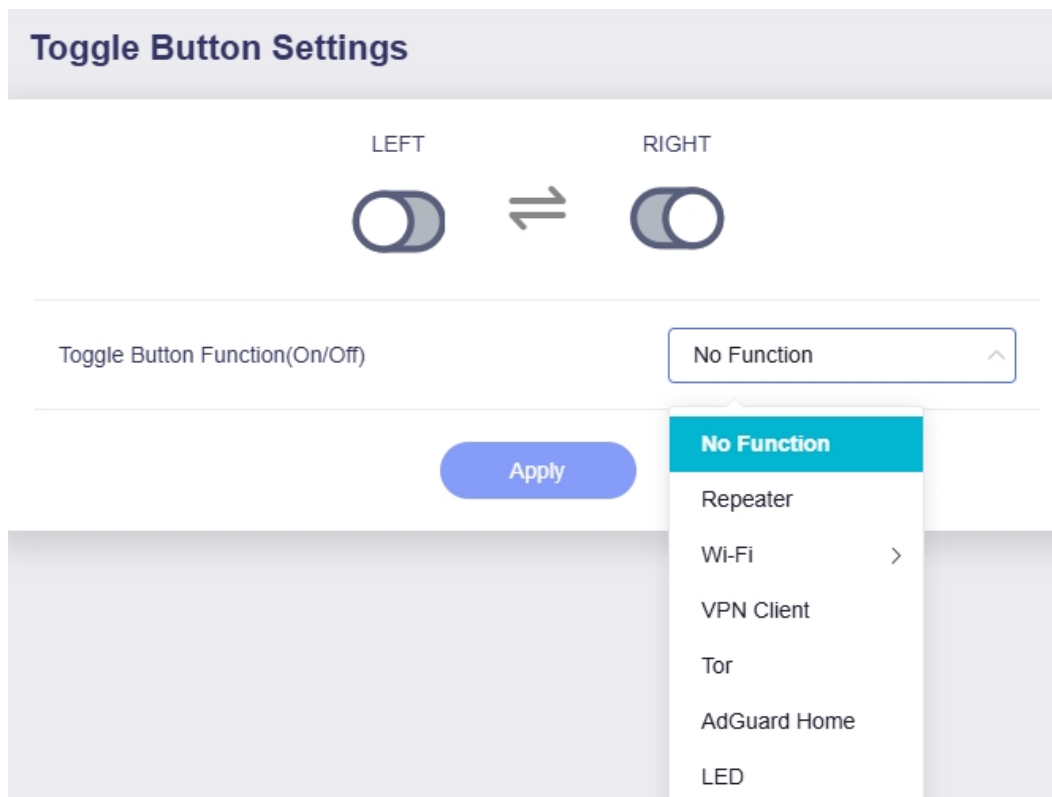

15.6 Log

Log in to your router's web admin panel and navigate to **SYSTEM > Log**. This page allows you to view logs of System, Kernel, Crash, Cloud and Nginx for analysis and troubleshooting. In addition, some cellular models that supports eSIM also provides eSIM log.

Log Export Log Contact Support

System Log Kernel Log Crash Log Cloud Log Nginx Log

Level Module Key word Search Refresh

```
Wed Nov 5 18:17:02 2025 daemon.info dnsmasq[14269]: DNS service limited to local subnets
Wed Nov 5 18:17:02 2025 daemon.info dnsmasq[14269]: compile time options: IPv6 GNU-getopt no-DBus UBus no-i18n no-IDN DHCP DHCPv6 no-Lua
TFTP contrack ipset auth cryptohash DNSSEC no-ID loop-detect inotify dumpfile
Wed Nov 5 18:17:02 2025 daemon.info dnsmasq[14269]: UBus support enabled: connected to system bus
Wed Nov 5 18:17:02 2025 daemon.info dnsmasq-dhcp[14269]: DHCP, IP range 192.168.3.100 -- 192.168.3.200, lease time 30m
Wed Nov 5 18:17:02 2025 daemon.info dnsmasq-dhcp[14269]: IPv6 router advertisement enabled
Wed Nov 5 18:17:02 2025 daemon.info dnsmasq[14269]: using only locally-known addresses for domain test
Wed Nov 5 18:17:02 2025 daemon.info dnsmasq[14269]: using only locally-known addresses for domain onion
Wed Nov 5 18:17:02 2025 daemon.info dnsmasq[14269]: using only locally-known addresses for domain localhost
Wed Nov 5 18:17:02 2025 daemon.info dnsmasq[14269]: using only locally-known addresses for domain local
Wed Nov 5 18:17:02 2025 daemon.info dnsmasq[14269]: using only locally-known addresses for domain invalid
Wed Nov 5 18:17:02 2025 daemon.info dnsmasq[14269]: using only locally-known addresses for domain bind
Wed Nov 5 18:17:02 2025 daemon.info dnsmasq[14269]: using nameserver 2001:4860:4860::8844#53
Wed Nov 5 18:17:02 2025 daemon.info dnsmasq[14269]: using nameserver 2001:4860:4860::8888#53
Wed Nov 5 18:17:02 2025 daemon.info dnsmasq[14269]: using nameserver 8.8.4.4#53
```

- **Search:** The system log page provides filtering for quick search. You can select the log level (e.g., all, info, error) or module (e.g., IPv6, Tethering, Cellular) from the drop-down list, or enter keywords to quickly query logs.
- **Refresh:** Click this button to refresh logs.
- **Export Log:** Click this button to export debug info along with the logs.
- **Contact Support:** Click this button, fill in detailed information in the pop-up window on the right, then click **Send**. Your feedback will be sent directly to GL.iNet Technical Support.

Your Feedback

Subject

Your Contact Email

Description

0/1000

Upload Picture (Optional)



You can upload up to 5 pictures in JPEG or PNG format, all of which must not exceed 10MB in size.

- Upload System Log
- Upload Debug Info
- I have read and agree [Privacy Policy](#)

Cancel

Send

15.7 Security

Log in to your router's web admin panel and navigate to **SYSTEM > Security**. This page contains configuration options for the router's local and remote management, including:

- Admin password
- Local access for web admin panel, LuCI, and SSH
- Remote HTTPS/SSH access
- Router open ports management

15.7.1 Admin Password

In this section, you can change the login password of the web admin panel.

Admin Password

Old Password	<input type="password" value="Enter old password"/>	<input type="checkbox"/>
New Password	<input type="password" value="Enter new password"/>	<input type="checkbox"/>
Confirm Password	<input type="password" value="Enter new password again"/>	<input type="checkbox"/>

The requirements for the admin password are as follows:

1. Minimum 10 characters and maximum 63 characters in length.
2. Letters (case sensitive), numbers and symbols (e.g., ! @ # \$ % ^ & * () _ + - = , . > < | ? / \ [] { } : ; " ' ` ~) are allowed.
3. At least two types (uppercase letters, lowercase letters, numbers, and symbols) are required.

15.7.2 Access Control

This section manages access to the router's multiple interfaces (Admin Panel, LuCI, and SSH). It can prevent scanning and intrusion attempts on the default port and avoid network problems caused by port conflicts.

Access Control

Admin Panel

HTTP Port

HTTPS Port

Force HTTPS

Auto-Logout Time ⓘ Minutes

LuCI

HTTP Port

HTTPS Port

Force HTTPS

SSH

Enable SSH

SSH Port

Admin Panel

- **HTTP Port:** Defaults to 80, used for unencrypted HTTP access to the web admin panel.
- **HTTPS Port:** Defaults to 443, used for secure HTTPS access to the web admin panel.
- **Force HTTPS:** When enabled, access to the web admin panel is enforced to use a secure HTTPS connection.

- **Auto-Logout Time:** Set to 5 minutes by default, it automatically logs out idle admin sessions after this duration for security. You can customize the auto-logout time, ranging from 1 minute to 3 hours.

LuCI

Note: Please install LuCI on the [Advanced Settings](#) before setting the access control for it.

- **HTTP Port:** Defaults to 8080, for unencrypted HTTP access to the LuCI interface.
- **HTTPS Port:** Defaults to 8443, for secure HTTPS access to the LuCI interface.
- **Force HTTPS:** When enabled, access to the LuCI interface is enforced to use a secure HTTPS connection.

SSH

- **Enable SSH:** Enabled by default, it controls whether the SSH access to the router is permitted.
- **SSH Port:** Defaults to 22, the port used for SSH access to the router.

Note:

1. If you assign a port number that conflicts with a reserved port (or one reserved for specific services by browsers/network conventions), a prompt will appear stating "This port is forbidden by the browser".

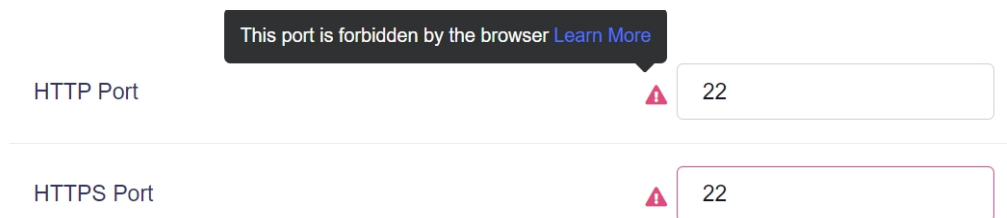

The screenshot shows a configuration interface for LuCI. It has two input fields: "HTTP Port" and "HTTPS Port". Both fields contain the value "22". To the right of each field is a red warning triangle icon. A dark tooltip box is positioned above the "HTTP Port" field, containing the text "This port is forbidden by the browser" followed by a blue link "Learn More".

2. If the port number is modified in the firmware, you need to enter the correct port number to access the admin panel. If you forgot the port number, please reset the router to restore the default port number.
3. LuCI access settings are available only after LuCI is installed. If these settings are not visible, go to **SYSTEM > Advanced Settings** to install LuCI.

15.7.3 Remote Access Control

This section manages remote access to router interfaces, including HTTPS, SSH and WAN-side ping. It also allows you to restrict access from specific IP addresses, striking a balance between remote accessibility and network security.

Remote Access Control

Allow Ping from WAN	<input type="checkbox"/>
HTTPS Remote Access	<input checked="" type="checkbox"/>
SSH Remote Access	<input type="checkbox"/>
Allow Remote Access only from Specific IPs ?	<input type="checkbox"/>

[Apply](#)

- **Allow Ping from WAN:** Allowing Ping from the router's WAN side can help users check whether the router is reachable over the WAN when there is a network issue, as well as determine network latency and packet loss.
- **HTTPS Remote Access:** HTTPS Remote Access enables secure remote access to the router's web admin panel via the HTTPS protocol. It ensures encrypted data transmission when managing the router remotely through a web browser.
- **SSH Remote Access:** SSH Remote Access enables secure access to the router terminal. It allows users to remotely manage the router via SSH, establishing an encrypted tunnel for tasks.
- **Allow Remote Access from Specific IPs:** This feature is only available when any of the above three features are enabled. You can add multiple specified IP addresses to remotely manage the router only from devices with these IPs.

Allow Remote Access only from Specific IPs ?

IP Address List

[+ Add an IP Address](#)

192.168.8.1 example	...
------------------------	-----

15.7.4 Open Ports on Router

This section manages port forwarding for services on your router. Some services, such as web and FTP, require their respective ports to be opened on the router in order to be publicly reachable from the WAN network. For security reasons, services installed on the device are only accessible within the LAN by default. If you need to enable such WAN access, you can open specific ports here.

Open Ports on Router

 For security reasons, the services that you install on the device are only opened to its LAN network. If you want them to be accessible from the WAN network, you need to open ports for these services on the WAN.

[+ Add](#)

To open a port, click **Add**, and enter the required information in the pop-up window.

Add New Open Port

Protocol	<input type="text" value="TCP/UDP"/>
Port	<input type="text"/>
Description	<input type="text" value="Optional"/>
Enable	<input checked="" type="checkbox"/>

[Cancel](#) [Apply](#)

- **Protocol:** Select the network protocol (TCP, UDP, or TCP/UDP) for the port. This determines how data is transmitted for the service associated with the port.
- **Port:** Enter the specific port number you want to open.
- **Description (Optional):** Add a brief note to describe the purpose of this open port (e.g., “Web Server” or “FTP Service”) for easier management.
- **Enable:** Toggle this switch to activate or deactivate the port forwarding rule.

15.8 Reset Firmware

If the router malfunctions, you can try resolving the issue by resetting the firmware.

Log in to your router's web admin panel and navigate to **SYSTEM > Reset Firmware**. Click **Delete All and Reboot** to reset the firmware as needed.

Reset Firmware

 In case of malfunction, you can reset router. All your current settings, applications and data will be lost. The process will take about 2 Minutes. DO NOT power off the router during this process.

Delete All and Reboot

Note: All your current settings, applications and data will be cleared. The process will take about 2 minutes. Do not power off the router during this process.

If you fail to access the router's web admin panel, try resetting your router using the physical reset button on the side.

15.9 Advanced Settings

Log in to your router's web admin panel and navigate to **SYSTEM > Advanced Settings**. This page allows you to modify advanced settings in LuCI, which is the default web user interface of OpenWrt. As an open and independent project maintained by OpenWrt, LuCI is provided as-is. GL.iNet is not responsible for LuCI maintenance.

Follow the steps below to log in to the LuCI interface.

1. Click **Install Now**, and it will be installing LuCI interface.

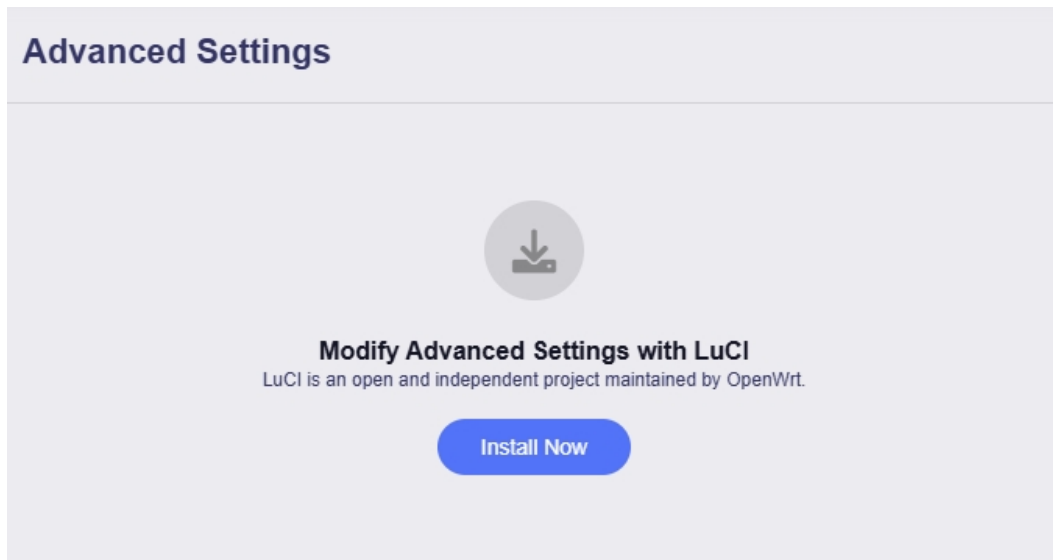

2. Click **Go To LuCI**, and you will be re-directed to the LuCI login page.

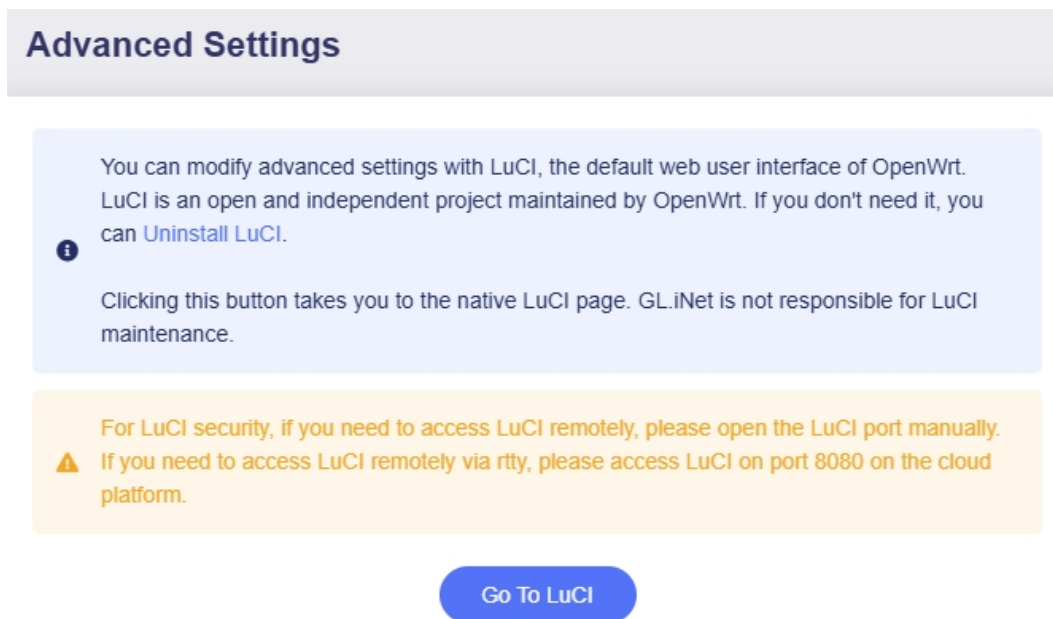

3. Enter the login password, which is the same as the password of the web admin panel.

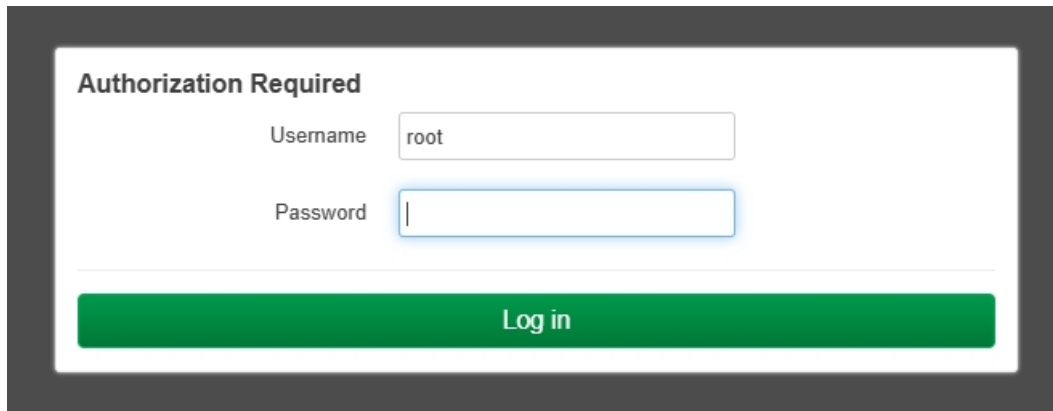

Authorization Required

Username

Password

[Log in](#)

You will then log in to the LuCI interface.

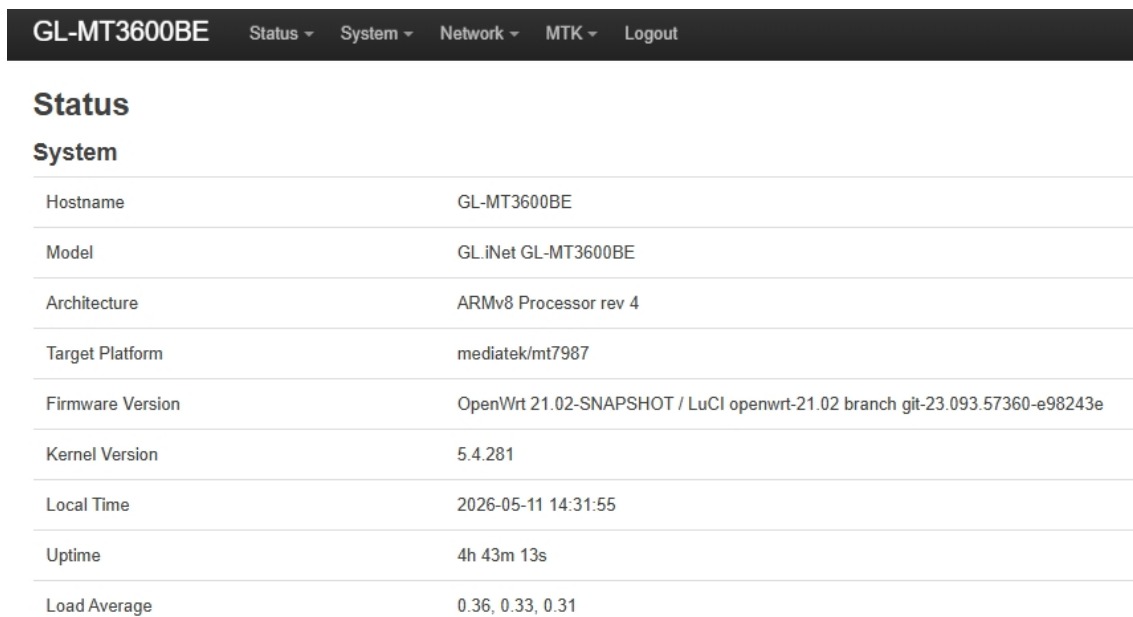

GL-MT3600BE [Status](#) [System](#) [Network](#) [MTK](#) [Logout](#)

Status

System

Hostname	GL-MT3600BE
Model	GL.iNet GL-MT3600BE
Architecture	ARMv8 Processor rev 4
Target Platform	mediatek/mt7987
Firmware Version	OpenWrt 21.02-SNAPSHOT / LuCI openwrt-21.02 branch git-23.093.57360-e98243e
Kernel Version	5.4.281
Local Time	2026-05-11 14:31:55
Uptime	4h 43m 13s
Load Average	0.36, 0.33, 0.31

Regulatory and Legal

Regulatory Compliance

This device complies with part 15 of the FCC Rules. Operation is subject to the following two conditions:

- (1) This device may not cause harmful interference.
- (2) This device must accept any interference received, including interference that may cause undesired operation.

This product complies with the essential requirements and other relevant provisions of Directive 2014/53/EU. A copy of the Declaration of Conformity (DoC) is available at:

<https://www.gl-inet.com/products/certificate/>

RF Exposure Compliance

This equipment complies with FCC/CE RF exposure limits set forth for an uncontrolled environment. To comply with RF exposure requirements, maintain a minimum distance of 20 cm (8 inches) between the device and your body during normal operation.

Trademarks

- Wi-Fi®, Wi-Fi 6™, Wi-Fi CERTIFIED™ are registered trademarks of the Wi-Fi Alliance.
- IEEE® 802.11ax/b/g/n/ac are trademarks of the Institute of Electrical and Electronics Engineers, Inc.
- Other product names, logos, and brands mentioned in this guide are the property of their respective owners.
- GL.iNet and its logo are registered trademarks of GL.iNet Technology (Hong Kong) Ltd.

Limitation of Liability

This product is designed for residential and small office use. GL.iNet shall not be liable for:

- Damages caused by improper installation, misuse, or modification of the device.
- Interference with other electronic equipment due to non-compliance with installation guidelines.
- Loss of data or business interruption resulting from device performance issues, except as required by applicable law.

Software License

The firmware and software included with this device are protected by copyright laws and international treaties. Users are granted a non-exclusive, non-transferable license to use the software solely for operating the device in accordance with this guide. Reverse engineering, decompiling, or modifying the software is prohibited unless permitted by applicable law.

Export Control

This product may be subject to export controls under the laws of the Hong Kong Special Administrative Region of the People's Republic of China (including the Import and Export (Strategic Commodities) Regulations, Chapter 60G of the Laws of Hong Kong), the People's Republic of China (including the Export Control Law of the People's Republic of China and related regulations), and other jurisdictions (e.g., the United States, European Union, Canada, and the United Kingdom). Diversion contrary to applicable laws is prohibited.